



Maanik Mahajan

+91 9871432046
+91 9999329288



JALANDHAR ENTERPRISES

SURGICAL INDUSTRIES

Manufacturer, Supplier & Exporter

15/4/3, Site-IV, Sahibabad Industrial Area,
Ghaziabad, (U.P.)-201010

jesisurgical@gmail.com

www.jemediguard.com



Satish Mahajan +91-9312281439

Naresh Mahajan +91-9810660343



Jullundur Enterprises

ISO 9001:2008 & ISO 13485:2012 & CE CERTIFIED

Manufacturer, Supplier & Exporter

DELHI OFFICE :

1568-A, G-22/23, Bhagirath Palace,
Delhi - 110006, INDIA

Tel.: +91-11-47060283

+91-11-23860035

Email : info@jemediguard.com

Website : www.jemediguard.com

Skype : maanik_je





JULLUNDUR ENTERPRISES

INDEX

S.No	CATEGORY	PAGE
1	HOSPITAL FURNITURE	3
2	OPERATION THEATRE TABLE	16
3	OPERATION THEATRE LIGHT	30
4	MEDICAL AUTOCLAVES	33
5	HOSPITAL HOLLOWARE	42
6	ANESTHESIA MACHINE	50
7	OXYGEN THERAPY EQUIPMENT	57
8	SUCTION MACHINES	60
9	ANESTHESIA EQUIPMENT	64
10	INFANT & BABY CARE EQUIPMENT	86
11	ELECTRO MEDICAL EQUIPMENT	107
12	GENERAL SURGICAL INSTRUMENTS	113
13	OBSTETRICACAL & GYNECOLOGY SURGICAL INSTRUMENTS	177
14	ENT INSTRUMENTS	210
15	ENDOSCOPY EQUIPMENT	268
16	ORTHOPEDIC SURGICAL INSTRUMENTS	284
17	NEURO SURGICAL INSTRUMENTS	333
18	PLASTIC SURGICAL INSTRUMENTS	411
19	OPHTHALMIC SURGICAL INSTRUMENTS	451
20	DERMATOLOGY SURGICAL INSTRUMENTS	511
21	LAPRASCOPY SURGICAL INSTRUMENTS	524
22	PHYSIOTHERAPY EQUIPMENT	541
23	MEDICAL SURGICAL RUBBER PRODUCTS	561
24	MEDICAL NURSING MODELS & CHARTS	572
25	COLD CHAIN EQUIPMENT & VACCINE CARRIER	639
26	LAB EQUIPMENT	652
27	BIO MEDICAL WASTE EQUIPMENT	656
28	XRAY EQUIPMENT	665
29	NATUROPATHY EQUIPMENT	668



India's Biggest Manufacturers of :
HOSPITAL FURNITURE
OPERATION THEATRE LIGHTS



JULLUNDUR ENTERPRISES

(AN ISO 9001 : 2008 CERTIFIED COMPANY)



ICU Bed Electric

- Advance Linear actuator system (04 Pcs Motor, 01Pc Control Box, 01 Pcs Handset)
- Four Pieces individual Side-rails, ABS Moulded.
- ABS Moulded Head and Foot Panel with Locking and corner buffer.
- Framework Made-up of M.S. Tube.
- 4 Section Top made-up of oval perforated CRCA M.S. Sheet.
- Bed Mounted on 5" Castors, 2 with brakes.
- S.S. Telescopic I.V. Rod with 4 Location.
- Holder for Urine Bag.
- Sitting position adjustable.
- Finish : Pretreated & Epoxy Powder Coated.
- Overall Approx. Size: 2090L x 910W x 460-700 MM.
- Positions Obtained by Hand Remot
 - Hi-Low
 - Backrest elevation
 - Kneerest elevation
 - Trendlenburg/Reverse Trendlenburg



Available in wooden colour



5" Castors, 2 with brakes



Hospital Fowler Bed (SS Bows)

Frame work of strong & precise steel tubes having 'H' type legs on 10cms castors - two with brakes. Having four section top of perforated CRCA sheet duly machine press bent with mattress guards. Backrest and knee-rest sections manoeuvred by two separate screws from foot end. Laminated panels fitted with S.S. head & foot bows. Provision for four saline Location. Size : 206L x 90W x 60H cms. Finish : Epoxy Powder Coated.



Hospital Fowler Bed (ABS panels)

- Frame work made of Rectangular M.S. Tube
- 4 Section Top made of perforated M.S. Sheet
- Back Rest, & Knee Rest, manoeuvred by Separate screw from Foot End
- ABS Moulded, Head & Foot Bows
- Bed Mounted on 100 mm Dia Castor Two with Brakes
- Location for Four I. V Rod
- Overall Size : 206L x 90wx60h cms.
- Finish : Epoxy Powder Coated.

ICU Bed Mechanically

- Frame work made of Rectangular M.S. Tube
- 4 Section Top Made of Perforated M.S. Sheet
- Back Rest, Knee Rest, TB/RTB and Hi-Lo Positions manoeuvred by Separate screw from Foot End
- ABS moulded Head & Foot Bows

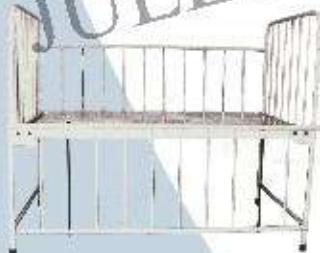

Pediatric Bed



Hospital semi-fowler Bed (SS Bows)

Frame work of strong & precise steel tube having 'H' type legs on PVC stumps. Having two section top of perforated CRCA sheets duly machine press bent, with mattress guards. Laminated panels fitted with S.S. head & foot bows. Backrest section manoeuvred by crank mechanism from foot end. Provision for four locations for I.V. Rod. Size : 206L x 90W x 60H cms. Finish : Pre-treateds , Epoxy Powder Coated.

Surgical Operation Table



Surgical Operation Table Hydraulic Side end Control

Length of the table top	180 to 195 cms.
Width of the table top	50cm.
Minimum height	80 + 5cm.
Maximum height	95 + 5cm.
Hydraulic Lift	22cm.
Lateral Tilt	20 + 2
Longitudinal Tilt	30 + 1

ICU Bed Mechanically (SS Bows)



- Frame work made of Rectangular M.S. Tube
- 4 Section Top made of perforated M.S. Sheet
- BackRest, Knee Rest, TB/RTB and Hi-Lo Positions manoeuvred by Separate screw from Foot End
- S.S. Head & Foot Bows fitted with Laminated/Membrane pressed Panels.
- Collapsible / Swing away safety side Railing.
- Telescopic IV Rod with Four Location
- Rubber Buffers at four Corners
- Bed Mounted on 125mm Dia Castor Two with Beake
- Overall Size-210L x 90W x 60-80Hcms.
- Finish : Epoxy Powder Coated



Stretcher On Trolley with Mattress

- Overall Approx. Size : 180L x 56W x 81H cms.
- Frame work made of Tubular MS Pipe.
- Swing Away type Safety Side Railing.
- Adjustable I.V. Rod, Utility Tray, Cylinder Cage
- Foam padded top
- Trolley mounted on 15cms Dia castors - Two with Brakes
- Epoxy Powder Coated Finish.



Hospital Ward Plain Bed (STD)

Main frame of rectangular pipe, perforated CRCA sheet top tabular head and foot bows of unequal height with vertical tube supports, on PVC stumps. Provision for four saline locations. Pre-treated & Epoxy Powder Coating finish.
Size : 203L x 90W x 60H cms.

Obstetric Labour Table Telescopic (Adjustable Height)

- Approx Dimensions : 72" L x 27" W x 24" - 32" H.
 - Tubular frame work mounted on PVC stumps.
 - Stainless steel top in three sections.
 - Trendlenburg positions adjustable by pneumatic gas spring system.
 - Backrest section adjustable on ratchet.
 - Leg end section can slide under the main section.
 - Height adjustable a pair of knee crutches.
- Pre treated & Epoxy powder coated.
Also available in complete Stainless Steel.



Obstetric Labour Table Mechanically

- Approx. Dimensions : 72" L x 27" W x 30" H
- Tubular frame work mounted on PVC stumps.
- Stainless steel top in three sections.
- Trendlenburg positions adjustable on screw mechanism by handle.
- Backrest section adjustable on ratchet system.
- Height adjustable a pair of Leg holders with straps.
- Complete with self locking traction handle at side, I.V. Rod & mattress.
- Pre Treated & Epoxy powder coated.

Emergency & Recovery Trolley (Hydraulic)

- Approx Size : 210L x 65W x 65-95H cms. Safety side railing, I.V. Rod, storage tray & Cylinder cage.
- Removable X-Ray translucent top with tray for holding X-ray Cassettes adjustable height.
- Trendlenburg / Rev. Trendlenburg, 15 cms dia castors, Corner buffers.
- Pre-treated & Epoxy Powder Coated.





Invalid wheel chair Folding
(Detachable Armrest & Footrest)



Photo therapy Unit with baby bassinet
(Double Side)



Photo therapy Unit



Instrument Cabinet

- Made from CRC sheet three side closed
- Front glass door and glass shelves
- Pre-treated and Epoxy Powder Coated



Baby Bassinet

- Preprex transparent Crib with mattress.
- Trendlenburg / Rev. Trendlenburg, 5 Cms. castors I.V. Rod.
- Pretreated & Epoxy Powder Coated.



Baby Cradle

- 136" x 15" x 39"
- M.S. tubular pipe.
- Stand fitted with PVC stumps.
- Wire mesh hanging cradle.
- Pre-treated and Epoxy Powder coated.



Baby Bassinet

- (with Utility Box)
- Preprex transparent Crib with mattress.
- Trendlenburg / Rev. Trendlenburg.
- Laminated cupboard with plate form, 5 cms castors I.V. Rod.
- Pretreated & Epoxy Powder Coated.



Examination couch with cabinet & drawers

- Overall Approx. Size : 187L x 51W x 81H.
- Adjustable backrest by gas spring system.
- Two section foam padded, upholstered top.
- Three Drawers. Three Cabinets
- Tray for B.P. apparatus.
- Pre-treated & Epoxy Powder coated.



Examination table plain

- (183 L x 60 W x 81 H cms.)
- Frame work of CRC tubes.
- Legs fitted with PVC stumps.
- 5 cms foam cushioned top covered with rexine.
- Pre-treated and Epoxy Powder Coated.



Patient Stool Revolving Cushioned Top

- MS tubular 4 legs fitted with PVC stumps footrest ring support.
- 18" x 27" adjustable height by screw.
- Epoxy powder coated.
- Also available S.S. legs & top.



Visitor Stool

- (12" x 12" x 20")
- M.S. Tubular frame fitted with PVC stump.
- CRC sheet duly double press bent.
- Pre-treated and Epoxy Powder Coated.



Patient Stool Revolving S.S. Top

- M.S. Tubular four legs fitted with PVC stumps.
- Foot ring supports.
- 18" to 27" adjustable height S.S. top through screw.
- Pre-treated and Epoxy Powder Coated.
- Also available in S.S. legs & Top.



Foot Step Single

- (18" x 9" x 9")
- M.S. Tubular legs fitted with PVC stump.
- M.S. top fixed with rubber matting and aluminum beedings.
- Pre-treated and Epoxy Powder Coated.



Crash Cart

- Overall approx size : 940 mmL x 490 mmW x 1535 mmH.
- Six removable bins & two Polystyrene. Storage unit with three drawers each. 125mm dia castors, Corner buffers.
- Oxygen Cylinder Holder, electric lamp.
- I.V. rod, cardiac massage board & 3 laminated shelves.
- Pre-treated & epoxy powder coated.
- Also available in S.S. frame & Sheeted.



Bed Side Locker (STD)

(16" L x 16" W x 32" H)

- Tubular pipe construction fitted PVC stumps assembled to M.S. cupboard.
- Stainless steel top.
- Epoxy Powder Coated.



Bed Side Locker (Deluxe)

(16" L x 16" W x 32" H)

- CRCA Sheet constructions. Having one Box and one drawer
- S.S. Top with three Sides raise edges.
- Epoxy Powder Coated.



Over Bed Table (Manual)

- Rectangular frame work mounted on 5 cms castors.
- 30" x 16" Laminated top adjustable by side knob.
- Pre-treated and Epoxy Powder Coated.



Saline Stand

- M.S. Tubular Pipe.
- Five leg base with 5 cms castors.
- S.S. adjustable rod from 137 to 240 cms with double hook
- Pre-treated and Epoxy Powder Coated.
- Also available in S.S. outer pipe and rod.



Over Bed Table Sunmica Top

(42" L x 16" W x 39" H)

- Tubular frame work mounted on 5 cms castors.
- Fixed Laminated top 30" x 16".
- Pre-treated and Epoxy Powder Coated.



Foot Step Double

(18" x 18" x 18")

- M.S. Tubular Frame fitted with PVC stump.
- CRC sheet duly double press bent.
- Pre-treated and Epoxy Powder Coated.



Cylinder Trolley

- Tubular frame work.
- Two 10 cms castors.
- M.S. sheet base plate.
- Pre-treated and Epoxy powder coated finish.
- A - For small cylinder.
- B- For large cylinder.



Dressing Trolley

(76Lx46Wx81Hcms.)

- M.S. Tubular Frame.
- S.S. Shelves with railing 10 cms. castors with bowl & bucket
- Epoxy Powder Coated
- Fixed construction
- Also available in S.S. Frame & shelves

Monitor Trolley

- Overall approx size : 800mm L x 600mm W x 1408mm H
- One drawer & 4 shelves
- Oxygen cylinder cage & I.V. Rod.
- Mounted on 125mm dia casters
- Switch & socket panel for medical equipment.
- Epoxy Powder coated.



Hand Wash Basin Stand (Single) With Basin

- Five Legs base mounted on 5 cms dia castors.
- With Two approx. 35 cms S.S. basin.
- Pre-treated and Epoxy Powder Coated.
- Also available in S.S. pipe & rings.



Hand Wash Basin Stand (Double Basin)

- Five Legs base mounted on 5 cms dia castors.
- With Two approx. 35 cms S.S. basin.
- Pre-treated and Epoxy Powder Coated.
- Also available in S.S. pipe & rings.



Soiled Linen Trolley With Canvas Bag

- Frame Work of CRC tube mounted on 10 cms castors.
- Superior Quality canvas bag.
- Pre-treated and Epoxy powder coated finish.



Soiled Linen Trolley With Plastic Bucket

- Push handle at one end.
- Frame work of CRC tube mounted on 10 cms castors.
- Superior quality plastic bucket.
- Pre-treated & Epoxy powder coated.
- Also available in S.S. frame.



Linen Change Trolley

- MS Tubular frame mounted on 10 cms Dia castors.
- Three shelves made of MS Sheet.
- A Canvas Bag fitted on front side.
- Epoxy Powder Coated Finish.



Over Bed Table (Adjustable by Gear Handle)



Mayo's Instrument Trolley with S.S. Tray

- Tray Size S.S. : 56 L x 40 W cms
- Rectangular CRC tubes mounted on 5 cms castors, height adjustable by side knob.
- Pre-treated and Epoxy Powder Coated Finish.
- Also available in S.S. frame & tray.



Medicine Trolley with 4 Drawer

- Overall Approx. Size : 76 L x 46 W x 81 H cms.
- Frame work of MS tubes mounted on 10cms castors.
- Two SS shelves with three side railing on top shelf.
- Two drawer under the each shelf.
- Epoxy Powder Coated Finish.



Instrument Trolley (2 Shelves)



Instrument Trolley (2 Shelves with 4 side railing)



Instrument Mayo Trolley Over the OT Table (Mechanically)



Gynaec Examination Table (Back Rest)



Examination Table (2 section)

- Approx. Dimensions : 72"L x 24"W x 32"H
- Frame work Rectangular & Square Steel tube
- Adjustable Back Rest by hand lever.
- 2 Section Cushioned top
- Legs fitted in PVC stands
- Pre-treated & Epoxy Power Coated



Attendant Bed

- Overall Size : 180Lx60Wx46H cms.
- Frame works made of Rectangular / Square M.S. Tube
- 5cm Foam Padded Top covered with Rexine
- Legs fitted with PVC Stumps
- Finish : Epoxy powder Coated



Suction Apparatus 1/4 HP

- Ward care Suction Unit
- Powder Coated MS chassis.
- Noise level of suction apparatus is 50 dB \pm 03 dB.
- Electrical requirement : 220 - 230VAC, 50Hz, 1 Phase
- Ideal for medical & surgical procedures
- Rotary Vane or Diaphragm Vacuum Pump with \approx 710 \pm 10mm Hg.
- Free air displacement 25 - 30 ltrs / min
- Heavy duty HN - 50 antistatic castors
- 180 Watt 1440 RPM, 0.25 H.P. Electric Motor.
- 76mm Vacuum Gauge.
- Non collapsible PVC tubing
- 2x1.5 Ltrs. Polycarbonate jars with overflow safety
- Bacterial filter fitted on top
- All parts coming into contact with secretion are autoclave safe



Bed Side Screen (4 Panels)

- (66" H x 96" L)
- Tubular frame work mounted on 5 cms castors
- with curtains
- Pre-treated and Epoxy Powder coated



Stretcher Trolley

- (213 L x 56 W x 31 H cms.)
- Frame work of CRD tubes mounted on 15 cms castors.
- Removable stretcher top with chrome plated handle.
- Pre-treated and Epoxy Powder coated finish without Mattress.



Vertical High Pressure Steam Sterilizer Autoclave



Auto Clave (Portable) Single/ Double Drum



Aerosol Disinfectant

Surgical Operating Lights



Examination Lamp (Flexible Pipe)

JULLUNDUR ENTERPRISES

Folding Stretcher Two Fold

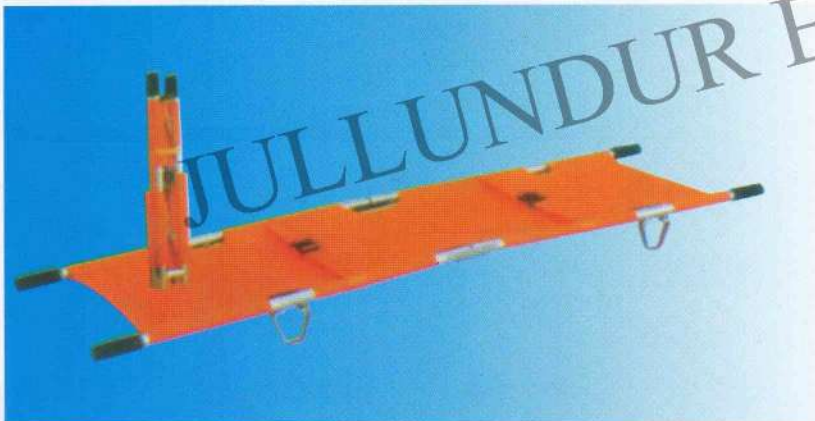

- ★ Foldable stretcher made of heavy quality extra strength MS / Aluminium / Steel Poles
- ★ Stretcher foldable widthwise with the help of MS cross bars
- ★ Stretcher also foldable lengthwise with the help of metal folder.
- ★ Supported on spreader MS Feet.
- ★ Fitted with extra strength waterproof rugged canvas / Matty top
- ★ Nylon strips to provide extra strength.
- ★ Handles fitted with rubber grips
- ★ Stretcher can be carried in a bag, provided with the stretcher
- ★ Dimensions (in cm)
 - Open : 203L*55W*10H
 - Close : 101L*16W*8H
- ★ Extra :
 1. Belts to tie up the patient
 2. Also available in 3-Fold i.e. foldable lengthwise twice.

Folding Stretcher Three Fold

Unfolded size	: 203L X 55W X 12H Cms
Folded-size	: 91L X 18W X 11H Cms
Net Wt.	: 5 Kg
Gross Wt.	: 6Kg

JULLUNDUR ENTERPRISES

Folding Stretcher Regular



- ★ Foldable stretcher made of MS / Aluminium / Steel Poles
- ★ Stretcher foldable widthwise with the help of MS cross bars
- ★ Supported on spreader MS Feet.
- ★ Fitted with rugged canvas / Matty top
- ★ Handles fitted with rubber grips
- ★ Dimensions (in cm) 213L*55W*10H
- ★ Extra :
 1. Belts to tie up the patient
 2. Nylon strips on canvas/Matty top to provide extra strength.

Folding Stretcher Four Fold

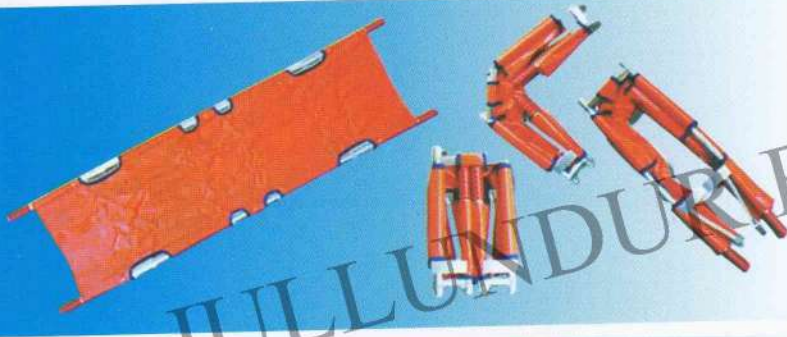

- Foldable stretcher made of heavy quality extra strength MS/SS/Aluminium poles.
- Stretcher foldable width wise with the help of MS cross bars.
- Stretcher also foldable lengthwise Thrice with the help of metal folder.
- Supported on Specially designed spreader feet
- Fitted with extra strength nylon base synthetic fibre.
- Nylon strips on canvas top to provide extra strength.
- Handles fitted with rubber grips.
- Stretcher can be carried in a bag, provided with the stretcher.

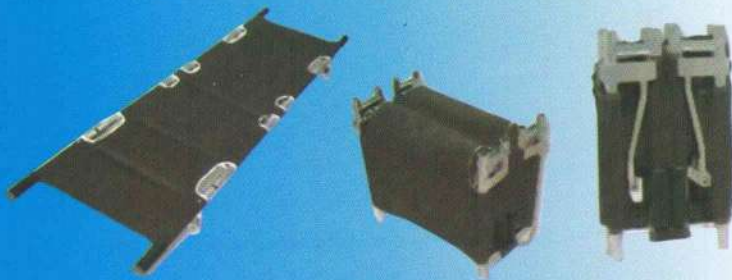

Unfolded size	: 210L X 53W X 12H Cms
Folded size	: 61L X 30W X 12H Cms
Net Wt.	: 6 Kg
Gross Wt.	: 7 Kg

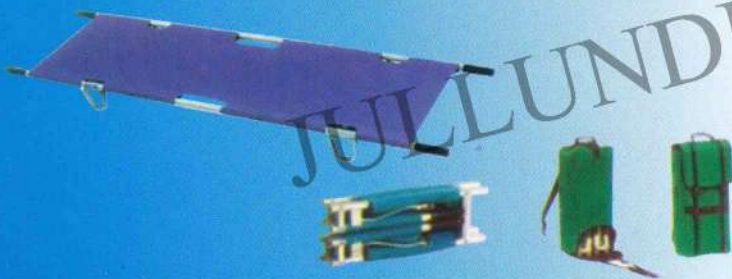

JULLUNDUR ENTERPRISES



Folding Stretcher Regular(Canvas)

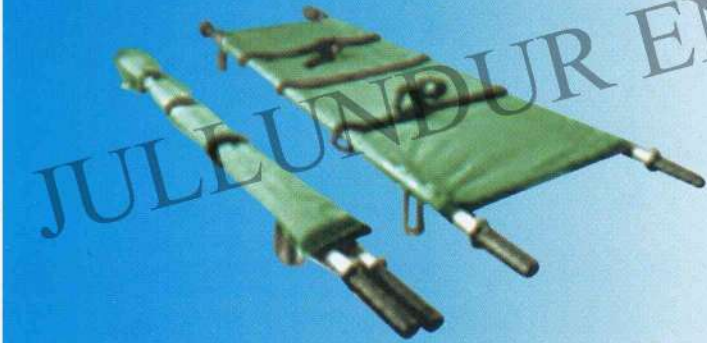

Stretcher 2- fold



Surgon Aprons



Mattress

As Per Size & Quality

JULLUNDUR ENTERPRISES

JULLUNDUR ENTERPRISES



LxWxH
 Unfolded Size : 210x53x12 cms.
 Folded Size : 61x30x12 cms.
 Self Weight : 6 kgs.
 Load Capacity : 159 kgs.

FOLD AWAY STRETCHER 4 FOLD



LxWxH
 Unfolded Size : 221x53x15 cms.
 Folded Size : 110x18x11 cms.
 Self Weight : 5 kgs.
 Load Capacity : 159 kgs.

FOLD AWAY STRETCHER 2 FOLD



HEAD IMMOBLIZER



SPINE BOARD

LxWxH
 Size : 184x45x7 cms.
 Self Weight : 7.5 kgs.
 Load Capacity : 159 kgs.



Self Weight : 7 kgs.
 Load Capacity : 159 kgs.

SCOOP STRETCHER
 X-RAY TRANSLUCENT



LxWxH
 Unfolded Size : 214x42x7 cms.
 Folded Size : 167x42x7 cms.
 Self Weight : 9 kgs.
 Load Capacity : 159 kgs.

ALUMINUM SCOOP STRETCHER



LxWxH
 Unfolded Size : 70x52x91 cms.
 Folded Size : 90x54x17 cms.
 Self Weight : 8 kgs.
 Load Capacity : 159 kgs.

STAIR CHAIR

JULLUNDUR ENTERPRISES



AMBULANCE STRETCHER
WITH CHAIR POSITION

LxWxH
High Position : 191x53x82 cms.
Low Position : 191x53x25 cms.
Self Weight : 39 kgs.
Load Capacity : 181 kgs.

TSR Watermark Image - www.watermark-image.com - Unregistered version



AMBULANCE STRETCHER

LxWxH
High Position : 195x55x85 cms.
Low Position : 191x55x25 cms.
Self Weight : 40 kgs.
Load Capacity : 181 kgs.

JULLUNDUR ENTERPRISES



TRANSFUSION CHAIR S.S.



TRANSFUSION CHAIR



TRANSFUSION CHAIR DELUXE



BED SIDE CABINET
DELUXE



FOOD TABLE
GAS SPRING OPERATED



FOOD TABLE



**India's Biggest Manufacturers of :
OPERATION THEATRE TABLE**



JULLUNDUR ENTERPRISES

(AN ISO 9001 : 2008 CERTIFIED COMPANY)



JULLUNDUR ENTERPRISES

Deluxe Table

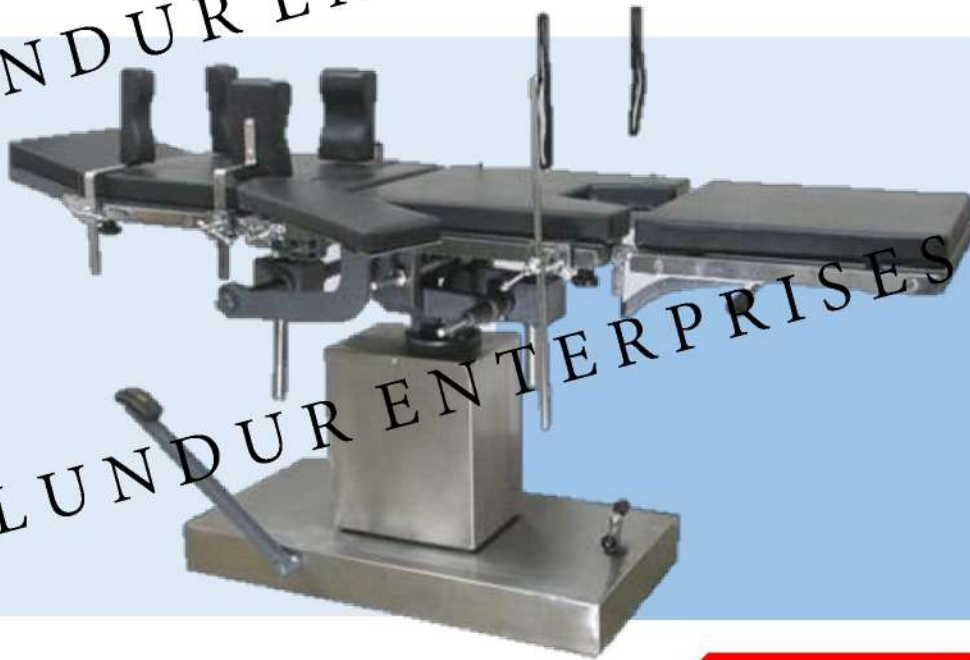

Steel Quality 202 Grade SS

Technical Data

Length of Table	1905mm
Width of Table Top	520mm
Minimum Height	Min. 750mm
Maximum Height	Max. 1000mm
Trendelburg	25°
Reverse Trendelburg	25°
Lateral Tilt	±20°
Back Section Up	90°±10%
Head Section	±60°
Leg Section Down	0° 90°
Floor Locking System	yes



JULLUNDUR ENTERPRISES

Super Deluxe Table SS



Steel Quality 202 Grade SS

Technical Data

Length of Table	1005mm
Width of Table Top	520mm
Minimum Height	Min. 750mm
Maximum Height	Max. 1000mm
Trendelburg	25°
Reverse Trendelburg	25°
Lateral Tilt	±20°
Back Section Up	90° ±10°
Head Section	±60°
Leg Section Down	0° 90°
Floor Locking System	yes



JULLUNDUR ENTERPRISES

Deluxe Table 304 SS
Hydraulic



Steel Quality 304 Grade SS

Technical Data	
Length of Table	1905mm
Width of Table Top	520mm
Minimum Height	Min. 750mm
Maximum Height	Max. 1000mm
Trendelburg	25°
Reverse Trendelburg	25°
Lateral Tilt	±20°
Back Section Up	90°±10%
Head Section	±60°
Leg Section Down	0° 90°
Floor Locking System	yes



JULLUNDUR ENTERPRISES

Classic Model

JULLUNDUR ENTERPRISES



JULLUNDUR ENTERPRISES

Technical Data

Length of Table	1905mm
Width of Table Top	520mm
Minimum Height	Min. 750mm
Maximum Height	Max. 1000mm
Trendelburg	25°
Reverse Trendelburg	25°
Lateral Tilt	±20°
Back Section Up	90°±10%
Head Section	±10°
Leg Section Down	0° 90°
Floor Locking System	yes

Steel Quality 202 Grade SS

JULLUNDUR ENTERPRISES

JULLUNDUR ENTERPRISES



JULLUNDUR ENTERPRISES

Deluxe Table Radiolucent top



Technical Data

Length of Table	1905mm
Width of Table Top	520mm
Minimum Height	Min. 750mm
Maximum Height	Max. 1000mm
Trendelburg	25°
Reverse Trendelburg	25°
Lateral Tilt	±20°
Back Section Up	90° ±10°
Head Section	±60°
Leg Section Down	0° 90°
Floor Locking System	yes

Steel Quality 202 Grade SS



JULLUNDUR ENTERPRISES

Arm Table Hydraulic

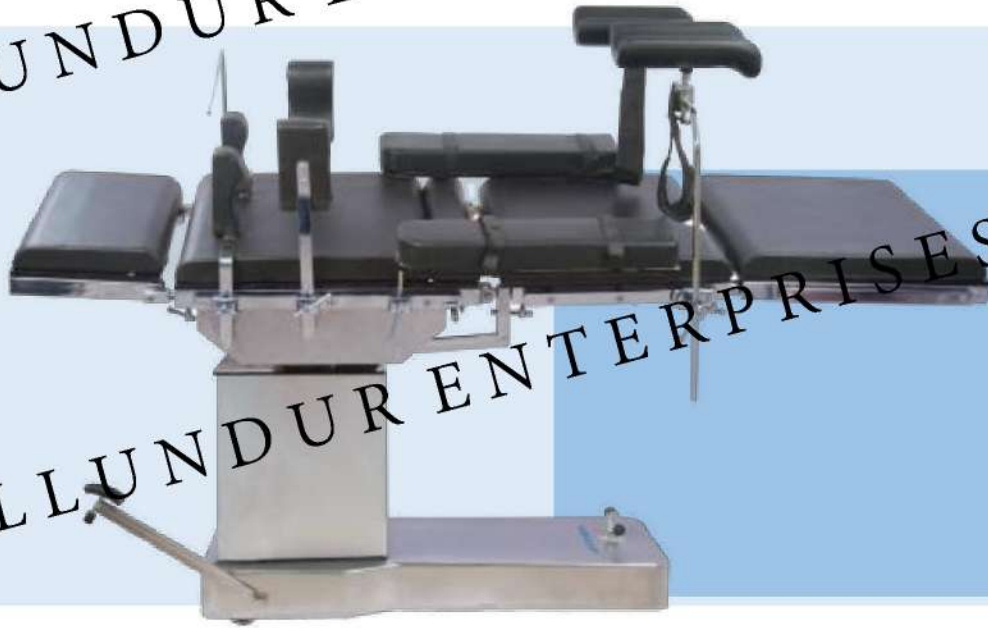

Steel Quality 202 Grade SS

Technical Data

Length of Table	2040mm
Width of Table Top	530mm
Minimum Height	Min. 750mm
Maximum Height	Max. 1000mm
Trendelburg	25°
Reverse Trendelburg	25°
Lateral Tilt	±20°
Back Section Up	90° +10%
Head Section	±60°
Leg Section Down	0° 90°
Floor Locking System	yes



JULLUNDUR ENTERPRISES

Operating Table Semi electric

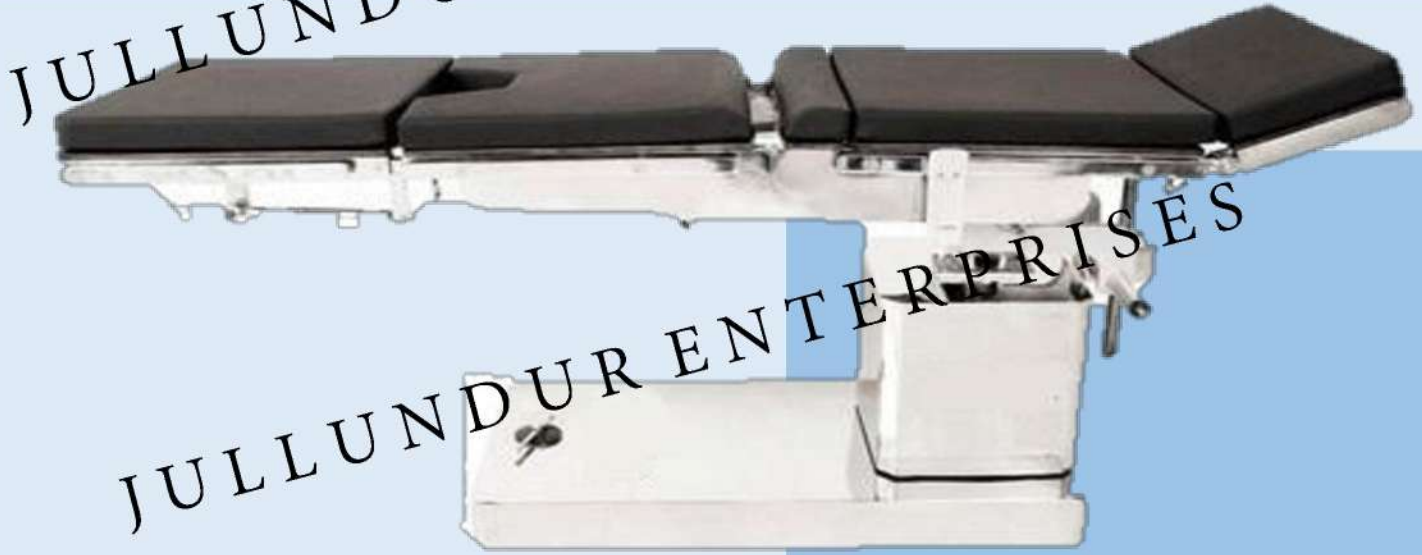

Steel Quality 202 Grade SS

Technical Data

Length of Table	2040mm
Width of Table Top	530mm
Minimum Height	Min. 750mm
Maximum Height	Max. 1000mm
Trendelburg	25°
Reverse Trendelburg	25°
Lateral Tilt	±20°
Back Section Up	90° ±10%
Head Section	±60°
Leg Section Down	0° 90°
Floor Locking System	yes



JULLUNDUR ENTERPRISES

Electric OT table with ortho attachment



Technical Data

Length of Table	2040mm
Width of Table Top	530mm
Minimum Height	Min. 750mm
Maximum Height	Max. 1000mm
Trendelburg	25°
Reverse Trendelburg	25°
Lateral Tilt	±20°
Back Section Up	90° ±10%
Head Section	±60°
Leg Section Down	0° 90°
Floor Locking System	yes

Steel Quality 202 Grade SS



JULLUNDUR ENTERPRISES

Electric OT Table
with remote

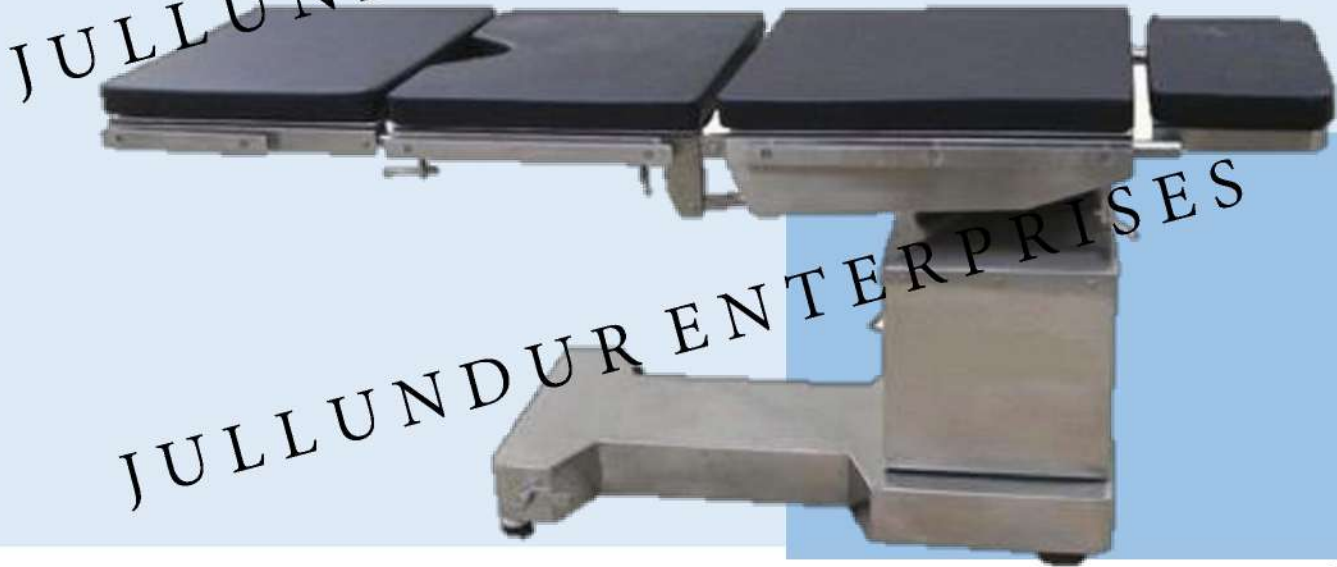

Steel Quality 202 Grade SS

Technical Data

Length of Table	2040mm
Width of Table Top	530mm
Minimum Height	Min. 750mm
Maximum Height	Max. 1000mm
Trendelburg	25°
Reverse Trendelburg	25°
Lateral Tilt	±20°
Back Section Up	90° ±10%
Head Section	±60°
Leg Section Down	0° 90°
Floor Locking System	yes



JULLUNDUR ENTERPRISES

Gynecology OT Table (Hydraulic)



Steel Quality 202 Grade SS

Technical Data

Length of Table	1935mm
Width of Table Top	520mm
Minimum Height	Min. 750mm
Maximum Height	Max. 1000mm
Trendelburg	25°
Reverse Trendelburg	25°
Lateral Tilt	±20°
Back Section Up	90°-110°
Head Section	±60°
Leg Section Down	0°-90°
Floor Locking System	yes



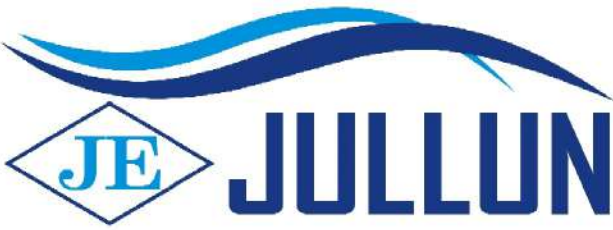

JULLUNDUR ENTERPRISES

Gynecology OT Table Semi Electric



Steel Quality 202 Grade SS

Technical Data

Length of Table	2040mm
Width of Table Top	530mm
Minimum Height	Min. 750mm
Maximum Height	Max. 1000mm
Trendelburg	25°
Reverse Trendelburg	25°
Lateral Tilt	±20°
Back Section Up	90° ±10%
Head Section	±60°
Leg Section Down	0° 90°
Floor Locking System	yes



JULLUNDUR ENTERPRISES

POSITIONS



Height Down



Height Up



Lateral Tilt - Left



Lateral Tilt - Right



Trendelenburg



Reverse Trendelenburg





JULLUNDUR ENTERPRISES

POSITIONS OF OT TABLES



Normal Position



General Surgery



General Surgery



Trendelenburg



Rev. Trendelenburg



Lateral Tilt Left



Lateral Tilt Right



Lower Back Section UP



Lower Back Section Down



Upper Back Section Up



Upper Back Section Down



Head Section Up



Head Section Down



Leg Section Up



Leg Section Down



**India's Biggest Manufacturers of :
OPERATION THEATRE LIGHTS**



JULLUNDUR ENTERPRISES

(AN ISO 9001 : 2008 CERTIFIED COMPANY)

4 REFLECTORS LED OT LIGHT (SINGLE ARM)

MODEL: JE-LED-OT-C-4-76



Technical Data

Intensity	1,20,000±10% LUX
Intensity Satellite	1,20,000±10% LUX
Spot Diameter	100-150 mm
Depth Illumination	10-15 cm
Colour Temperature	4000-4850 K
Colour Rendering Index	91Ra
Focusing	Manual
LED Average Life	>50000HRS.
Diameter of Light	580mm
Intensity Control	DIGITAL
Power Supply	220V/50Hz Ac
Power Consumption	40 Watt
No. of led	76 led

with Sterilizable handle

4 REFLECTORS LED OT LIGHT (SINGLE ARM)

MODEL: JE-LED-OT-M-4-76



Technical Data

Intensity	1,20,000±10% LUX
Intensity Satellite	1,20,000±10% LUX
Spot Diameter	100-150 mm
Depth Illumination	10-15 cm
Colour Temperature	4000-4850 K
Colour Rendering Index	91Ra
Focusing	Manual
LED Average Life	>50000HRS.
Diameter of Light	580mm
Intensity Control	DIGITAL
Power Supply	220V/50Hz Ac
Power Consumption	40 Watt
No. of led	76 led

with Sterilizable handle

EXAMINATION MINOR LED OT LIGHT



**MODEL: JE-LED-EXAM-
M-1-19**

Technical Data

Intensity	40,000±10% LUX
Intensity Satellite	40,000±10% LUX
No. of Led	19
Spot Diameter	100-150 mm
Depth Illumination	10-15 cm
Colour Temperature	4000-4850 K
Colour Rendering Index	91Ra
LED Average Life	>50000HRS.
Diameter of Light	150mm
Intensity Control	DIGITAL
Power Supply	220V/50Hz Ac
Power Consumption	40 Watt
No. of led	19 led

ISO
9001-2008



**Address : 1568-A, G-22-23,
Bhagirath Palace, Chandni Chowk
Delhi 110006, India**

**Mobile : +91 9312281439
+91 9810660343
+91 9871432046**

**Email : info@jemediguard.com
Website : www.jemediguard.com**



AUTOCLAVES CATALOG



JULLUNDUR ENTERPRISES

STAINLESS STEEL & ALUMINIUM AUTOCLAVES



**AUTOCLAVES ALUMINIUM
WINGED NUTS TYPE**

Autoclave Portable Aluminium Wing Nut Type (Sterilizer Dressing Pressure Type)

Size/Capacity: 21ltr – 39ltr.

Seamless construction ensures bacteria free environment. The Unit is made of Aluminium mirror finish. Equipped with Pressure Gauge, Safety Valve, Double safety Valve, Steam Release Valve, Vacuum Release Valve, Rubber Gasket, Inner Container, Inner Tripod stand and Mild Steel Stand for Autoclave.

Models/ Variants Capacity

21ltr	Non - Electrical
21ltr	Electrical
25ltr	Non - Electrical
25ltr	Electric
27ltr	Non - Electric
27ltr	Electric
30ltr	Non - Electric
30ltr	Electric
39ltr	Non - Electric
39ltr	Electric

Autoclave Portable Stainless Steel Wing Nut Type (Sterilizer Dressing Pressure Type)

Size/Capacity: 21ltr – 39ltr.

Seamless/ Seam weld construction ensures bacteria free environment. The unit is made of Stainless Steel shell, Ring of aluminium, Lid of Stainless Steel combined with Aluminium. The Unit Equipped with Pressure Gauge, Safety Valve, Double safety Valve, Steam Release Valve, Vacuum Release Valve, Rubber Gasket, Inner Container, Inner Tripod stand and Mild Steel Stand for Autoclave.

Models/ Variants Capacity

21ltr	Non - Electrical
21ltr	Electrical
27ltr	Non - Electrical
27ltr	Electric
39ltr	Non - Electric
39ltr	Electric



**AUTOCLAVES STAINLESS STEEL
WINGED NUTS TYPE**

JULLUNDUR ENTERPRISES

STAINLESS STEEL & ALUMINIUM AUTOCLAVES



Autoclave Portable Aluminium Pressure Cooker Type (Sterilizer Dressing Pressure Type)

Size/Capacity: 6ltr – 75ltr

Seamless construction ensures bacteria free environment. The unit is made of Aluminium mirror finish. Equipped with Pressure Gauge, Safety Valve, Double safety Valve, Steam Release Valve, Vacuum Release Valve, Rubber Gasket, Inner Container, Inner Tripod stand and Mild Steel Stand for Autoclave.

AUTOCLAVES ALUMINIUM 'P' TYPE

Size (Inch/mm)	Capacity	
9" x 6" (225x160mm)	6ltr	Non - Electrical
9" x 7½" (225x190mm)	7.5ltr	Non - Electrical
9" x 9" (225x225mm)	9ltr	Non - Electrical
9" x 9" (225x225mm)	9ltr	Electrical
9" x 10" (225x250mm)	10ltr	Non - Electrical
9" x 10" (225x250mm)	10ltr	Electrical
9" x 11" (225x275mm)	12ltr	Non - Electrical
9" x 11" (225x275mm)	12ltr	Electrical
9½" x 17" (240x430mm)	16ltr	Non - Electrical
9½" x 17" (240x430mm)	16ltr	Electrical
12" x 12" (300x300mm)	21ltr	Non - Electrical
12" x 12" (300x300mm)	21ltr	Electrical
12" x 14" (300x350mm)	25ltr	Non - Electrical
12" x 14" (300x350mm)	25ltr	Electrical
12" x 16" (300x400mm)	30ltr	Non - Electrical
12" x 16" (300x400mm)	30ltr	Electrical
12" x 22" (300x550mm)	40ltr	Non - Electrical
12" x 22" (300x550mm)	40ltr	Electrical
14" x 13" (350x325mm)	32ltr	Non - Electrical
14" x 13" (350x325mm)	32ltr	Electrical
14" x 15" (350x380mm)	39ltr	Non - Electrical
14" x 15" (350x380mm)	39ltr	Electrical
14" x 17" (350x430mm)	43ltr	Non - Electrical
14" x 17" (350x430mm)	43ltr	Electrical
18" x 14" (450x350mm)	55ltr	Non - Electrical
18" x 14" (450x350mm)	55ltr	Electrical
18" x 16" (450x400mm)	63ltr	Non - Electrical
18" x 16" (450x400mm)	63ltr	Electrical
18" x 18" (450x450mm)	75ltr	Non - Electrical
18" x 18" (450x450mm)	75ltr	Electrical

JULLUNDUR ENTERPRISES

STAINLESS STEEL & ALUMINIUM AUTOCLAVES



AUTOCLAVES STAINLESS STEEL 'P' TYPE

Autoclave Portable Stainless Steel Pressure Cooker Type (Sterilizer Dressing Pressure Type)

Size/Capacity: 9ltr - 39ltr

Seamless construction ensures bacterial free environment. The unit is made of Stainless steel. Equipped with Pressure Gauge, Safety Valve, Double Safety Valve, Steam Release Valve, Vacuum Release Valve, Rubber Gasket, Inner Container, Inner Tripod Stand and Mild Steel Stand for Autoclave.

Size (Inch/mm)	Capacity	
9"x9" (225x225mm)	9ltr	Non - Electrical
9"x9" (225x225mm)	9ltr	Electrical
9"x11" (225x275mm)	11ltr	Non - Electrical
9"x11" (225x275mm)	11ltr	Electrical
9"x16" (225x400mm)	16ltr	Non - Electrical
9"x16" (225x400mm)	16ltr	Electrical
12" x12" (300x300mm)	21ltr	Non - Electrical
12" x12" (300x300mm)	21ltr	Electrical
12" x14" (300x350mm)	25ltr	Non - Electrical
12" x14" (300x350mm)	25ltr	Electrical
12" x22" (300x550mm)	40ltr	Non - Electrical
12" x22" (300x550mm)	40ltr	Electrical
14" x13" (350x525mm)	34ltr	Non - Electrical
14" x13" (350x525mm)	34ltr	Electrical
14" x16" (350x380mm)	39ltr	Non - Electrical
14" x16" (350x380mm)	39ltr	Electrical

JULLUNDUR ENTERPRISES

STAINLESS STEEL & ALUMINIUM AUTOCLAVES

VERTICAL AUTOCLAVES



S.S. DOUBLE WALLED AUTOCLAVE

Autoclave Vertical Stainless Steel Nut Locking (Sterilizer Dressing Pressure Type)

Size/Capacity: 23ltr –40ltr

Double Wall Single Chamber Autoclave. The Inner Chamber, Outer Wall, Lid, Ring made of Stainless Steel. The instrument is absolutely leak proof .Equipped with Pressure Gauge, Safety Valve, Double Safety Valve, Steam Release Valve, Vacuum Release Valve, Rubber Gasket, Inner Container, Inner Tripod Stand and Mild Steel Legs for Autoclave. The autoclave can hold the in between 5psi to 20 psi.

Size (Inch)	Capacity	
10" x 18"	23ltr	Electrical
12" x 22"	40ltr	Electrical
14" x 22"	52ltr	Electrical
14" x 25"	60ltr	Electrical
16" x 24"	75ltr	Electrical
18" x 24"	95ltr	Electrical
22" x 30"	180ltr	Electrical



S.S. DOUBLE WALLED AUTOCLAVE

Autoclave Vertical Stainless Steel Nut Locking (Sterilizer Dressing Pressure Type)

Size/Capacity: 23ltr –40ltr

Double Wall Single Chamber Autoclave. The Inner Chamber and Outer Wall are made of Stainless Steel, Ring Made of Aluminium, Lid made of Stainless Steel combined with Aluminium. The instrument is absolutely leak proof .Equipped with Pressure Gauge, Safety Valve, Double Safety Valve, Steam Release Valve, Vacuum Release Valve, Rubber Gasket, Inner Container, Inner Tripod Stand and Mild Steel Legs for Autoclave. The autoclave can hold the in between 5psi to 20 psi.

Size (Inch)	Capacity	
10" x 18"	23ltr	Electrical
12" x 22"	40ltr	Electrical

JULLUNDUR ENTERPRISES

VERTICAL AUTOCLAVES

Double Wall Vertical Autoclave Radial Locking

Size/Capacity: 40ltr -180ltr

Double Wall Chamber Autoclave. The Inner Chamber and Outer Wall made of Stainless Steel, Ring Made of Stainless Steel/ Mild Steel. The lid is made of Stainless steel tightened by radial arms through a steering wheel made of Chrome plated Mild Steel. The instrument is absolutely leak proof. Equipped with Pressure Gauge, Safety Valve, Double Safety Valve, Steam Release Valve, Rubber Gasket, Inner Container, S.S Bucket, and Mild Steel Legs for Autoclave. The Autoclave can hold the in between 5psi to 20 psi.



S.S. DOUBLE WALLED AUTOCLAVE

Size (Inch)	Capacity	
10" x 18"	23 ltr	Electrical
12" x 22"	40 ltr	Electrical
14" x 22"	52 ltr	Electrical
14" x 25"	60 ltr	Electrical
16" x 24"	75 ltr	Electrical
18" x 24"	95 ltr	Electrical
22" x 30"	180ltr	Electrical

Tripe Wall Vertical Hi - Pressure Radial Locking

Size/Capacity: 40ltr -180ltr

Triple Wall Double Chamber Autoclave. The Inner Chamber, Middle Chamber and Outer Wall made of Stainless Steel, Ring Made of Stainless Steel/ Mild Steel. The lid is made of Stainless steel tightened by radial arms through a steering wheel made of Chrome plated Mild Steel. The instrument is absolutely leak proof. Equipped with Pressure Gauge, Safety Valve, Double Safety Valve, Steam Release Valve, Rubber Gasket, Inner Container, S.S Bucket, and Mild Steel Legs for Autoclave. The Autoclave can hold the in between 5psi to 20 psi.

Size (Inch)	Capacity	
12" x 22"	40 ltr	Electrical
14" x 22"	52 ltr	Electrical
14" x 25"	60 ltr	Electrical
16" x 24"	75 ltr	Electrical
18" x 24"	95 ltr	Electrical
22" x 30"	180ltr	Electrical



TRIPLE WALL AUTOCLAVE

JULLUNDUR ENTERPRISES

VERTICAL AUTOCLAVES



Triple Wall Vertical Hi-Pressure Nut Locking

Size/Capacity: 40ltr -180ltr

Triple Wall, Double Chamber Autoclave. The Lid, Ring, Inner Chamber, Middle Chamber and Outer Wall are made of Stainless Steel. The instrument is absolutely leak proof. Equipped with Pressure Gauge, Safety Valve, Double Safety Valve, Steam Release Valve, Rubber Gasket, Mild Steel Legs for Autoclave. The autoclave can hold the in between 5psi to 20 psi

Size (Inch)	Capacity	
12" x 22"	40ltr	Electrical
14" x 25"	60ltr	Electrical
16" x 24"	75ltr	Electrical
18" x 24"	95ltr	Electrical
22" x 30"	180ltr	Electrical

TRIPLE WALL AUTOCLAVE

Triple Wall Vertical Hi-Pressure Radial Locking – with steam jacket

Size/Capacity: 40ltr -180ltr

Triple Wall, Double Chamber Autoclave. The Lid, Ring, Inner Chamber, Middle Chamber and Outer Wall made of Stainless Steel. Middle Chamber works as steam Stock Jacket. The instrument is absolutely leak proof. Equipped with Pressure Gauge, Safety Valve, Double Safety Valve, Steam Release Valve, Rubber Gasket, Mild Steel Legs for Autoclave. The autoclave can hold the in between 5psi to 20 psi.

Additional Controls like Pressure Control Switch, Low Water cut off, Digital Timer, Digital Temperature, Alarm / Buzzer is provide with this unit

Size (Inch)	Capacity	
12" x 22"	40ltr	Electrical
14" x 25"	60ltr	Electrical
16" x 24"	75ltr	Electrical
18" x 24"	95ltr	Electrical
22" x 30"	180ltr	Electrical



TRIPLE WALL AUTOCLAVE

JULLUNDUR ENTERPRISES

VERTICAL AUTOCLAVES



TRIPLE WALL AUTOCLAVE

Tripe Wall Vertical Hi - Pressure Radial Locking - with steam jacket

Size/Capacity: 40ltr -180ltr

Triple Wall Double Chamber Autoclave. The Inner Chamber , Middle Chamber and Outer Wall made of Stainless Steel, Ring Made of Stainless Steel/ Mild Steel. The lid is made of Stainless steel tightened by radial arms through a steering wheel made of Chrome plated Mild Steel. The instrument is absolutely leak proof. Middle Chamber works as steam Stock Jacket. Equipped with Pressure Gauze, Safety Valve, Double Safety Valve, Steam Release Valve, Rubber Gasket, Inner Container, S.S Bucket, and Mild Steel Legs for Autoclave. The Autoclave can hold the in between 5psi to 20 psi.

Additional Controls like Pressure Control Switch, Low Water cut off, Digital Timer, Digital Temperature, Alarm / Buzzer is provide with this unit.

Size (Inch)	Capacity	
12" x 22"	40ltr	Electrical
16" x 24"	75ltr	Electrical
22" x 30"	180ltr	Electrical

JULLUNDUR ENTERPRISES

HORIZONTAL AUTOCLAVES



Cylindrical Horizontal Autoclave Double Wall

The sterilizer is based on the principle that microbiological action of saturated steam at elevated temperature is rapid and through. All models work on principle of downward displacement of air which is most economical method of obtaining sterilization.

Size/Capacity: 75ltr - 300ltr

Construction:-

Double Walled Inner chamber S.S304 16g and outer cover made of S.S 304, Lid Made of S.S. Radial Locking made of Mild Steel Chrome Plated, Ring M.S Painted. Autoclave mounted on tubular steel frame with ground leveling screwed flages. Boiler 304 S.S, All parts of S.S 304

Pressure Control:-

The pressure control device, Digital Timer, Digital Temperature, Low water cut off Devise and Buzzer on completion of cycle is incorporated in electrically operated sterilizer. It economies on power consumption and reduces the frequent opening steam release value and prevents the release of steam in room.

Operating Temp & Pressure

Sterilizing Temp : 120° C
Sterilizing pressure : 1.2 to 1.5 Kg/cm2 (15 psi- 20 psi)

DOUBLE WALL AUTOCLAVE

Size (Inch)	Capacity
16" x 24"	75ltr
16" x 44"	140ltr
20" x 36"	185ltr
20" x 48"	250ltr
22" x 48"	300ltr



Cylindrical Horizontal Autoclave Triple Wall

The sterilizer is based on the principle that microbiological action of saturated steam at elevated temperature is rapid and through. All models work on principle of downward displacement of air which is most economical method of obtaining sterilization.

Construction:-

Triple Walled with Steam jacket. Inner chamber and steam jacket made of S.S With leak proof argon welding. Lid Made of S.S. Autoclave mounted on tubular steel frame with ground leveling screwed flages.

Pressure Control:-

The pressure control device is incorporated in all electrically operated sterilizer. It economies on power consumption and reduces the frequent opening steam release value and prevents the release of steam in room.

Operating Temp. & Pressure

Sterilizing Temp. : 120° C
Sterilizing pressure : 1.2 to 1.5 Kg/cm2 (15 psi- 20 psi)
Power : Suitable to operate on 440V, 3ph, 50 Hz, Ac Supply

TRIPLE WALL AUTOCLAVE

Size (Inch)	Capacity
16" x 24"	75ltr
16" x 44"	140ltr
20" x 36"	185ltr
20" x 48"	250ltr
22" x 48"	300ltr

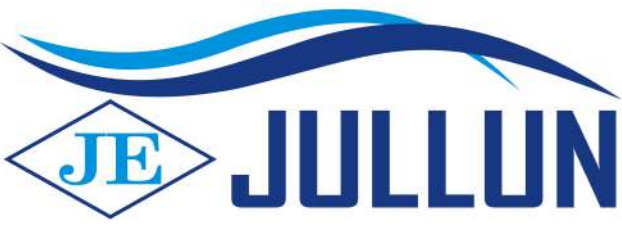

JULLUNDUR ENTERPRISES



HOSPITAL HOLLOWARES



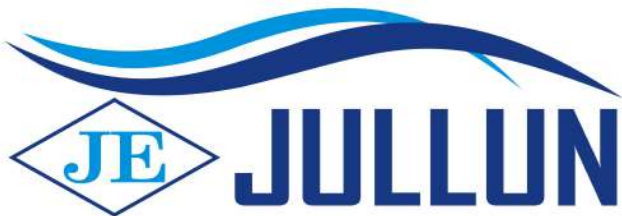

JULLUNDUR ENTERPRISES



HOSPITAL HOLLOWARES

Dressing Drums Seamless (Joint less)

Model	Size D x H (Inch)	Size D x H (Inch)
	6" x 4"	6" x 6"
	9" x 5"	9" x 9"
	11" x 5"	11" x 9"
	14" x 5"	14" x 9"
	15" x 12"	

DRESSING DRUM SEAMLESS S.S.

Dressing Drums Jointed

Model	Size D x H (Inch)	Size D x H (Inch)
	6" x 4"	6" x 6"
	8" x 5"	8" x 8"
	9" x 5"	9" x 9"
	11" x 5"	11" x 9"
	11" x 18"	12" x 9"
	12" x 10"	12" x 12"
	14" x 5"	14" x 9"
	14" x 10"	14" x 11"
	14" x 12"	15" x 9"
	15" x 10"	15" x 12"
	15" x 18"	

DRESSING DRUM JOINTED S.S.

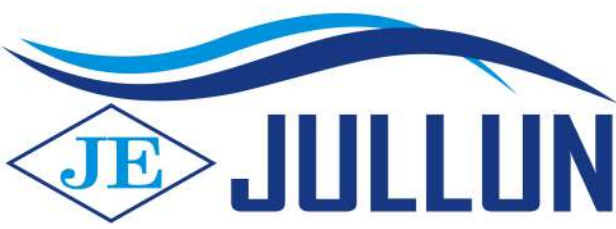

JULLUNDUR ENTERPRISES



HOSPITAL HOLLOWARES

Instrument Tray with Lid (Cover)

Size L x B (Inch)

8" x 6"

10" x 8"

11" x 9"

12" x 8" x 2 1/2"

12" x 10"

15" x 12"

18" x 12" x 3"

Size L x B (Inch)

9" x 6"

11" x 7"

12" x 8"

12" x 9"

14" x 10"

18" x 12"



INSTRUMENT TRAYS WITH COVER S.S.

Stainless Steel Kidney Tray

Size L (Inch)

6"

9"

12"

Size L (Inch)

8"

10"



KIDNEY TRAYS S.S.

Catheter Tray with Lid (Cover)

Size L x B (Inch)

8" x 3"

16" x 4"

Size L x B (Inch)

9" x 3"



CATHETER TRAY WITH COVER S.S.



JULLUNDUR ENTERPRISES



HOSPITAL HOLLOWARES

Stainless Steel Bowls

Size (Cm)	Size (Cm)
7.5 cm	10 cm
12 cm	15 cm
18 cm	20 cm

LOTION BOWLS S.S.

Stainless Steel Bowls

Size (Ml)	Size (Ml)
600 ml	1200 ml

LOTION BOWLS S.S.

Stainless Steel Hospital Basins

Size (Cm)	Size (Cm)
23 cm	26 cm
28 cm	30 cm
32 cm	35 cm
40 cm	

WASH BASINS S.S.

Gallipots without Lid (Cover)

Size D X H (mm)	Capacity	Size D X H (mm)	Capacity
65 x 30 mm	2 oz	75 x 40 mm	4 oz
85 x 46 mm	6 oz	97 x 50 mm	8 oz

GALLIPOT WITHOUT COVER S.S.

Gallipots with Lid (Cover)

Size D X H (mm)	Capacity	Size D X H (mm)	Capacity
65 x 30 mm	2 oz	75 x 40 mm	4 oz
85 x 46 mm	6 oz	97 x 50 mm	8 oz

GALLIPOT WITH COVER S.S.

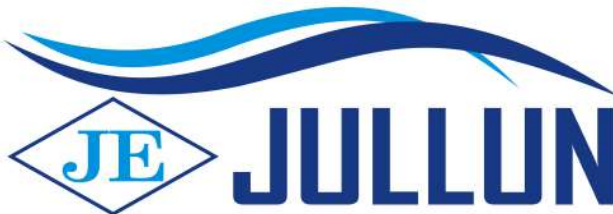

JULLUNDUR ENTERPRISES



HOSPITAL HOLLOWARES

Instrument Sterilizers Electrical

Size L x B x h (MM)

- 200 X 100 X 60mm
- 300 X 150 X 150mm
- 400 X 150 X 150mm
- 430 X 200 X 200mm
- 500 X 200 X 200mm
- 600 X 300 X 150mm



INSTRUMENTS STERILIZER ELECTRIC S.S.

Size L x B x (MM)

- 200 x 127 x 75mm
- 350 x 150 x 150mm
- 400 x 200 x 150mm
- 450 x 200 x 200mm
- 600 x 200 x 200mm
- 600 x 300 x 300mm

Instrument Sterilizers Electrical Jointed with Tray Lifting Thermostat

Size L x B x h (MM)

- 300 X 150 X 150mm
- 400 X 150 X 150mm
- 430 X 200 X 200mm
- 500 X 200 X 200mm
- 600 X 300 X 150mm



Size L x B x (MM)

- 350 x 150 x 150mm
- 400 x 200 x 150mm
- 450 x 200 x 200mm
- 600 x 200 x 200mm
- 600 x 300 x 300mm

Instrument Sterilizers Non- Electrical Jointed

Size L x B x h (MM)

- 300 X 150 X 150mm
- 400 X 150 X 150mm
- 430 X 200 X 200mm
- 500 X 200 X 200mm
- 600 X 300 X 150mm



Size L x B x (MM)

- 350 x 150 x 150mm
- 400 x 200 x 150mm
- 450 x 200 x 200mm
- 600 x 200 x 200mm
- 600 x 300 x 300mm

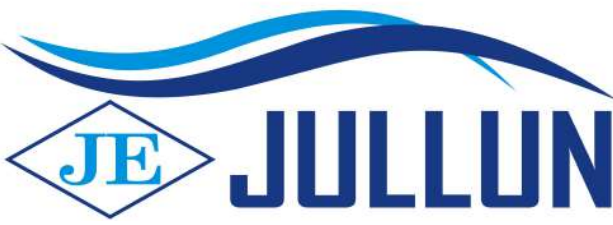

JULLUNDUR ENTERPRISES



HOSPITAL HOLLOWARES

Bowls & Utensils Sterilizers



Bowls & Utensils Sterilizers Stainless Steel

Complete with Paddle lifting arrangement Stand fitted

Size (Inch)

20" X16" X16"

20" X 20" X 20"

24" X 20" X20"

24" X 24" X20"

Instrument Sterilizers Electrical with tray lifting Joint less /Seamless

Size L x B x h (MM)

300 X 150 X 150 mm

430 X 200 X 200 mm

500 X 200 X 200mm



INSTRUMENTS STERILIZER ELECTRIC WITH TRAY LIFTING ARRANGEMENT S.S.

Instrument Sterilizers Electrical Joint less /Seamless with Tray Lifting and Thermostat

Size L x B x H (MM)

300 X 150 X 150 mm

430 X 200 X 200 mm

500 X 200 X 200 mm



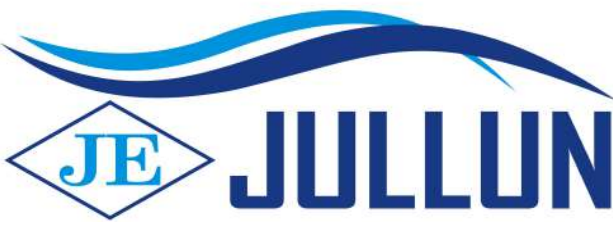

JULLUNDUR ENTERPRISES



HOSPITAL HOLLOWARES

Enema Can Stainless Steel

Capacity

1ltr

1.5ltr

2ltr



ENEMACAN S.S. (1 LTR., 1.5 LTR., 2 LTR.)

Thermometer Jar Stainless Steel



THERMOMETER JAR S.S.

Measuring Jug

Capacity

0.5ltr

1ltr

1.5ltr

2ltr



MEASURING JAR S.S.

Forceps Jar Stainless Steel

Size D x H (Inch)

2 x 5

2 x 6

2 x 7

2 x 8

2 x 9



FORCEP JAR S.S.

Dressing Jar Stainless Steel

Capacity

0.5ltr

1ltr

2ltr



DRESSING JAR S.S.

Sputum Mug

Capacity

Small

Medium

Large



Waste Bin (Push can)



DUSTBIN PUSH TYPE S.S.

Waste Bin (Paddle Type)

Litre

5ltr

7.5ltr

12ltr

20ltr

35ltr



DUST BIN PEDESTAL S.S WITH PLASTIC BUCKET

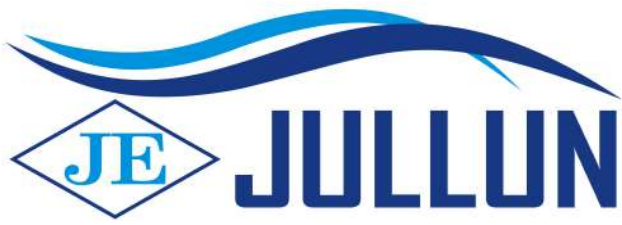

JULLUNDUR ENTERPRISES



HOSPITAL HOLLOWARES

Urinal (Urine Pots) Stainless Steel

Urinal Male



Urinal Fe- Male

Urinal Fe- Male Seamless

Bed Pans Stainless Steel Male and Female with and without Lid (Cover)

Bed Pan Female with Lid

Bed Pan Female without Lid

Bed Pan Male without Lid



BED PAN FEMALE WITH COVER S.S.



BED PAN MALE WITH COVER S.S.

Bed Pans Seamless Stainless Steel Female with and without Lid (Cover)

Model

Bed Pan Seamless Female with Lid

Bed Pan Seamless Female without Lid



BED PAN FEMALE WITH COVER SEAMLESS WELD S.S.

Bed Pans Stainless Steel Round with and without Lid (Cover)

Model

Bed Pan Seamless Round with Lid

Bed Pan Seamless Round without Lid





India's Biggest Manufacturers of :
ANESTHESIA MACHINES
SUCTION MACHINES
OXYGEN THERAPY EQUIPMENT



JULLUNDUR ENTERPRISES

(AN ISO 9001 : 2008 CERTIFIED COMPANY)

www.jemediguard.com

PORTABLE ANAESTHESIA MACHINE



- Construction: trolley made by tubular rigid steel section electrostatically powder coated or stainless steel
- Suitable drawer
- Unitised rota meter block for oxygen & nitrous oxide with fine adjustment controls & colour coated knob and luminous back plate.
- Oxygen flow meter calibrated from 100cc/min to 10 Itrs. / Minute & Nitrous oxide flow meter from 200cc/min to 12 liters/min down Stream receipt of oxygen
- One gold man type vaporizer for halothene
- Non return cum emergency oxygen unit with blow off valve in circuit ensures that pressure does not build-up beyond 200cm. water column & minimize risk of back flow of gases.
- Two pre set regulators (forged quality) one each for O₂ & N₂O with high pressure tubing non inter changeable for connection with flow meter inlet
- One Maggill's & bain circuit

Dimension

Height	Depth	Width
40 cm	18 cm	30cm
Weight App. 10kg		



ANAESTHESIA MACHINE 02



- Construction : Trolley made by tubular rigid steel section electrostatically powder coated or stainless steel
- Suitable drawer for keeping anaesthesia kit
- Extended platform at rear for one 10 ltrs. (Water capacity) cylinder
- Small roller bearings, antistatic castors, for easy mobility
- Top tray provided at eye level for keeping monitoring equipments
- Hook for breathing circuit
- Wipe clean stainless steel top
- Unitised rota meter block for oxygen & nitrous oxide with fine adjustment controls & colour coated knob and luminous back plate. Oxygen flow meter calibrated from 100cc/min to 10 ltrs. Minute & Nitrous oxide flow meter from 200cc/min to 12 liters/min down stream receipt of oxygen
- One gold man type vaporizer for halothane
- Non return cum emergency oxygen unit with blow off valve in circuit ensures that pressure does not build-up beyond 200cm. water column & minimize risk of back flow of gases.
- Cylinder yokes: Pin indexed yokes one each of oxygen & nitrous oxide 50mm diameter, colour coated gauges fitted at convenient angle for better visibility & clarity
- High efficiency regulators for reliability one each for O₂ & N₂O self sealing valve attachment for additional oxygen source from central gas pipe line
- One Maggill's or Bain circuit

Safety Features :

- Emergency Oxygen Flush
- Nitrous Oxide Shut Off in the Event of O₂ Failure

Dimension

- Height : 152cm
- Depth : 43cm
- Width : 55cm
- Weight App. : 35kg

ANAESTHESIA MACHINE 03

- Construction: Trolley made by tubular rigid steel section electrostatically powder coated or stainless steel
- Suitable drawer for keeping anaesthesia kit/accessories
- Extended platform at rear for two 10 Ltrs. (Water cap.) cylinders
- Small roller bearings, antistatic castors, for easy mobility and brakes
- Top tray provided at eye level for keeping monitoring equipments
- Hook for breathing circuit
- Wipe clean stainless steel top
- Unitised rota meter block for oxygen & nitrous oxide with fine adjustment controls & colour coated knob and luminous back plate. Oxygen flow meter calibrated from 100cc/min to 10 ltrs. / Minute & Nitrous oxide flow meter from 200cc/min to 12 liters/min down Stream receipt of oxygen
- One gold man type vaporizer for halothene, provision to mount two vaporizers at a time
- Non return cum blow off valve in circuit ensures that pressure does not build-up beyond 200cm. water column & minimises risk of back flow of gases.
- 60 psl outlet for driving ventilator
- Emergency Oxygen flush valve At table level to give 35-60 ltrs./min for emergencies
- Cylinder yokes: Pin indexed yokes two each of oxygen & nitrous oxide
- 50mm diameter, colour coded gauges fitted at convenient angle for better visibility & clarity
- High efficiency regulators for reliability two each for O₂ & N₂o
- One Maggill's or Bain circuit



Safety Features

- Emergency oxygen flush
- Alarm to provide audible indication of O₂ supply pressure failure
- Nitrous oxide shut off in the event of O₂ failure

Dimension

Height	Depth	Width
152cm	60cm	65cm
Weight App.	45kg	

ANAESTHESIA MACHINE 04

- Construction: Trolley made by tubular rigid steel section electrostatically powder coated or stainless steel
- Capacious drawer for keeping anaesthesia kit / accessories
- Extended platform at rear for two 10 ltrs. (Water Cap.) cylinders
- Large roller bearings, antistatic castors, for easy mobility and brakes
- Top tray provided at eye level for keeping monitoring equipments
- Hook for breathing circuit
- Wipe clean stainless steel top
- Convenient mounting of circle absorber (Optional)
- Unitised rota meter block for oxygen & nitrous oxide with fine adjustment controls & colour coated knob and luminous back plate. Oxygen flow meter calibrated from 100cc/min to 10 ltrs/min & Nitrous oxide flow meter from 200cc/min to 12-liters/min down Stream receipt of oxygen (air 0 to 12 ITRS optional)
- One gold man type vaporizer for halothene, provision to mount three vaporizer at a time
- Non return cum blow off valve in circuit ensures that pressure does not build-up beyond 200cm. Water column & minimises risk of back flow of gases.
- 60 psl outlet for driving ventilator
- Change over system open circuit or close circuit
- Emergency Oxygen flush valve At table level to give 35-60 ltrs/min for emergencies
- Cylinder yokes: Pin indexed yokes two each of oxygen & nitrous oxide
- 63 mm diameter, colour coded gauges fitted at convenient angle for better visibility & clarity
- High efficiency regulators for reliability two each for O₂ & N₂O
- One Maggill's or Bain circuit



Safety Features

- Emergency oxygen flush
- Alarm to provide audible indication of O₂ supply pressure failure
- Nitrous oxide shut off in the event of O₂ failure

Dimension

Height	Depth	Width
152cm	65cm	80cm
Weight App. 55kg		

ANAESTHESIA MACHINE 05

Construction: Steel electrostatically powder coated or stainless steel

- Capacious drawer for keeping anaesthesia kit/accessories
- Extended platform at rear for two 10 ltrs. (Water Cap.) cylinders
- Large roller bearings, antistatic castors, for easy mobility and brakes
- Top tray provided at eye level for keeping monitoring equipments
- Hook for breathing circuit
- Wipe clean stainless steel top
- Provision to fit ventilator
- Convenient mounting of circle absorber (Opt.)
- Emergency drug tray fitted at convenient place
- Unitised rota meter block for oxygen & nitrous oxide with fine adjustment controls & colour coated knob and luminous back plate. Oxygen flow meter calibrated from 100cc/min to 10 ltrs./ Minute & Nitrous oxide flow meter from 200cc/min to 12 liters/min down Stream receipt of oxygen & (air 0 to 12 ltrs. optional)
- One plenum type vaporizer for ether (optional) & one gold man type vaporizer for halothane, provision to mount three vaporizer at a time
- Non return cum blow off valve in circuit ensures that pressure does not huld-up beyond 200cm. Water column & minimises risk of back flow of gases
- 60 psl outlet for driving ventilator
- Change over system open circuit or close circuit
- Emergency Oxygen flush valve at table level to give 35-60 ltrs/min for emergencies
- Cylinder yokes: Pin indexed yokes two each of oxygen & nitrous oxide
- 63 mm diameter, colour coded gauges fitted at convenient angle for better visibility & clarity, one gauge for O₂ & one gauge for N₂O shown the line pressure
- High efficiency regulators for reliability two each for O₂ & N₂O
- One Maggill's or Bain circuit
- One B.P Apparatus.



Safety Features

- Hypoxic guard
- Emergency oxygen flush
- Alarm to provide audible indication of O₂ supply pressure failure
- Nitrous oxide shut off in the event of O₂ failure

Dimension

Height	Depth	Width
150cm	68cm	78cm
Weight App. 60kg		

Optional Accessories



Temperature Compensated Vaporizers



Circle Absorber Model No. 77



Anaesthetic Ventilator



Circle Absorber Model No. 55



Bulk conversion Kit for O2 & N2O

Mfg. of : All Type of oxygen flow Meters,
Rotameters, All type of Gas regulator's
& Other Accessories



Laryngoscopes



Nitrous Oxide Regulator

Oxygen Regulator



Corrugated Tube

Face Mask



Silicon Resuscitators



Model No. 55

Max Regulaor

Fine Adjustment
Valve with Rotameter
& humidifier Bottle



BPC flow Meter
with Humidifier



Oxygen Regulator with
BPC Flowmeter and
humidifier Bottle
Model No. 66



Fine Adjustment
Valve with Rotameter
& humidifier Bottle
Model No. 77



Spanner



Two Stage Regulator



Ward Vacuum Unit with Regulator



Humidifier Bottle
(S. Type Hook)

Oxygen Therapy Equipment



JULLUNDUR ENTERPRISES

▲ OXYGEN PRESET REGULATOR WITH PIN-IN-DEX VALVE

- Single Stage regulator
- Safety gauge 3000 kg/cm² for inlet pressure preset located near at 4.21 kg/cm² 0.00 lbs/sq inch.
- Built in Safety Valve
- Forged brass body bright chrome plated



JULLUNDUR ENTERPRISES

▲ TWO STAGE DOUBLE GAUGE REGULATOR

- Forged brass body. Chrome plated brass body built in safety valve.
- Pressure gauge 3000 Kg/cm² for inlet Pressure.
- Pressure gauge 300 Kg/cm² for outlet Pressure.

▲ FINE ADJUSTMENT VALVE WITH ROTAMETRE AND HUMIDIFIER BOTTLE

- Chrome plated brass body
- Powder coated metal knob
- Pressure gauge 3000 Kg/cm²
- Humidifier bottle 200 TSI (Poly carbonate)
- Flowrate calibrated in 1 Liter (total) per min between 1 to 15 Litre/min



**OXYGEN PIPE LINE
FLOWMETRE WITH
HUMIDIFIER BOTTLE**

Chrome plated brass body. Unbreakable
humidifier bottle of 200 ml
(Also available in polycarbonate body)



**BACK PRESSURE COMPENSATED FLOWMETRE
COMPLETE WITH HUMIDIFIER & REGULATOR**



HUMIDIFIER FOR BOTTLE

Powder coated chrome plated brass cap
Polycarbonate unbreakable bottle of 200 ml



**OXYGEN / NITROUS
OXIDE CYLINDER
CLAMP (Yoke Adaptor)**

Clamp for A type cylinder to
connect to B type cylinder

GAS SPANNERS

- 1/2" Key for A type Cylinder
- 3/8" Key for B type Cylinder

**FINE ADJUSTMENT VALVE
WITH FLOW METRE**

- Chrome plated brass body
- Pressure gauge 3000 Kg/cm²
- Powder coated metal knob
- Flow rate calibrated in 1 Liter
installments between 1 to 10
Litres/hr



**FINE ADJUSTMENT VALVE
WITH ROTAMETRE**

- Chrome plated brass body. Pressure
gauge 3000 Kg/cm²
- Powder coated metal knob
- The cone valve prevents the gas
backflow
- The flow rate in 1 Liter installments
between 1 to 10 Litres/hr



- (A) **DELUXE OXYGEN FINE ADJUSTMENT
VALVE WITH ROTAMETRE**
(B) **DELUXE OXYGEN FINE ADJUSTMENT
VALVE WITH FLOWMETRE & HUMIDIFIER
BOTTLE**

Light weight brass body (Chrome plated) Unbreakable
polycarbonate (also safety pressure gauge 3000 kg/cm²) Flow
rate calibrated in 1 Liter installments between 1 and 10
Litres/hr. Large size brass body powder coated knob



HIGH VACUUM SUCTION APPARATUS

Features

- ❖ Cabinet : Made by mild steel with electrostatically powder coated mounted on 63 mm diameter on (4) Rubber castors
Stainless steel top with tray for Keeping instruments.
- ❖ Reuseable filter
- ❖ JARS : 2 x 2 LTRS. glass JARS fitted with synthetic Rubber lids with over flow safety device
- ❖ Vacuum gauge : 76 mm Diameter graduated in mm Hg
- ❖ Vacuum -700 mm Hg \pm 10% control by knob.
- ❖ Suction capacity : 35 LTRS/min
- ❖ Power : 230V- 50 Hz
- ❖ Foot switch socket : Provided socket in side use for foot switch.

Dimension

Height	Depth	Width
86cm	33cm	48cm
Weight :- 29 kg Approx.		



Deluxe Model

Mobile suction unit

- ❖ cabinet made by mild steel, electrostatically powder coated
- ❖ 50 mm diameter Rubber castors.
- ❖ 2 glass Jar of 1.5 LTRs with over flow safety device.
- ❖ Oil immersed motorized noise less vacuum pump.
- ❖ Stainless steel top.
- ❖ Vacuum create- 700 mm Hg \pm 10% control by knob.
- ❖ 63 mm diameter vacuum gaug graduated in mm Hg
- ❖ Reusable filter.
- ❖ Foot switch socket for use foot switch.
- ❖ Power : 230V- 50 Hz

Dimension

Height	Depth	Width
75cm	30cm	35cm
Weight :- 18kg Approx		

DELUXE ELECTRIC CUM FOOT SUCTION APPARATUS

Suction machine electric cum foot model with two separate system electric & pedal

- ❖ 2 glass suction jars each of 1.5 LTRS. capacity fitted with synthetic Rubber lids & over flow safety device
- ❖ Oil immersed motorized noise less vacuum pump.
- ❖ Cabinet made by mild steel with powder coated with two vacuum gauges mounted on 4 rubber castors & Stainless steel top
- ❖ Reuseable filter
- ❖ Electric Vacuum : 700 mm Hg \pm 10% control by knob
- ❖ Manual Vacuum : 600 mm Hg \pm 10% creating Vacuum instantly.
- ❖ Power : 230V- 50 Hz

Dimension

Height	Depth	Width
75cm	45cm	41cm
Weight :- 21 kg Approx.		



DUAL POWER SUCTION APPARATUS

TECHNICAL SPECIFICATION

- ❖ VACUUM :- electric-760 mmhg & manual-600 mm hg
- ❖ BODY :- m.s. spot welded with electrostatically powder coated
- ❖ VACUUM GAUGE :- two gauges of 62 cms, 0-760 mm hg calibrated
- ❖ JARS :- TWO Autoclavable pc jars each for 2 ltrs. capacity with over flow safety device
- ❖ POWER :- 230V,50HZ,200watts

SPECIAL FEATURES

- ❖ Superior quality suction Manual pump for instant vacuum
- ❖ Powder coated cabinet with stainless steel top plate for easy to clean & maintain
- ❖ Heavy duty antistatic castors
- ❖ Versatile for m.t.p. & other major surgical applications
- ❖ Oil rotary noiseless pump (electric) and piston pump (manual)



Dimension

Height	Depth	Width
85cm	40cm	45cm
Weight :- 28kg Approx.		

PORTABLE SLOW SUCTION

- ❖ Cabinet made by mild steel with electrostatically powder coated mounted on rubber Pads.
- ❖ Two poly carbonate jars each capacity 600 ml. (also available in 1000 ml jars with over flow safety device).
- ❖ Vacuum gauge 50 mm diameter graduated in mm Hg.
- ❖ Vacuum create -700 mm Hg \pm 10%, 20 LTR / min
- ❖ Oil immersed motorized noiseless pump
- ❖ Reuseable filter
- ❖ Power : 230V- 50 Hz 110V VOLTS on Rtequest

Dimension

Height	Depth	Width
50cm	38cm	34cm
Weight :- 16kg Approx.		

MINIATURE PORTABLE SLOW SUCTION

Special feature :

- ❖ Cabinet made by ABS plastic & mild steel pump : oil free diaphragm pump not to be lubricated.
- ❖ Suction Capacity : 15 LTRS/min Vacuum -600 mm Hg \pm 10% control by knob
- ❖ JARS : 2 JAR of 600 ml (also available in 1000 ml. Jar with over flow safety device)
- ❖ Filter : Re use able filter
- ❖ Power : 230 Volt (110Volt on Request)
- ❖ Safety : AC fuse
- ❖ Gauge : 50 mm. gauge calibrated mm Hg.

Dimension

Height	Depth	Width
46cm	27cm	36cm
Weight :- 5 kg Approx.		



UNIVERSAL VAC

AC DC Battery operated Suction

(for Ambulance, Hospital, home Care, travel camp etc.)

Features

- ❖ Cabinet made by ABS Plastic & Mild steel with electrostatically powder coated.
- ❖ Oil free diaphragm pump not to be lubricated
- ❖ -550 mm hg \pm 10% vacuum control by knob, suction capacity 15Lt min
- ❖ Battery Backup 1 hours 25 minutes on full charge
- ❖ Provided with AC Adaptor and cigarette lighter socket cable for use in Ambulance/Car
- ❖ One Jar of 1000 ml. with over flow safety device
- ❖ 50 mm gauge calibrated in mm Hg
- ❖ Power 220V, (110 Volt on Request)



Dimension

Height	Depth	Width
24cm	26cm	44cm
Weight :- 7.5 kg Approx.		

MICRO VAC DC SUCTION APPARATUS

For use in Ambulance

- ❖ Mild steel cabinet
- ❖ 50 mm vacuum gauge graduated in mm Hg
- ❖ Oil free diaphragm pump not to be lubricated
- ❖ -550 mm Hg \pm 10% vacuum Capacity 15 LTRS/min
- ❖ Provided cigarette lighter socket cable for use in Ambulance
- ❖ One JAR of 600 ml (also available in 1000 ml with over flow device)

Dimension

Height	Depth	Width
33cm	11cm	29cm
Weight :- 3.5 kg Approx.		



FOOT SUCTION UNIT

Portable twin JAR each 600 ml. PC Jar, superior piston pump for creating vacuum -600 mm Hg. Instantly, Base made from mild steel sheet with electrostatically powder coated

Vacuum guage 50 mm diameter Calibrated in mm Hg. (also available in stainless Base).

Dimension

Height	Depth	Width
30cm	25cm	33cm
Weight :- 4.500kg Approx.		



WARD VACUUM UNIT

(Use In. Pipe Line Fitting)

- ❖ Vacuum guage : 50 mm diameter, Graduated in mm Hg
- ❖ Regulator : Made by Aluminum & plastic ABS
- ❖ Vacuum : control by Regulator knob
- ❖ JAR : Poly carbonate 2000 ml. (Available in 600 ml. jar)





**India's Biggest Manufacturers of :
ANAESTHESIA EQUIPMENTS**



JULLUNDUR ENTERPRISES

(AN ISO 9001 : 2008 CERTIFIED COMPANY)

www.jemediguard.com

SILICONE RESUSCITATORS

Resuscitator Adult With Pop-off Valve

- Silicone Adult 1600 ml Resuscitator Set with 60CM HO Pop-off Valve
- Silicone Mask Size: 4 No.
- 2600 ml Oxygen Reservoir Bag
- Disposable Oxygen Tubing 2 Mtr.
- Reusable & Latex Free

Resuscitator Adult With Pop-off Valve

- Silicone Adult 1600 ml Resuscitator Set with 60CM HO Pop-off Valve
- Silicone Mask Size: 4 No.
- 2600 ml Oxygen Reservoir Bag
- Disposable Oxygen Tubing 2 Mtr.
- Reusable & Latex Free

Resuscitator Adult With Pop-off Valve

- Silicone Adult 1600 ml Resuscitator Set with 60CM HO Pop-off Valve
- Silicone Mask Size: 4 No.
- 2600 ml Oxygen Reservoir Bag
- Disposable Oxygen Tubing 2 Mtr.
- Reusable & Latex Free

Resuscitator Adult With Pop-off Valve

- Silicone Child 500 ml Resuscitator Set with 40CM HO Pop-off Valve
- Silicone Mask Size: 1 No.
- 2600 ml Oxygen Reservoir Bag
- Disposable Oxygen Tubing 2 Mtr.
- Reusable & Latex Free

SILICONE RESUSCITATORS



Resuscitator Child With Pop-off Valve

- Silicone Child 500 ml Resuscitator Set with 40CM HO Pop-off Valve
- Silicone Mask Size: 1 No.
- 2600 ml Oxygen Reservoir Bag
- Disposable Oxygen Tubing 2 Mtr.
- Reusable & Latex Free

Resuscitator Child With Pop-off Valve

- Silicone Child 500 ml Resuscitator Set with 40CM HO Pop-off Valve
- Silicone Mask Size: 1 No.
- 2600 ml Oxygen Reservoir Bag
- Disposable Oxygen Tubing 2 Mtr.
- Reusable & Latex Free

Resuscitator Infant With Pop-off Valve

- Silicone Infant 250 ml Resuscitator Set with 40CM HO Pop-off Valve
- Silicone Mask Size: 0 No.
- 600 ml Oxygen Reservoir Bag
- Disposable Oxygen Tubing 2 Mtr.
- Reusable & Latex Free

Resuscitator Infant With Pop-off Valve

- Silicone Infant 250 ml Resuscitator Set with 40CM HO Pop-off Valve
- Silicone Mask Size: 0 No.
- 600 ml Oxygen Reservoir Bag
- Disposable Oxygen Tubing 2 Mtr.
- Reusable & Latex Free

SILICONE RESUSCITATORS

Resuscitator Infant With Pop-off Valve



- Silicone Infant 250 ml Resuscitator Set with 40CM H2OPop-off Valve
- Silicone Mask Size: 0 No.
- 600 ml Oxygen Reservoir Bag
- Disposable Oxygen Tubing 2 Mtr.
- Reusable & Latex Free

Resuscitator Adult Without Pop-off Valve



- Silicone Adult 1600 ml Resuscitator Set without Pop-off
- Silicone Mask Size: 4 No.
- 2600 ml Oxygen Reservoir Bag
- Disposable Oxygen Tubing 2 Mtr.
- Reusable & Latex Free

Resuscitator Adult With Pop-off Valve



- (Disposable)
- Disposable Adult 1600 ml Resuscitator Set with 60CM H2OPop-off Valve
 - Mask Size: 4 No.
 - 2600 ml Oxygen Reservoir Bag
 - Disposable Oxygen Tubing 2 Mtr.
 - Single Use & Latex Free

Resuscitator Child With Pop-off Valve



- (Disposable)
- Disposable Child 500 ml Resuscitator Set with 40CM H2OPop-off Valve
 - Mask Size: 1 No.
 - 2600 ml Oxygen Reservoir Bag
 - Disposable Oxygen Tubing 2 Mtr.
 - Single Use & Latex Free

Resuscitator Infant With Pop-off Valve



- (Disposable)
- Disposable Infant 250 ml Resuscitator Set with 40CM H2OPop-off Valve
 - Mask Size: 0 No.
 - 600 ml Oxygen Reservoir Bag
 - Disposable Oxygen Tubing 2 Mtr.
 - Single Use & Latex Free

RUBBER RESUSCITATORS



Black Rubber Resuscitator Adult

Autoclavable

- Double Layer Autoclavable Bellow
- Black Rubber Super Face Mask Size : 4 No.
- Autoclavable & Reusable
- Zip Pouch Packing



Black Rubber Resuscitator Child

Autoclavable

- Black Rubber Face Mask Size: 2 No.
- Autoclavable & Reusable
- Zip Pouch Packing



Black Rubber Resuscitator Adult

Non Autoclavable

- Double Layer Non Autoclavable Bellow
- Black Rubber Supper Face Mask Size: 4 No.
- Non Autoclavable & Single Use
- Zip Pouch Packing



Black Rubber Resuscitator Child

Non Autoclavable

- Black Rubber Face Mask Size: 0 No.
- Non-Autoclavable & Single Use
- Zip Pouch Packing



Black Rubber Resuscitator Regular Adult

- Non-Autoclavable & Single Use
- Zip Pouch Packing

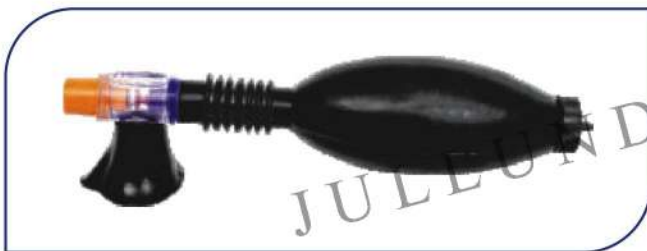

Black Rubber Resuscitator Regular Child

- Non-Autoclavable & Single Use
- Zip Pouch Packing

FACE MASK



Silicone Face Mask

- Reusable & Latex Free
- Colour Green & White

Size :
00
0
1
2
3
4
5



Black Rubber Super Face Mask

- Reusable & Latex Free

Size :
0
1
2
3
4
5



Silicone Rendell Baker Face Mask

- Reusable & Latex Free

Size : **Black Rubber** **Silicone Rubber**

0
1
2



Anaesthesia (Antistatic) Face Mask

- Reusable

Size :
0
1
2
3
4
5
6

DISPOSABLE FACE MASK



Anaesthesia Face Mask Transparent

- Single Use & Latex Free

Size :

- 0
- 1
- 2
- 3
- 4
- 5

Oxygen Mask with Reservoir Bag

- Single Use & Latex Free

Size :

- Adult
- Child

Oxygen Mask

- Single Use & Latex Free

Size :

- Adult
- Child

Nebulizer Mask

- Single Use & Latex Free

Size :

- Adult
- Child

Venturi Mask with 6 Diluters

- Single Use & Latex Free

Size :

- Adult

Oxygen Nasal Cannula

- Single Use & Latex Free
- Green Colour

Size :

- Adult
- Child
- Infant

Oxygen Recovery Kit

- Single Use & Latex Free

CPR Mask Mouth to Mouth

- Single Use & Latex Free

Size :

- Adult
- Child

Rebreathing Bag (Green)

Size :

- 0.5 Ltr.
- 1 Ltr.
- 2 Ltr.
- 3 Ltr.

Rebreathing Bag (Black)

Size :

- 0.5 Ltr.
- 1 Ltr.
- 1.5 Ltr.
- 2 Ltr.
- 2.5 Ltr.
- 3 Ltr.
- 4 Ltr.
- 5 Ltr.
- 6 Ltr.

ANAESTHESIA CIRCUITS



Bain Circuit Adult

Bain Circuit Adult Complete uses for Anaesthesia Machine with Rebreathing Bag 2 Ltr., Experty Valve & Oxygen Tubing Complete.
Optional : Face Mask

Bain Circuit Child

Bain Circuit Child Complete uses for Anaesthesia Machine with Rebreathing Bag 0.5 Ltr., Oxygen Tubing Complete.

Paediatric Jackson Rees' System

Paediatric Jackson Rees' System with Rendell Baker Mask Size: 00, 0 No. & 500 ml Rebreathing Bag Complete for Anaesthesia Machine

Anaesthesia Magill Circuit

Magill Circuit with Rebreathing Bag 2 Ltr. & Experty Valve Complete.
Optional Disposable Face Mask



ANAESTHESIA CIRCUITS

Close Circuit

Close Circuit with Expert Valve use for Anaesthesia Machine.

Optional Disposable Face Mask



Ventilator Circuit Plain Adult

- Y piece
- Elbow Connector
- Disposable & Single Use



Ventilator Circuit Plain Child/Paediatric

- Y piece
- Elbow Connector
- Disposable & Single Use



Ventilator Circuit with Double Water Trap Adult

Adult

- Y piece
- Water Trap
- Elbow Connector
- Disposable & Single Use



ANAESTHESIA CIRCUITS



Ventilator Circuit with Double Water Trap

Child / Paediatric

- Y piece
- Water Trap
- Elbow Connector
- Disposable & Single Use

Ventilator Circuit with Double Water Trap

Infant / Neonatal

- Y piece
- Water Trap
- Elbow Connector
- Disposable & Single Use

Ventilator Circuit with Double Water Trap

Adult with HME Filter, Catheter Mount & Mask

- Y piece
- Water Trap
- Elbow Connector
- HME Filter
- Catheter Mount
- Face Mask
- Disposable & Single Use

Ventilator Circuit with Double Water Trap

Adult with Catheter Mount
Reusable & Latex Free

Silicon Reusable (Autoclavable)



ANAESTHESIA CIRCUITS

Ventilator Circuit with Double Water Trap

Child / Paediatric with Catheter Mount
Reusable & Latex Free

Silicon Reusable (Autoclavable)

Ventilator Circuit with Double Water Trap

Infant / Neonatal
Reusable & Latex Free

Silicon Reusable (Autoclavable)

HME Filter (Heat Moisture Exchanger Filter)

- Luer Lock Port
- Bacterial Filtration Efficiency 99.999%
- Viral Filtration Efficiency 99.999%
- Single Use & Disposable

Bacteria Filter

- Bacterial Filtration Efficiency 99.999%
- Viral Filtration Efficiency 99.999%
- Single Use & Disposable

ANAESTHESIA CIRCUITS



Catheter Mount Swivel Connector 15/22 mm

Single Use & Latex Free



Expendable Catheter Mount Swivel

Connector 15/22 mm

Single Use & Latex Free



Silicone Catheter Mount Swivel

Connector 15/22 mm

- Silicon Reusable & Latex Free



Antistatic Corrugated Tube

Size :

42 Inch.

16 Inch.

12 Inch.



LMA & LARYNGOSCOPE

PVC Laryngeal Mask Airway

Single Use & Latex Free

Available Size: 1, 1.5, 2, 2.5, 3, 4, 5, 6



Silicone Laryngeal Mask Airway

Single Use & Latex Free

Available Size: 1, 1.5, 2, 2.5, 3, 4, 5, 6



Silicone Laryngeal Mask Airway

Reusable & Latex Free

Available Size: 1, 1.5, 2, 2.5, 3, 4, 5, 6

Reusable (Autoclavable)

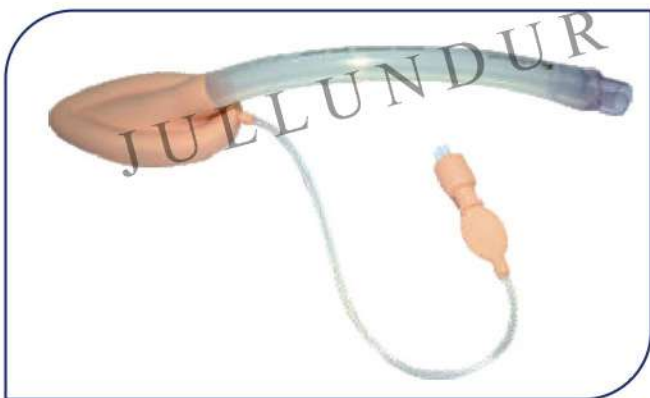

Laryngoscope Matt Finish Adult

With Macintosh Blade 1, 2, 3, 4 No. & Handle
& LED Light
White LED Light



LARYNGOSCOPE



Laryngoscope Matt Finish Child

With Miller Blade 0, 1 No. & Handle & LED Light
White LED Light



Macintosh Blades (White LED Light)

Size :

- 00 No.
- 0 No.
- 1 No.
- 2 No.
- 3 No.
- 4 No.
- 5 No.



Miller Blades (White LED Light)

Size :

- 000 No.
- 00 No.
- 0 No.
- 1 No.
- 2 No.
- 3 No.
- 4 No.



Fiber Optic Laryngoscope Adult

Fiber Optic Laryngoscope Adult with 4 Blades &
Handle with White LED Light (Box Packing)



LARYNGOSCOPE

Fiber Optic Laryngoscope Child

Fiber Optic Laryngoscope Child with 2 Blades & Handle with White LED Light (Box Packing)



Fiber Optic Macintosh Blade

Size :

- 00 No.
- 0 No.
- 1 No.
- 2 No.
- 3 No.
- 4 No.
- 5 No.



Fiber Optic Miller Blade

Size :

- 000 No.
- 00 No.
- 0 No.
- 1 No.
- 2 No.
- 3 No.
- 4 No.



Flexitip (Mc coy or Trupty) Blade

Size :

- 2 No.
- 3 No.
- 4 No.

Conventional

Fiber Optic



MANUAL SUCTION UNIT



Silicone (Ventouse) Cup Plain

With Metal Nojal

Size :

50 mm

60 mm

70 mm



Silicone (Ventouse) Cup with Release Valve

Release Valve

Size :

40 mm

50 mm

60 mm

70 mm



Vacuum Extractor Bird Type

With Three S. S. Cup



Vacuum Extractor Malmstrom Type

With Three S. S. Cup



ANAESTHESIA ACCESSORIES

Vacuum Metal Cup with Rubber Tube

Size : Rubber Tube Silicone Tube
 40 mm
 50 mm
 60 mm



Guedel Airways

Size : Single Use Reusable

000 No.
 00 No.
 0 No.
 1 No.
 2 No.
 3 No.
 4 No.
 5 No.

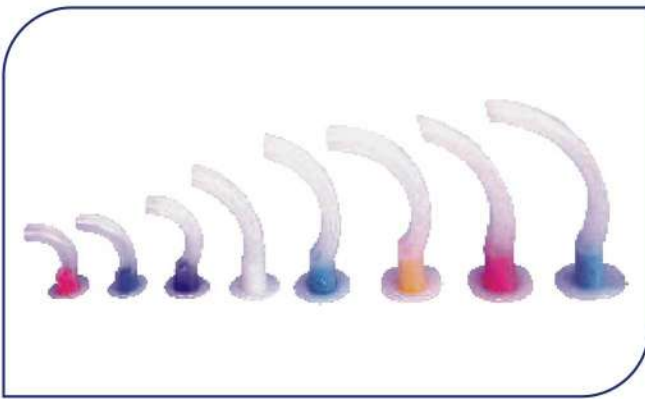

Silicone Head Harness

Color
 White
 Black
 Blue



Teeth Opener



ANAESTHESIA ACCESSORIES



Three Ball Lung Exerciser



Silicone Ring Pessary

Available Colour : White & Blue

Size :

- 50 mm
- 55 mm
- 60 mm
- 65 mm
- 70 mm
- 75 mm
- 80 mm
- 85 mm
- 90 mm
- 95 mm
- 100 mm

Stylet

Available Size: Small, Medium & Large Complete Set

Neonatal Resuscitation Kit

- Foot Suction with Silicone Tube
- Silicon Resuscitator Infant (250 ml)
- Laryngoscope Set with 0, 1 No. Miller Blades
- Airways Size: 00, 0, 1 No.
- Silicone Mask Size: 0, 1 No.
- Oxygen Tube
- Carry Bag
- Optional : Laryngeal Mask Airway & E. T. Tube



Neonatal Test Lung



Pop-off Valve for Resuscitator



Pressure :
 Adult : 60cm H₂O
 Child : 40cm H₂O
 Autoclavable & Latex Free

Non Pop-off Valve for Resuscitator



Use for Adult
 Autoclavable & Latex Free

Reservoir Bag 2600 ml with Valve



Reservoir Bag is Single Use
 Valve is Autoclavable

Reservoir Bag 600 ml with Valve



Reservoir Bag is Single Use.
 Valve is Autoclavable

Oxygen Tube 2 Mtr.



Single Use only

ANAESTHESIA CIRCUITS



Ventilator Circuit Plain Neonatal

- Y piece
- Elbow Connector
- Extra Spare tube
- Extra Spare Connectors
- Disposable & Single Use

Ventilator Circuit Single Water Trap Adult

- Y piece
- Single Water Trap
- Elbow Connector
- Disposable & Single Use

Ventilator Circuit Single Water Trap Child

- Y piece
- Single Water Trap
- Elbow Connector
- Disposable & Single Use

Ventilator Circuit Single Water Trap Neonatal

- Y piece
- Single Water Trap
- Elbow Connector
- Extra Spare tube
- Extra Spare Connectors
- Disposable & Single Use

E. T. Tube Holder

- It is used to hold the E.T. Tube
- Disposable & Single Use.

Silicone Reusable Rebreathing Bag

- Available Size: 0.5 Ltr., 1 Ltr., 2 Ltr.

Nebulizer "T" piece

- 2 Mtr. Oxygen Tube
- Nebulizer Chamber
- Corrugated Tube
- T piece
- Mouth piece

Neonatal HME Filter

- Luer Lock Port
- Bacterial Filtration Efficiency 99.999%
- Viral Filtration Efficiency 99.999%
- Single Use & Disposable

Ventilator Circuit with Pressure Monitoring Line

- Size: Adult & Child
- Available: Double Water Trap, Single Water Trap, Plain (Without Water Trap)

Specification:

- Y piece
- Elbow Connector
- Disposable & Single Use
- Double Water Trap
- Pressure Monitoring Line



**MANUFACTURER & EXPORTER
INFANT & BABY
CARE EQUIPMENT**



JULLUNDUR ENTERPRISES

LED PHOTOTHERAPY

In the new born period i.e. birth to one month, jaundice can pose a serious problem, because high level of the bilirubin, which is not water soluble, can be decomposed to a harmless metabolic which is water soluble, does not cross blood brain barrier and is rapidly excreted in the bile and urine and so does not accumulate. This has been achieved by exposing the infant to bright light (approximately 4.5 micro watts/sq cm/nm) in the range of 420-480 nm wave length by use of conventional phototherapy unit has been one of most important focus in the field of neonatology for many years. In order to remove the limitation of fluorescent and CFL tubes, SS We have utilised long lasting, durable, more efficient and cost effective LEDs with more than double the flux as against what is radiated from conventional, fluorescent and CFL, for jaundice treatment.

SPECIFICATIONS

PARAMETER

- LED 9-12 hi power LEDs(blue)(white LED optional)
- Irradiance $>42 \text{ mw/cm}^2/\text{nm}$ at 30cm
- Light source lifetime minimum 25,000hrs.
- Less than 10% change in illumination after 25,000hrs(irradiance)
- Wavelength 420-480 nm
- Variation in intensity for 6 hours $<10\%$
- Effective area 50 cm X 30 cm.

Electrical :

Input voltage 100-240 V, 50-60Hz

Dimensions :

Led box :

Front : 18" (L)x 10" (w) x3"(H) Backside : 18" x 8.5" x 3"

Height(adjustable)

Min : 1230 mm Max : 1600mm

Length -800mm Width-720mm



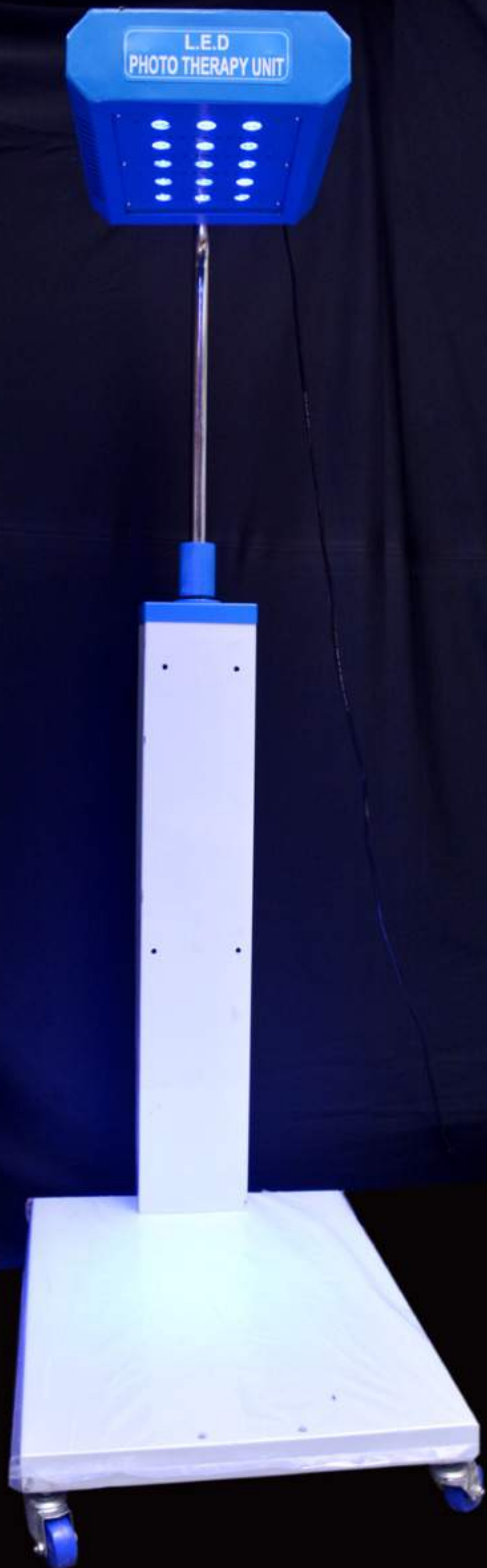

L.E.D
PHOTO THERAPY UNIT

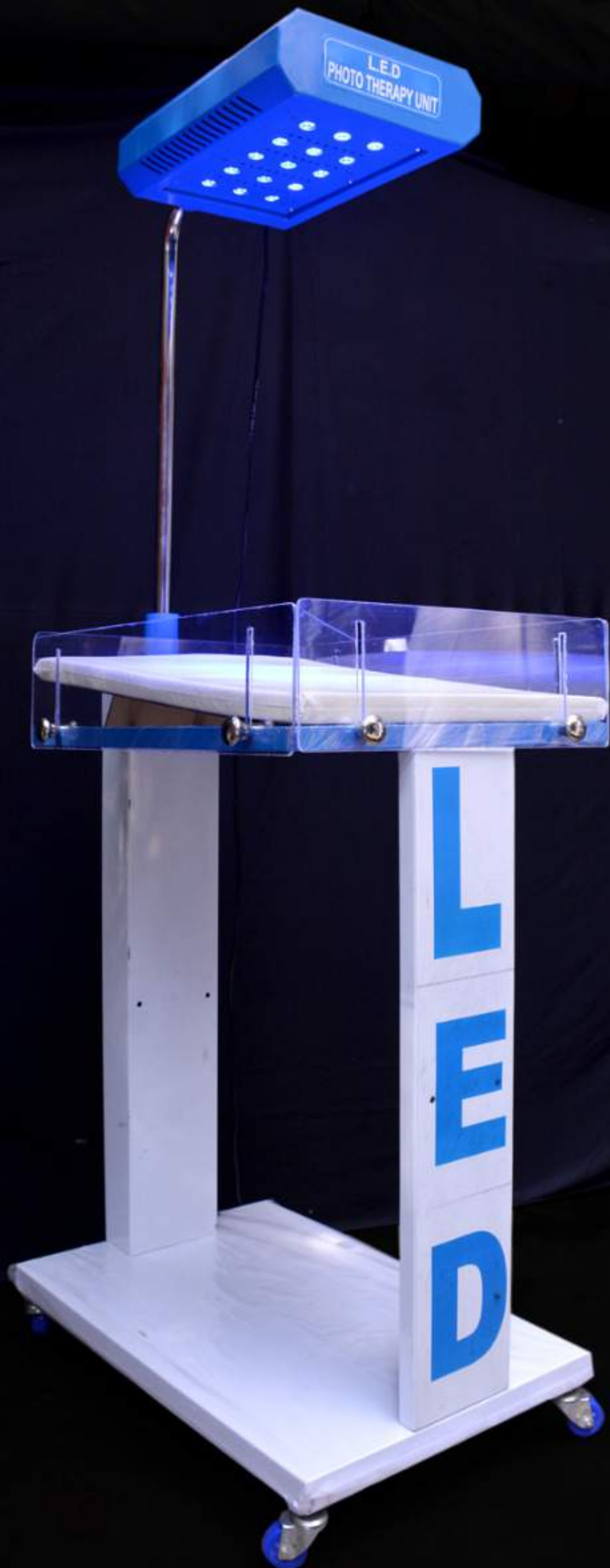

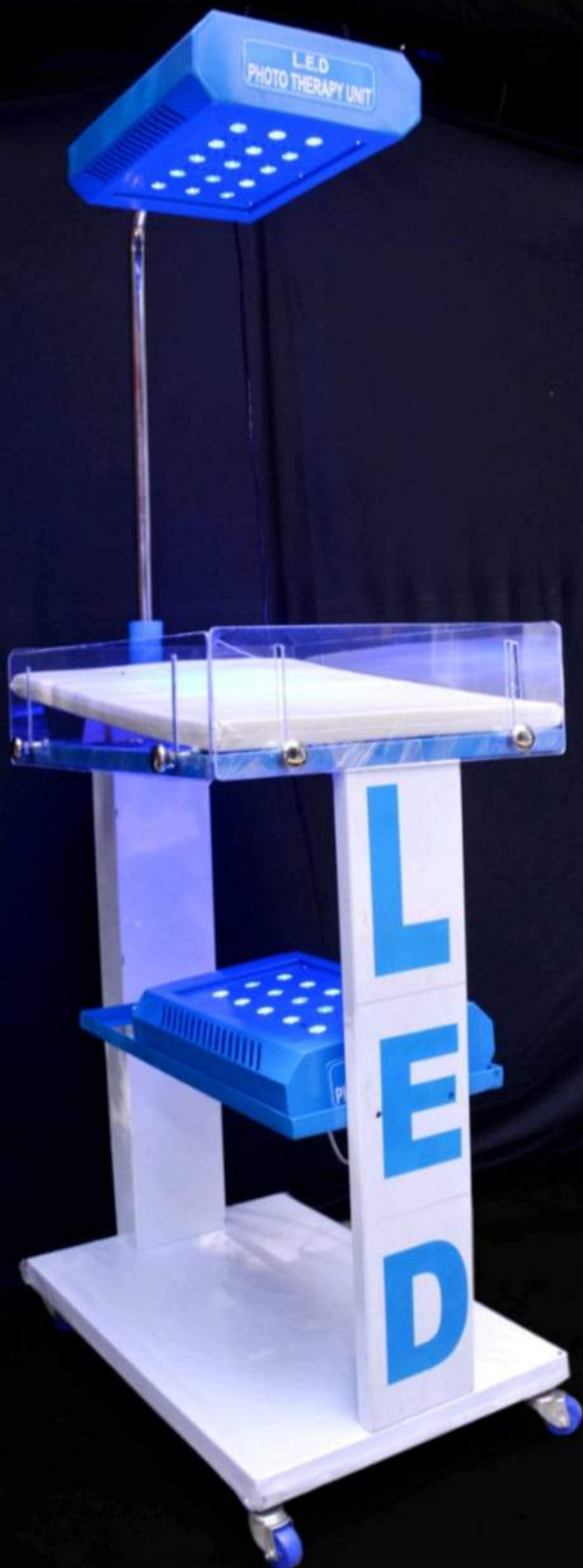

LED
PHOTO THERAPY UNIT

L

E

D





Blue
LED

0

CE



JULLUNDUR ENTERPRISES

(AN ISO 9001:2015 & 13485-2012 CERTIFIED COMPANY)



INFANT RADIANT WARMER

MODEL - 1N



INFANT RADIANT WARMER

Advance micro processor controlled system with self check on the electronic circuitry Skin / Manual control. Digital Display of Baby Temperature / Set Temperature. Manual / Servo two function control modes provide the clinician more flexibility while optimizing the thermal environment. The Spacious baby bed incorporated easily drop down sides for maximum access to the baby. The Control Panel is also the heart for a completely integrated alarm system with both audible and visual Indicators in the event of

- Probe Fail
- Skin High
- Skin Low
- Power Fail

Manual Mode

Facility of converting the warmer from servo mode to manual mode for non-stop working. The heat in the manual mode is locked at 50% to give more protection for the baby.

Heater Assembly

The Heater assembly located above the center of the support structure consists of radiant heater and reflector with inbuilt halogen examination lamp for assessment of Infant color. The heater can be swivelled to either direction.

Baby Bed

The attached spacious baby bed incorporates easy drop down glasses for maximum access to the patient.

Castors

The system is fitted with 2" high quality castors having brakes in front 2 castors. Antistatic castors can be fitted as an option for further safety in lieu of the standard castors.

Dimensions(Approx.)

Technical Specification

Height- 1920mm

Length- 890mm

Width- 860mm

Electrical Specifications

Power Supply 220V/50Hz

Heater Power 650 Watts

Fuse 5 Amp

OPTIONAL

- Undersurface LED Phototherapy

INFANT RADIANT WARMER

MODEL - 1N





JULLUNDUR ENTERPRISES

(AN ISO 9001:2015 & 13485-2012 CERTIFIED COMPANY)

CE



INFANT RADIANT WARMER

MODEL - 1NA

WITH LED PHOTOTHERAPY



CE

 **JULLUNDUR ENTERPRISES**

(AN ISO 9001:2015 & 13485-2012 CERTIFIED COMPANY)



INFANT RADIANT WARMER

MODEL - 2N

 **MEDIGUARD**[®]

INFANT RADIANT WARMER

The digital, micro processor - based controller comes with a full spectrum of features. Two function control modes provide the clinician more flexibility while optimizing the thermal environment. Dual digital temperature displays allow easy visualization of patient temperature and set point.

Control Panel

The Radiant Warmer comes complete with automatic manual /baby (Servo)/Air modes. In addition, the Skin/Air temperature display is larger than other set temperature display. Skin temperature display can be converted from °C to °F by the push of a button. A big LCD is provided for more information and visualizations of the heater power in manual and servo modes. A full complement of alarms provides safety and convenience, with both audible and visual indicators in the event of :

- High Temp./ Low Temp. • System Fail • Probe Failure • Power Failure • Timer • Heater fail / ON (Optional) only visual alarm provided

Heater Assembly

The Parabolic heater assembly located above the centre of the support structure consists of an integral examination light and a 650 watts heating system (Silica or quartz /Ceramic Heater) for quick warming and even distribution of heat on the baby bed. The heater can be swivelled in either direction for taking X-ray and doing procedures.

Air Mode (Optional)

The system comes with air sensor. This is added security cover with exclusive feature of switching OFF the heater in case the AIR temperature goes above 39°C irrespective of what the skin temperature is at the time of event.

Manual Mode

The system automatically starts heating from 40% in manual mode and the same can be changed through settings up to 100%. The system automatically converts from servo mode to manual mode in case of probe failure thus providing nonstop working of the unit.

Baby Bed

The spacious baby bed incorporates easy drop down/ fold down glasses for maximum access to the patient.

Optional: X-Ray facility is provided below the baby bed for taking X-ray of the baby without disturbing.

Additional Features

If needed the unit can be programmed by the user itself for any of the following features:

- (a) Count Up / down Timer.
- (b) Check baby Alarm.
- (c) Pre warming mode.

Castors

The system is fitted with 4" high quality castors having brakes in front 2 castors. Antistatic castors can be fitted as an option for further safety in lieu of the standard castors.

Optional : The system comes with check baby alarm (1 - 120min.)

Dimensions(Approx.)

Technical Specification

Height- 1850mm

Length- 1050mm

Width- 650mm

Electrical Specification

Power supply - 200V / 50Hz

Heater Power - 650 Watts

Fuse - 5 Amp.

INFANT RADIANT WARMER

MODEL - 2N



Intensive Care Resuscitation system 04



DISPLAY

SPECIAL FEATURES :

Micro computer controlled Graphic LCD to display the operating features, fault alarms, temperature settings etc. Dual digital actual temperature display for Baby and ambient that maintains the set temp as in LCD. High quality Ceramic heater source with stainless steel parabolic reflector and the protection grid. Rendered with bar LED indicator system to indicate the heater output % ON, while maintaining up to set value. Fitted with special halogen/LED spot light for operating the baby during while treatment or diagnoses. Baby bed can easily be tilted towards both sides for feeding and other procedure, can be repositioned and washable mattress which can easily be cleaned.



INTENSIVE CARE RADIANT WARMER 02



SPECIAL FEATURES :

Graphic LCD, seven segment display, all modes and operation display on LCD screen
High quality Ceramic heater source with stainless steel reflector. Rendered with bar LED indicator system to indicate the heater output.
Special halogen/ LED spot light for illumination to operate the patient.
Dual digital display for skin and air temperature.
Baby bed can easily be tilted for feeding and other procedure, and can be repositioned.
Side acrylic panel can be easily drop down and can also be pulled up to set right.
Two different calibrated sensor probes can be interchanged and used having best quality silicon wire for long lasting durability and easy to clean.
Auto mode control system also provided for non-stop working.
Alarm indication system for power failure, sensor open, temperature High/Low/over range.
Fitted with four antistatic castors for easy movement (two castors can be locked).

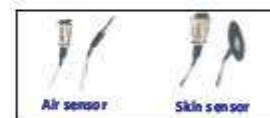

Air sensor

Skin sensor



INTENSIVE CARE RADIANT WARMER 01

TECHNICAL SPECIFICATION :

Supply Voltage	: 230V+20V Maximum
Supply Frequency	: 50/60Hz.
Heater Power	: 650W.
Temperature Range	: Set Temperature from 20-40 Degree)
Temperature Sensor	: PT 100.
Dimension (LXWXH)	: 68X48X180 cm.
Basinet (LXW)	: 68X48.
Accessories	: 40Kg (excluding suction section)
Heater Head Rotation	: 180o.
Castors	: 4 (2 Lockable, 2Unlockable)

INTENSIVE OPEN CAR WARMER 03

Side acrylic side panel can easily be drop down and also be pulled up to set right.
Two different calibrated sensor probes which can be interchanged and used having best quality silicon wire for long lasting durability and easy to clean.
Treatment time can also be feed up for time out treatment, auto mode control system also provided for non-stop working.
Alarm indication system for power failure, sensor open, temperature.
High/Low/over range, heater failure which gives signal for audio and visual.
Fitted with four antistatic castors for easy movement (two castors can be blocked) X-ray cassette inserting self underneath the baby bed, x-ray can be taken by moving the head of the warmer towards any of both side 90°.



**TOUCH SERIES
INTENSIVE CARE
RADIANT
WARMER
05**



SPECIAL FEATURES :

- Touch screen 5.9" TFT LCD display with operating features facility.
- Ceramic heating element with parabolic stainless steel reflectors.
- Heater unit can be swivelled towards both side 90° to accommodate x-ray unit.
- The control panel is ergonomically designed with soft touch key.
- **04/05** are equipped with halogen/LED spot light for examination.
- **05** is built in undersurface LED Photo therapy, suction device and oxygen attachment.
- Dual actual temperature display and setting for skin and Air.



TECHNICAL SPECIFICATION :

Supply Voltage	: 230V+20V Maximum
Supply Frequency	: 50/60Hz.
Heater Power	: 650W.
Temperature Range	: Set Temperature from 20-40 Degree in 0.1Degree Steps)
Temperature Sensor	: PT 100.
Dimension (LXWXH)	: 68X48X180 cm.
Basinet (LXW)	: 68X48.
Accessories	: 45Kg (excluding suction section)
Heater Head Rotation	: 180o.
Castors	: 4 (2 Lockable, 2Unlockable)

- Baby basinet can easily be tilted towards both side for feeding or other procedures.
- Side acrylic panels can easily be drop down and pulled up to set right.
- Two different calibrated sensor probes can be inter changed, used best quality silicon wire for durability and performance.
- Comprising alarms for power fail, sensor open, temp
- Hi/lo and over and lower range.
- Fitted with 4 antistatic casters for easy movement, flow meter, humidifier bottle and pressure gauge.
- Inbuilt suction with oxygen attachment.



**TOUCH SERIES
INTENSIVE CARE
RESUSCITATION
SYSTEM
06**



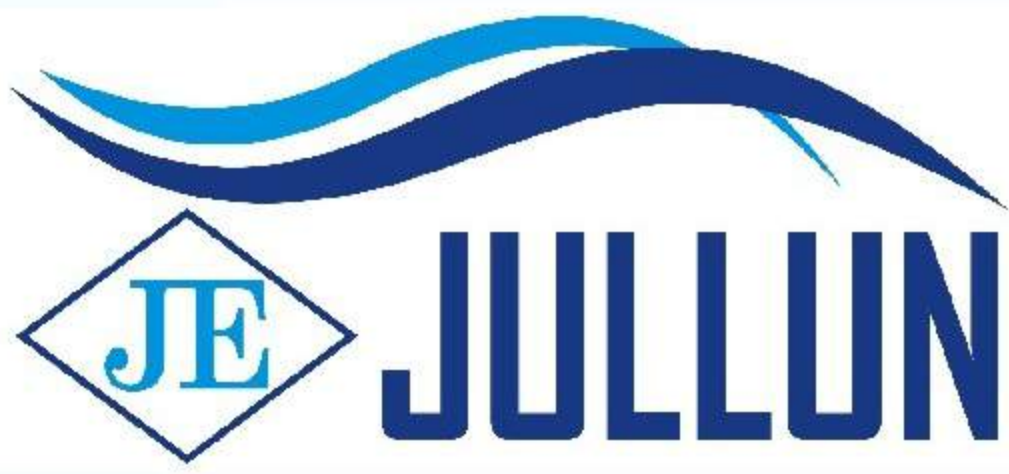

JULLUNDUR ENTERPRISES

India's Leading Manufacturer of Pediatric Equipments



INFANT RADIANT WARMER MODEL - 3N



OPEN CARE SYSTEM

open care system that comes in fiber and powder coated MS, allow you to efficiently care and provide advance warming capabilities while using one touch operations to simplify procedures. Advance microprocessor controlled system with self-check on the electronic circuitry skin / air / manual control. Latest technology packed with higher accuracy & enhanced visibility has been integrated in the system

Control Panel

open care system comes with automatic manual and baby (Servo) modes.

In addition, the Skin/Air temperature display is larger than other set temperature display. Skin temperature display can be converted from °C to °F by the push of a button. A big LCD is provided for more information and visualizations of the heater power in manual and servo modes. A full panel of alarms provides safety and convenience, with both audible and visual indicators in the event of:

- High Temp./ Low Temp.
- System Fail
- Probe Failure
- Power Failure
- Timer -On
- Heater fail / ON (Optional) only visual alarm provided

Heater Assembly

The heater assembly located above the centre of the support structure consists of an integral examination light and a 650 watts heating system (Silica/ Quartz /Ceramic Heater) for quick warming and even distribution of heat on the baby bed. The heater can be swivelled in either direction for taking X-ray and doing procedures. The Heater is also equipped with LED Phototherapy on both side to provide light intensity effective on the baby bed

Air Mode (Optional)

The system comes with air sensor. This is added security cover with exclusive feature of switching OFF the heater in case the AIR temperature goes above 39°C irrespective of what the skin temperature is at the time of event

Technical Specification

Technical Specification	Electrical Specification
Height-1850mm	Power supply - 200V / 50Hz
Length-1050mm	Heater Power - 650 Watts
Width-650mm	Fuse - 5 Amp

Additional Features

If needed the unit can be programmed by the user itself for any of the following features:
(a) Count Up / down Timer.
(b) Check baby Alarm. (OPTIONAL).
(C) Pre warming mode

Manual Mode

The system automatically starts heating from 40% in manual mode and the same can be changed through settings up to 100%. The system automatically converts from servo mode to manual mode in case of probe failure thus providing nonstop working of the unit.

Baby Bed

The spacious baby bed incorporates easy drop down/ fold down glasses for maximum access to the patient. Optional: X-Ray facility is provided below the baby bed for taking X-ray of the baby without disturbing

Led Phototherapy (Optional)

Tiana D comes with choice of highly efficient and bright 12/15 choice of LEDs on each side of the heater. The strong lux of 24/30 LEDs cure jaundice in baby rapidly

Technical Specification

Light Source :- High Bright Blue / Whit LEDs

INFANT RADIANT WARMER

MODEL - 3N



TRANSPORT INCUBATOR



Control Panel

The controller features a display that is easy to read at any angle during transport. Display for air and skin temperature help you maintain, control and provide essential information about the infant's thermal support. Microprocessor controlled system with air and skin modes of operation. Display both temperatures i. e. Air/Skin temp along with Set temp. Soft touch operation with digital display and extensive alarms.

Alarms

• Skin temp low / high • Probe failure • Low battery • Power failure • System Failure • Timer

In case of high temperature i.e. above 38°C, heater automatically cuts off thus ensuring baby's safety.

Can be used on manual mode as well.

Collapsible Stainless Steel Stand

With 2/4 no. gas springs for ambulance and in hospital transport purposes. Gas spring system allow the stand to collapse when the lever is pulled and trolley is pressed from both the sides.

Performance characteristics

Temperature set range : 32°C - 39°C

Temp variability : 1.0°C

Temp uniformity : 1.0°C

Air filter : removes airborne particles & dust

Power Source

Transport incubator operates on AC or DC power using AC when available or switching to its internal battery when necessary

Battery : The batteries used in the system are 12 volt 18ah. Sealed maintenance free VRLA batteries.

Charge Time : 8-10 hrs. per battery from full discharge.

Hood options : Standard single wall / double wall hood (on demand).

Chassis Body : Plastic (fibre) to shock proof the system

Control Displays

Battery condition status : single led indication of low battery condition on the side panel

Power mode : Illuminates AC, DC or external DC

Air/Baby temp °C : displays incubator air temp / baby temperature

Dimensions in inches (Approx.)

Height without hood : 39"

In collapsible stand mode : 29"

height with hood : 49"

Width : 23"

Length : 53"

Baby bed : 20x11"

Weight : 75kg

Backup : 60-90mins

Size of Castors : 5" PU

Sealed maintenance free battery : VRLA Batteries

Charge time : 10hrs.(Approx.)

Easy Access

Quick and easy access through the side access door and front port holes. The side door folds down and the mattress retracts out from the hood to access for emergency procedures. The door and tubing ports offer ventilator tubing support. Infant restraint strap attached to the baby bed.

Standard Features

- Single wall Hood • Skin temperature probe / Air temp. Probe
- 2 access doors • 1 baby belt • Collapsible trolley

Optional

- Examination lamp • 2 disposable infant restraint straps • 1 Iris port • 6 tubing ports • Accessory shelf • Suction, Oxygen cylinder, pressure regulatory assembly, Flow Meter, Remote Controlled movement of the Trolley.

NEONATAL TRANSPORT INCUBATOR

with Autoloading Trolley



Features



Bacteria Filter



Front & Head access door



Wide Space for Baby



Sliding Mattress



Two port holes & Openable door to access baby
Double Wall Canopy (Optional)

Technical Specifications

Dimensions

LENGTH	26 inch
BREADTH	15 inch
HEIGHT	15 inch
BABY AREA	20 inch x 13 inch
VERTICAL SPACE	8 inch

Temperature Control

SUPPLY VOLTAGE	190V - 250 VAC
SUPPLY FREQUENCY	50 - 60 Hz
POWER CONSUMPTION	150W
TEMPERATURE DISPLAY	Celsius / Fahrenheit
TEMPERATURE RANGE	10°C - 50°C
TEMPERATURE RESOLUTION	0.1°C
TEMPERATURE ACCURACY	± 0.2°C
SET TEMPERATURE RANGE	30 - 38°C
HEATER OUTPUT RANGE	0 - 100% in steps of 1%
PROBE INTERCHANGEABILITY	± 0.2°C
MODES OF OPERATION	Baby, Manual
ALARMS	Audio and Visual

General features

WHEELS	Strong Castor wheels with 2 brake
MATTRESS	Waterproof, Washable, Flame Resistant
MATTRESS FOAM DENSITY	21- 25 kg/m ³
INFUSION PUMP STAND	Stainless Steel rod
TEMPERATURE SENSOR	Thermistor based NTE Sensors with high resolution

Alarms

HIGH TEMPERATURE	If Temp > Set Temp + 1°C
LOW TEMPERATURE	If Temp < Set Temp - 1°C
OVERHEAT	If Temp > 38°C (Baby)
SENSOR FAILURE	Sensor disconnection / not working
POWER FAILURE	If Power fails
BATTERY FAILURE	Rechargeable battery for power failure
SYSTEM FAILURE	If system hangs
HEATER FAILURE	If Heater stops working

NEOTHERM Control

PID based Servo Temperature Control with fast Air Circulation. PID is the most advanced servo control system which considers even smallest change in temperature





SPECIAL FEATURES :

Advance micro controller based system. Graphic LCD, Digital Display with complete operation with instructions in LCD with alarms

High quality IR (ceramic) heating source with air circulating housing and inbuilt fans.

Mains power LED in indicator.

Digital display system indicates infant temperature, air temperature around the infant in to the canopy and an LED bar for displaying the heater ON percentage.

Humidity chamber is provided for humidity into the canopy. Two shelves are provided underneath the main unit, IV pole is also attached. Oxygen port both side of the unit is provided, four doors are provided two at front and two at side panels.



TECHNICAL SPECIFICATION :

Supply Voltage	: 230V+20V Maximum.
Supply Frequency	: 50Hz.
Heater Power	: 650W.
Temperature Range	: Set Temperature from 20-40 Degree.
AC Blowers	One for to blow hot air and other to Suck the air from the canopy.
Temperature Sensor	: PT 100
Dimension (LXWXH)	: 27X17X34 inch (excluding canopy, handle and gas Cylinder holder).
Weight Without Accessories	: 45 Kg (excluding suction and canopy).
Castors	: 4 (2 Lockable, 2 Unlockable).
Baby Bed Tilt Angle	: 30 Degrees (both sides)

LCD display to program all parameters of temp pre-adjusted and alarms if any fault occurs. Auto mode digitally controlled through a pre set of program.

Rendered with bar LED indicator system to indicate the heater output. Alarm audio/visual system for power failure, sensor open, temperature High/Low/ over range.

Mounted on 4" wheels to move the incubator easily to move from one place to another for cleaning or other purpose with break system to hold at one place.

Auto mode control system also provided for non-stop working.

Baby bed can be easily tilted for feed or for any other procedure and can also be repositioned.

Two different calibrated sensor probes can be inter changed and used having best quality silicon wire for long lasting durability and easy to clean.

Alarm audio/visual system for power failure, sensor open, temperature High/Low/ over Range.

Mounted on 4" wheels to move the incubator easily to move from one place to another for cleaning or other purpose with break system to hold at one place.

Auto mode control system also provided for non-stop working.

Baby bed can be easily tilted for feed or for any other procedure and can also be repositioned.

Two different calibrated sensor probes can be inter changed and used having best quality silicon wire for long lasting durability and easy to clean.



INTENSIVE CARE BABY INCUBATOR



ELECTRO MEDICAL EQUIPMENT CATALOG



ISO 9001 : 2008
ISO 13485 : 2012
CE CERTIFIED

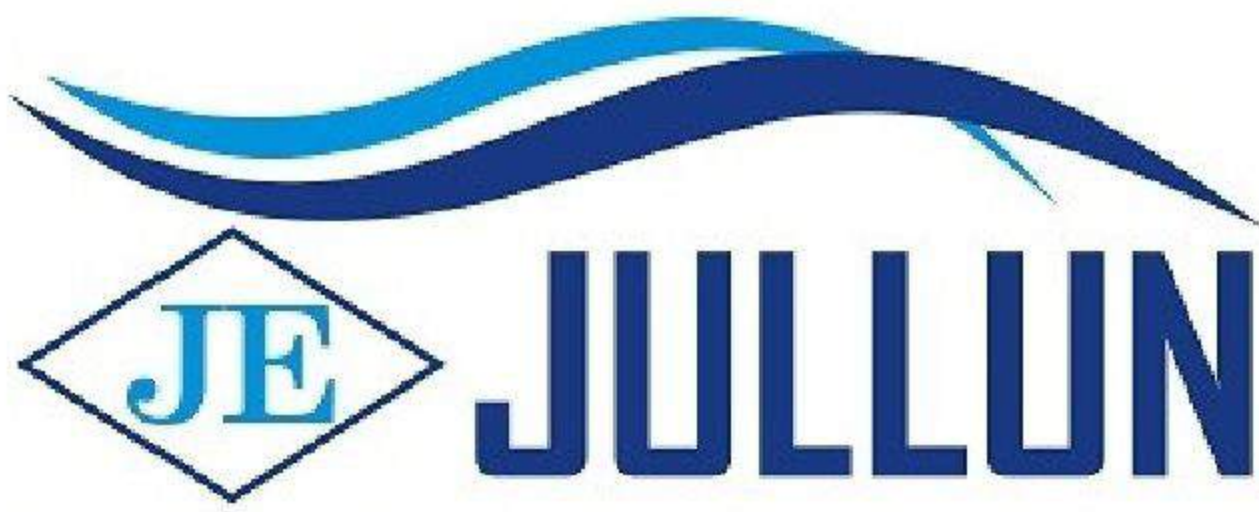

JULLUNDUR ENTERPRISES



Fingertip Pulse Oximeter



Table Top Pulse Oximeter



Fingertip Pulse Oximeter



CMS-60C Pulse Oximeter (Hand Held)



CMS-60D Pulse Oximeter (Hand Held)



Pulse Oximeter with NIBP



Pulse Oximeter with NIBP



Multi Parameter Patient Monitor



Multi Parameter Patient Monitor



Patient Monitor



Patient Monitor



Multi Parameter Patient Monitor



Multi Parameter Patient Monitor



Multi Parameter Patient Monitor



ECG Machine Single Channel



ECG Machine Three Channel

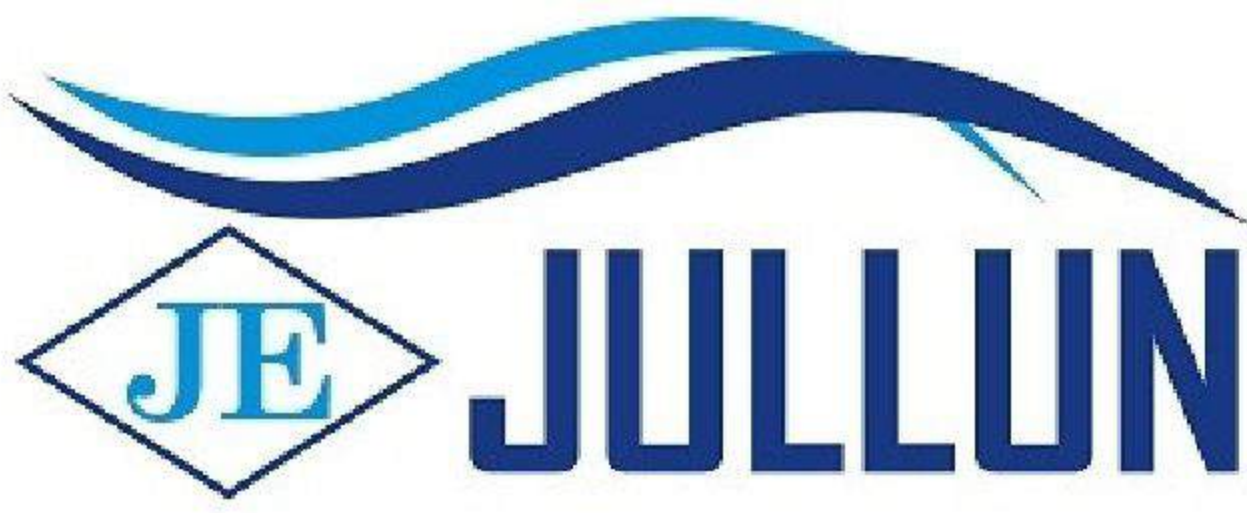

JULLUNDUR ENTERPRISES



ECG Machine Three Channel



ECG Machine Six Channel



ECG Machine Twelve Channel



Desktop Fetal Doppler



Pocket Fetal Doppler



Fetal Doppler



Fetal Monitor



Fetal Monitor



Phototherapy



Head lamp



Infusion Warmer



Manual Breast Pump



Handheld Etco2



GII Auto CPAP



GII Bi-PAP



Bi-PAP

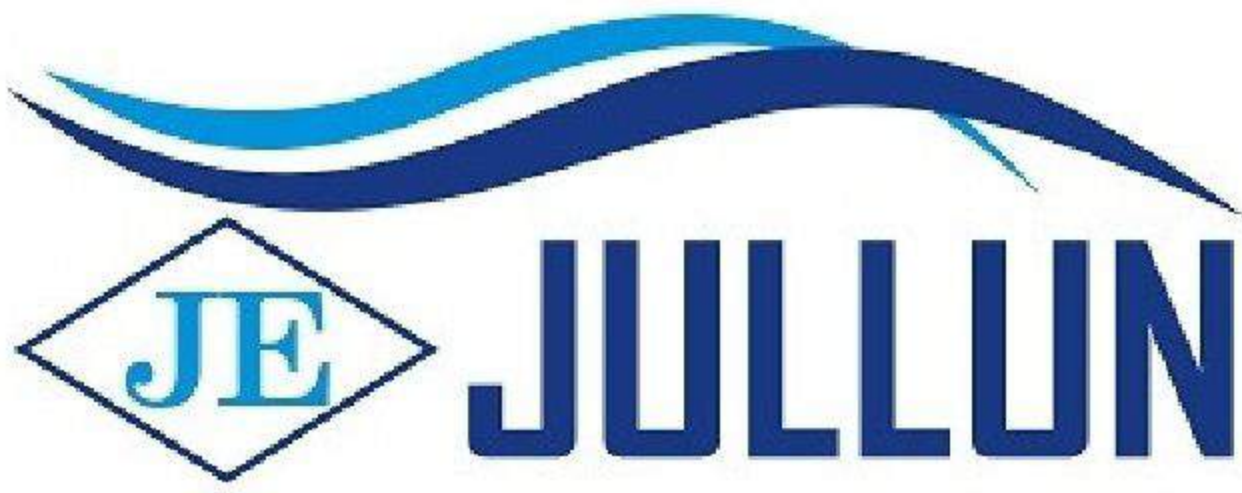

JULLUNDUR ENTERPRISES



SINGLE FLOW



FULL FACE MASK



NASAL MASK



CPAP



DUAL FLOW



Portable Oxygen Concentrator



**Sphygmomanometer
Mercury - Free**



Digital Thermometer



**Ambulatory Blood
Pressure Monitor**



**Digital Blood
Pressure Monitor**



Aneroid Table Model



Syringe Pump



Infusion Pump



Infrared Medical Lamp



Spirometer



Anti-Decubitus Pump System

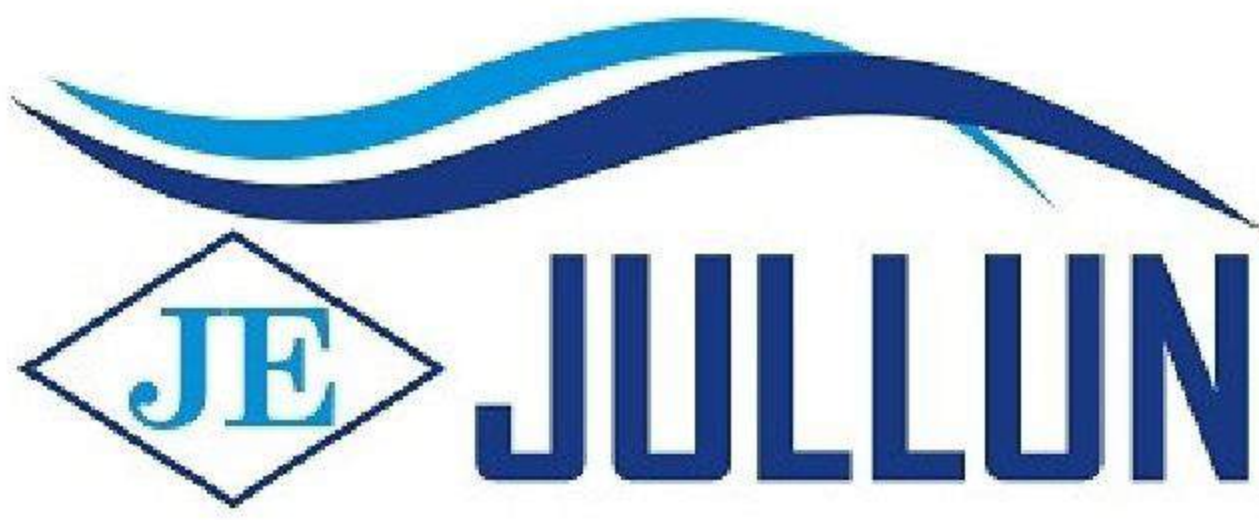

JULLUNDUR ENTERPRISES



Nebulizer



Ultrasonic Nebulizer



Hand Suction



Pedal Suction



Portable Phlegm Suction



Trolley Model Suction



Trolley Model Suction



Portable Suction



Portable Suction



Trolley Model Suction



Trolley Model Suction



**Autoloader
Collapsible Stretcher**



**Stretcher cum
Wheelchair**



Stair Stretcher



Aluminum Moldable Splint



Cervical Collar

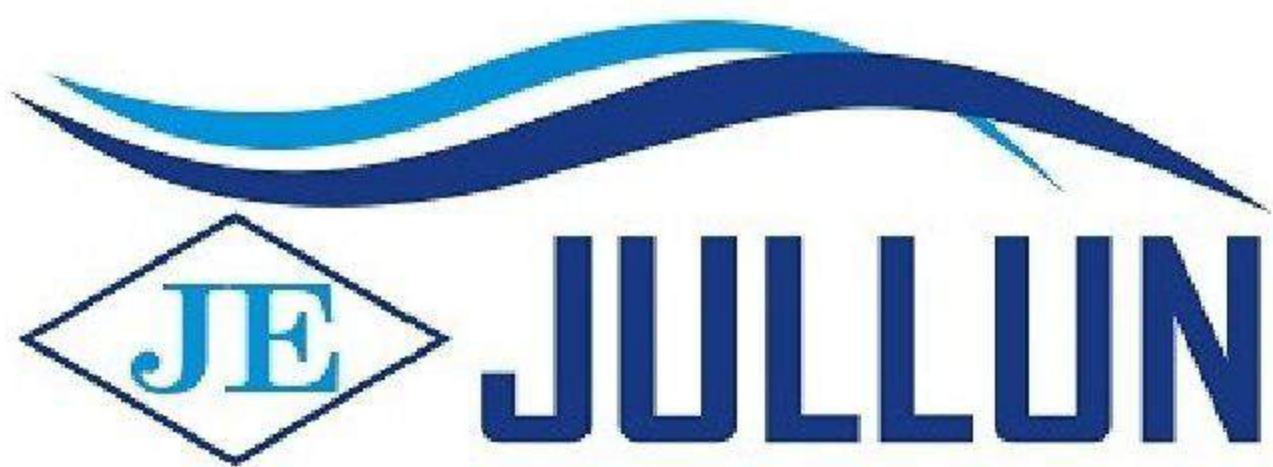

JULLUNDUR ENTERPRISES



Splint



Electronic Stethoscope



Hot Water Bottle



Electric Warmer Bag



**The POWERHEART AED
G3 Automatic/Semi Auto**



**Automatic
External Defibrillator**



AED Trainer

JULLUNDUR ENTERPRISES

JULLUNDUR ENTERPRISES

THE MARK OF QUALITY & CRAFTSMANSHIP



GENERAL SURGICAL INSTRUMENTS

**The House Known For
Surgical Instruments**



JULLUNDUR ENTERPRISES

Manufacturer & Exporter Of Surgical Instruments



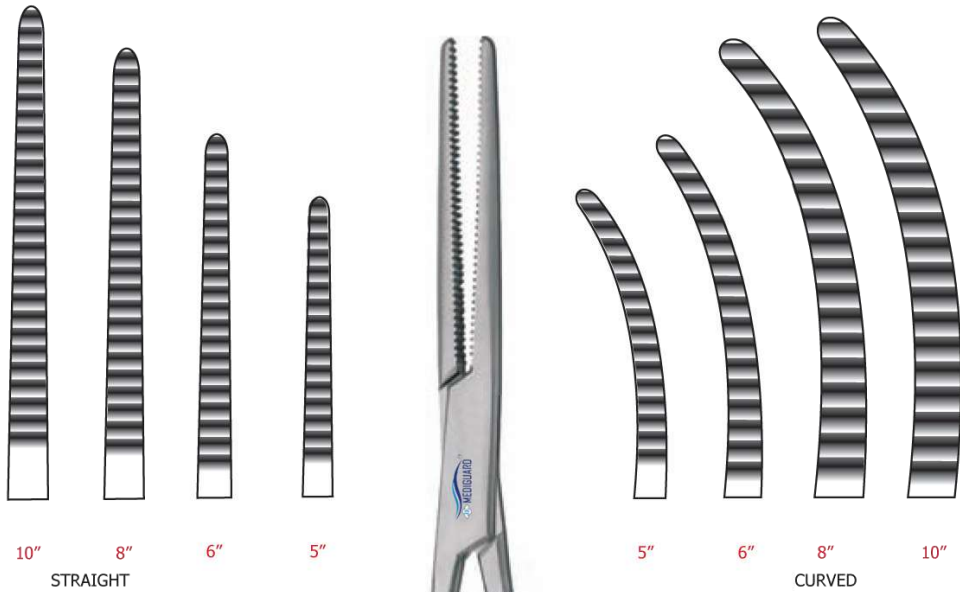

SPENCER WELLS ARTERY FORCEPS
STRAIGHT CURVED

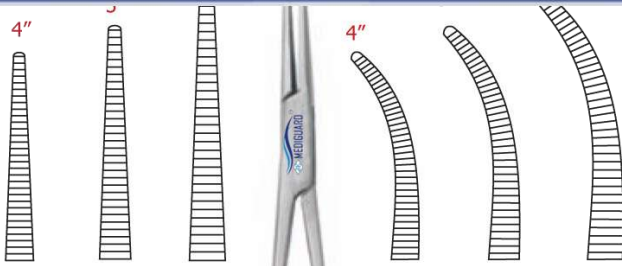

STRAIGHT

CURVED

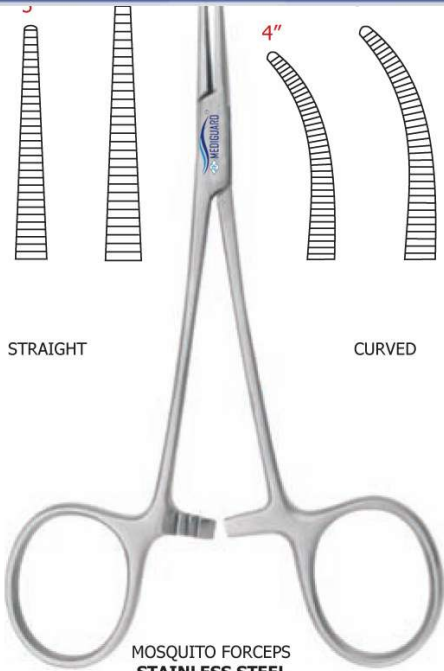

**MOSQUITO FORCEPS
STAINLESS STEEL**

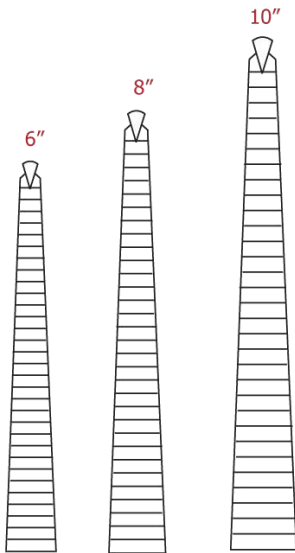

STRAIGHT



**KOCHER'S
ARTERY FORCEPS
STRAIGHT**



**KOCHER'S
ARTERYFORCEPS
CURVED**

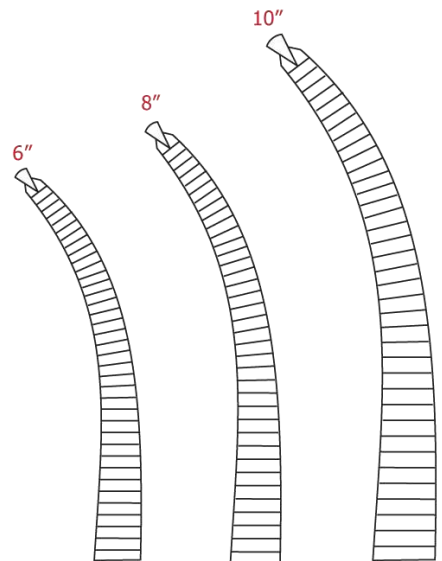

CURVED

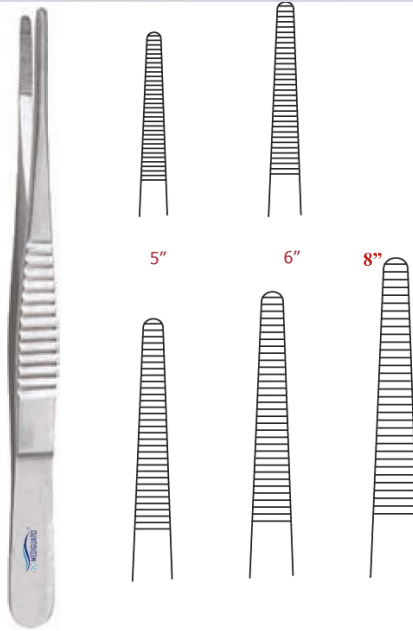

DISSECTING FORCEPS
STAINLESS STEEL - PLAIN SHARP / BLUNT

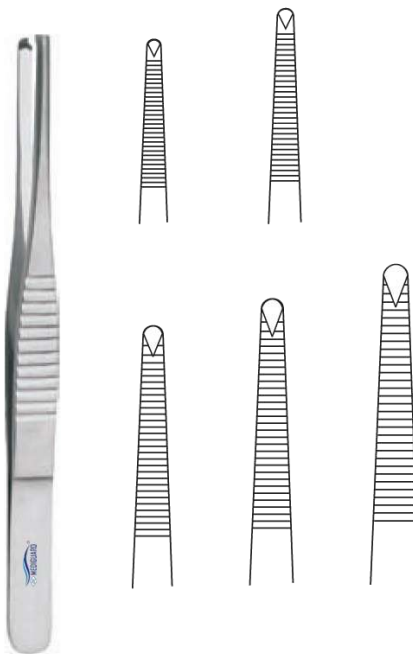

DISSECTING FORCEPS **TOOTH**



**RUSSIAN DISSECTING
FORCEPS**



**FINE DISSECTING
FORCEPS - PLAIN**

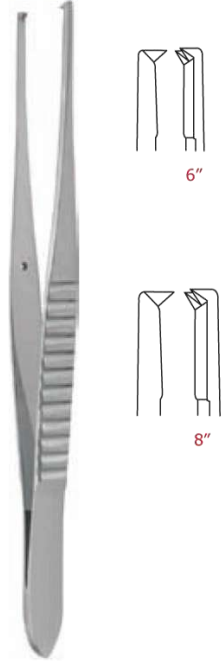

**FINE DISSECTING
FORCEPS - TOOTH**



**DENNIS BROWNE
DISSECTING FORCEPS**

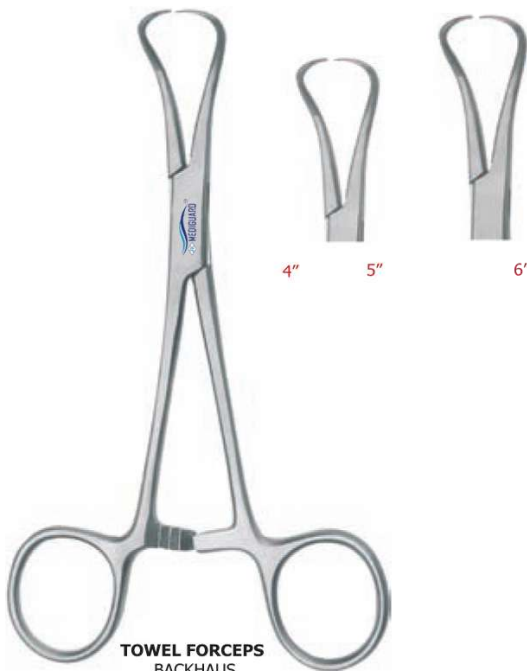

**TOWEL FORCEPS
BACKHAUS**



**TOWEL CLIP
CROSS-ACTION**



B.P. HANDLE NO. 3



B.P. HANDLE NO. 4



B.P. HANDLE NO. 7



**MALLEBLE PROBE
WITH EYE**



**LISTER SINUS
DRESSING FORCEPS**



10



11



12



15



20



21



22



23



24

BARD PARKER BLADES
No. 10, 11, 12, 15, 20, 21, 22, 23, 24

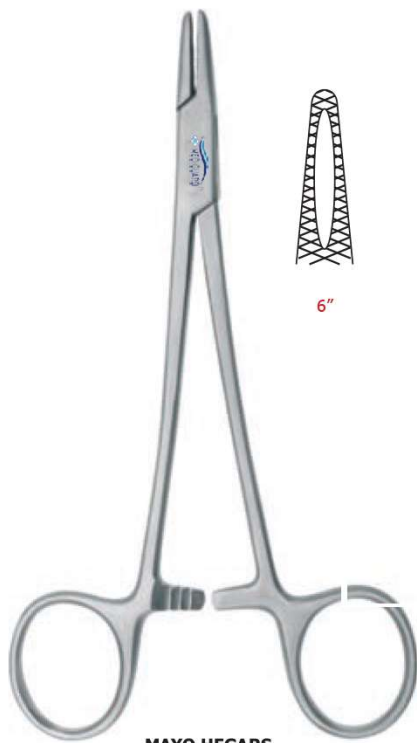

**MAYO HEGARS
NEEDLE HOLDERS
STRAIGHT
STAINLESS STEEL**

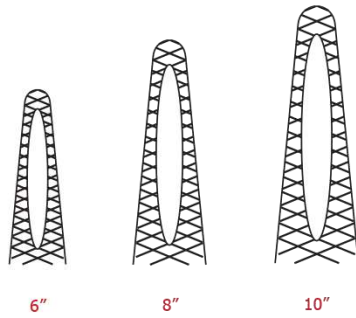

6"

8"

10"



**MAYO HEGARS
NEEDLE HOLDERS
STRAIGHT
TUNGSTEN CARBIDE**

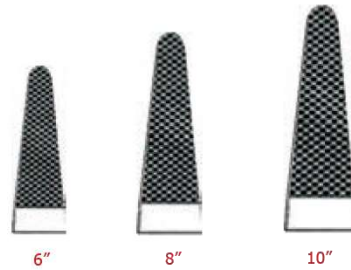

6"

8"

10"

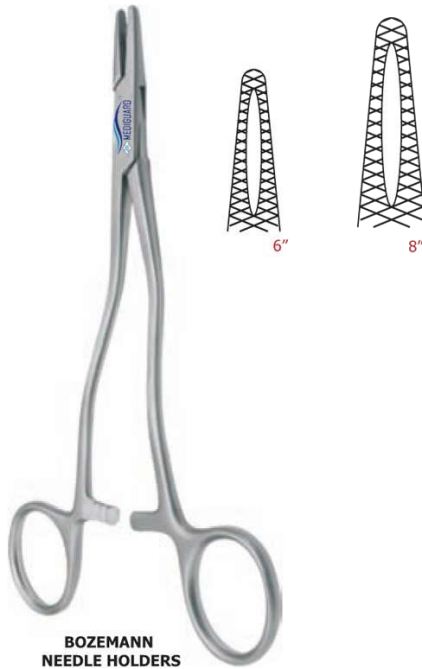

**BOZEMANN
NEEDLE HOLDERS
STRAIGHT
STAINLESS STEEL**

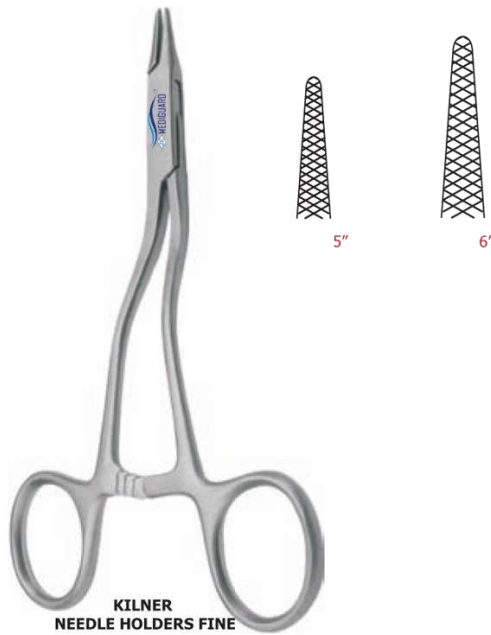

**KILNER
NEEDLE HOLDERS FINE
STRAIGHT
STAINLESS STEEL**



DRESSING SCISSORS
STRAIGHT (SHARP x BLUNT)
STAINLESS STEEL
5"
6"



DRESSING SCISSORS
CURVED (SHARP x BLUNT)
STAINLESS STEEL
5"
6"



DRESSING SCISSORS
STRAIGHT (SHARP x SHARP)



DRESSING SCISSORS
CURVED (SHARP x SHARP)
STAINLESS STEEL
5"
6"



IRIS SCISSORS
STRAIGHT
STAINLESS STEEL

IRIS SCISSORS
CURVED
STAINLESS STEEL



IRIS SCISSORS
STRAIGHT
SUPER CUT

IRIS SCISSORS
CURVED
SUPER CUT



**KNAPP SCISSORS
STRAIGHT
STAINLESS STEEL**

**KNAPP SCISSORS
CURVED
STAINLESS STEEL**



**KNAPP SCISSORS
STRAIGHT
TUNGSTEN CARBIDE**

**KNAPP SCISSORS
CURVED
TUNGSTEN CARBIDE**



**KNAPP SCISSORS
STRAIGHT**

**KNAPP SCISSORS
CURVED
SUPER CUT**



STITCH RIBBON SCISSORS
STRAIGHT
STAINLESS STEEL



STITCH RIBBON SCISSORS
CURVED
STAINLESS STEEL



STITCH RIBBON SCISSORS
STRAIGHT
SUPER CUT



STITCH RIBBON SCISSORS
CURVED
SUPER CUT



**METZENBAUM SCISSORS
STRAIGHT
STAINLESS STEEL**

6"
8"
10"



**METZENBAUM SCISSORS
CURVED
STAINLESS STEEL**

6"
8"
10"



**METZENBAUM SCISSORS
STRAIGHT
TUNGSTEN CARBIDE**

6"
8"



**METZENBAUM SCISSORS
CURVED
TUNGSTEN CARBIDE**

6"
8"



**METZENBAUM SCISSORS
STRAIGHT
SUPER CUT**



**METZENBAUM SCISSORS
CURVED
SUPER CUT**



**MAYO SCISSORS
STRAIGHT
STAINLESS STEEL**



**MAYO SCISSORS
CURVED
STAINLESS STEEL**



**MAYO SCISSORS
STRAIGHT
TUNGSTEN CARBIDE**



**MAYO SCISSORS
CURVED
TUNGSTEN CARBIDE**



**MAYO SCISSORS
STRAIGHT
SUPER CUT**



**MAYO SCISSORS
CURVED
SUPER CUT**



**GREEN BERG
SCISSORS (KILNER)
CURVED
STAINLESS STEEL**

**GREEN BERG SCISSORS
(KILNER)
STRAIGHT
STAINLESS STEEL**



**GREEN BERG
SCISSORS (KILNER)
CURVED
TUNGSTEN CARBIDE**

**GREEN BERG SCISSORS (KILNER)
STRAIGHT
TUNGSTEN CARBIDE**



**GREEN BERG SCISSORS
(KILNER)
CURVED
SUPER CUT**



**GREEN BERG SCISSORS (KILNER)
STRAIGHT
SUPER CUT**



**STEVENS SCISSORS
STRAIGHT
STAINLESS STEEL**



**STEVENS SCISSORS
CURVED
STAINLESS STEEL**



**STEVENS SCISSORS
STRAIGHT
TUNGSTEN CARBIDE**



**STEVENS SCISSORS
CURVED
TUNGSTEN CARBIDE**



**STEVENS SCISSORS
STRAIGHT
SUPER CUT**



**STEVENS SCISSORS
CURVED
SUPER CUT**



**HEATH SUTURE
REMOVAL SCISSORS**



**LISTRE BANDAGE
CUTTING SCISSORS**
5 1/2"
7 1/2"



**GAUGE
CUTTING SCISSORS**
9"



**POTT'S ANGLED
SCISSORS**
STAINLESS STEEL



**O' BRIEN STITCH REMOVAL
ANGULAR SCISSORS**
TUNGSTEN CARBIDE



ALLIS TISSUE GRASPING FORCEPS
STAINLESS STEEL



ALLIS TISSUE GRASPING FORCEPS
TUNGSTEN CARBIDE



LANES TISSUE FORCEPS



BAB COCK GRASPING FORCEPS
STAINLESS STEEL



BAB COCK GRASPING FORCEPS
TUNGSTEN CARBIDE



DISSECTOR
McDONALD
7149



LAHEY'S
FORCEPS
7140



MIXTURE LIGATURE
RIGHT ANGLED FORCEPS



6"
8"
10"



DIRECTOR WITH ANEURYSM
NEEDLE



THYROID DISSECTOR



JOLLS THYROID
RETRACTOR



**HYSTERECTOMY
MAINGOTS FORCEPS
STRAIGHT**



**HYSTERECTOMY
MAINGOTS FORCEPS
CURVED**

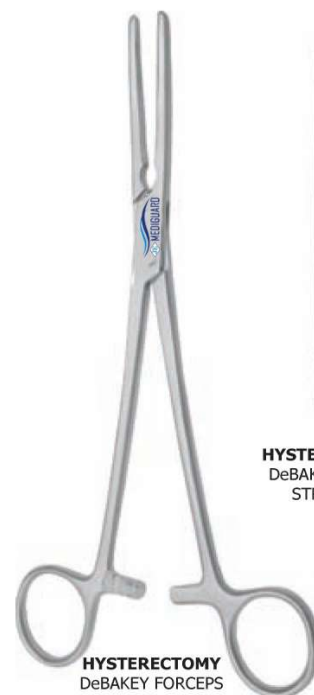

**HYSTERECTOMY
DeBAKEY FORCEPS**



**HYSTERECTOMY
DeBAKEY CLAMP
STRAIGHT**



**HYSTERECTOMY
DeBAKEY CLAMP
CURVED**



**HEANYS HYSTERECTOMY
FORCEPS SINGLE TOOTH
STRAIGHT**



**HEANYS HYSTERECTOMY
FORCEPS SINGLE TOOTH
CURVED**



**HEANYS
HYSTERECTOMY
FORCEPS DOUBLE TEETH
STRAIGHT**



**HEANYS HYSTERECTOMY
FORCEPS DOUBLE TEETH
CURVED**



**SUPRAPUBIC TROCARS
& CANNULA**



VEIN STRIPPERS



**HERNIA
RING FORCEPS**



**BOWL LIFTING
FORCEPS
12"**



**MAYO SAFETY PIN
INSTRUMENT HOLDER**



**CHEATLE
JAR**



**CHEATLE
FORCEPS**



**KILNER
SKIN RETRACTOR**



**SHARP
7175**



**BLUNT
2014**



**DOUBLE
HOOK RETRACTOR
5025**



**GILLIES
SKIN HOOK**



**RIBBONS CARINS
STRIP RETRACTOR
MALLEABLE RETRACTOR**



CZERNY RETRACTOR
6"
8"

**LANGENBECK
RETRACTOR
SMALL**



**LANGENBECK
RETRACTOR
LARGE**



**LANGENBECK RETRACTOR
WITH FIBER OPTIC LIGHT CARRIERS
ALONG WITH SUCTION**



**LANE'S RETRACTOR
SET OF 2**

**ROUX RETRACTOR
SET OF 3**



**LONDON
VAGINAL RETRACTOR
RIGHT ANGLED**





**DEAVERS
RETRACTOR**



**DEAVERS RETRACTOR
ADULT**



**DEAVERS RETRACTOR
WITH FIBER OPTIC LIGHT CARRIER
ADULT**



**KELLY'S
RETRACTOR**



**VOLKMANN RETRACTOR
SHARP**
3 PRONG
4 PRONG
5 PRONG



**VOLKMANN RETRACTOR
BLUNT**
3 PRONG
4 PRONG
5 PRONG



MORRIS RETRACTOR



**MORRIS RETRACTOR
WITH FIBER OPTIC
LIGHT CARRIER**

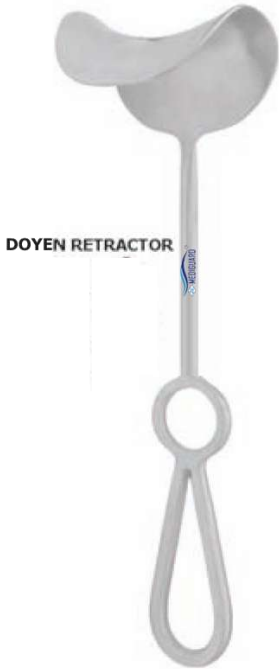

DOYEN RETRACTOR



**DOYEN RETRACTOR
WITH FIBER OPTIC
LIGHT CARRIERS**



**JANSEN
RETRACTOR**



WULLSTEIN SELF RETAINING RETRACTOR
2x3 TEETH
3x4 TEETH



WEISLANDER RETRACTOR
3x3 TEETH
4x5 TEETH



ADSON RETRACTOR
5x4 PRONGS



**(BALFOUR) ABDOMINAL
SELF - RETAINING RETRACTOR**



**(BALFOUR) ABDOMINAL
SELF - RETAINING RETRACTOR
CHILD**



**POZZI SELF-RETAINING RETRACTOR
WITH THREE BLADE**



**PARKS ANAL
RETRACTOR**



**THOMSON WALKER BLADDER
RETRACTOR**



**MILLIAN BLADDER
RETRACTOR**



PENILE CLAMP

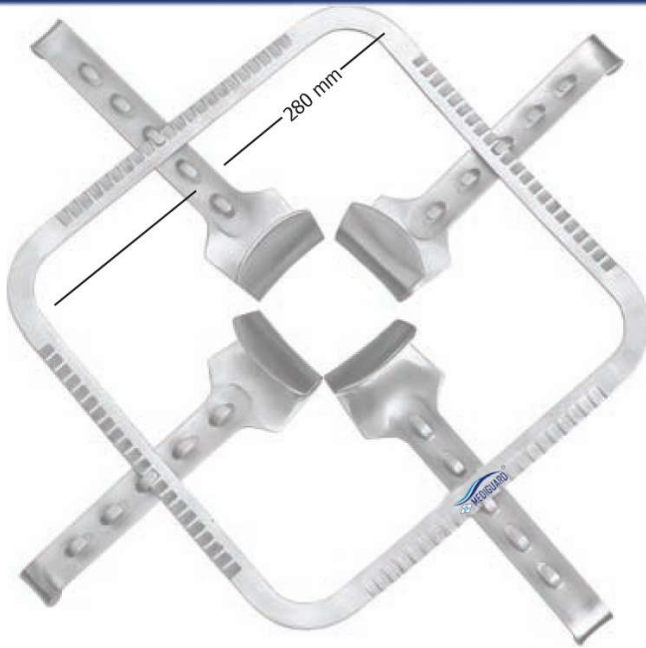

**ABDOMINAL RETRACTOR
KIRSHNER SET OF 4 BLADES**

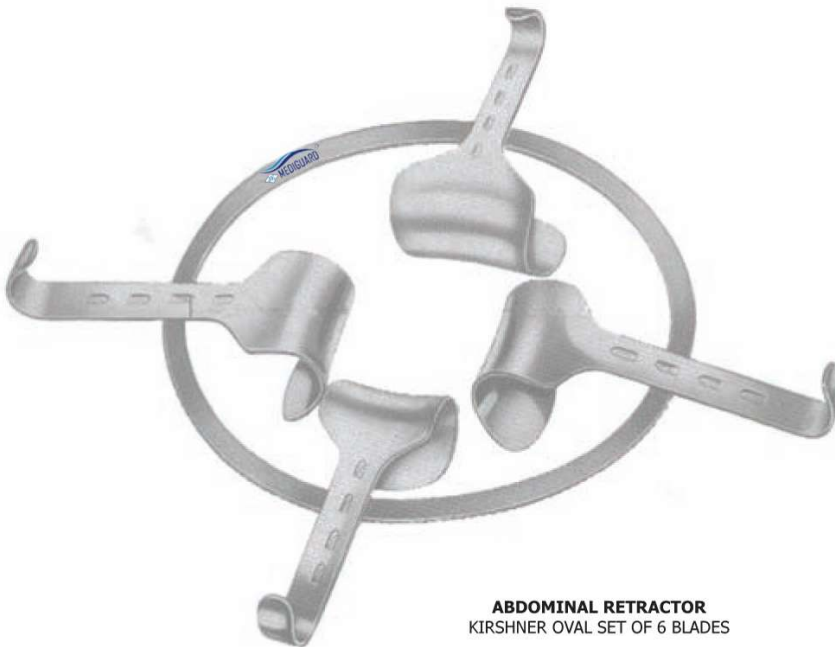

**ABDOMINAL RETRACTOR
KIRSHNER OVAL SET OF 6 BLADES**



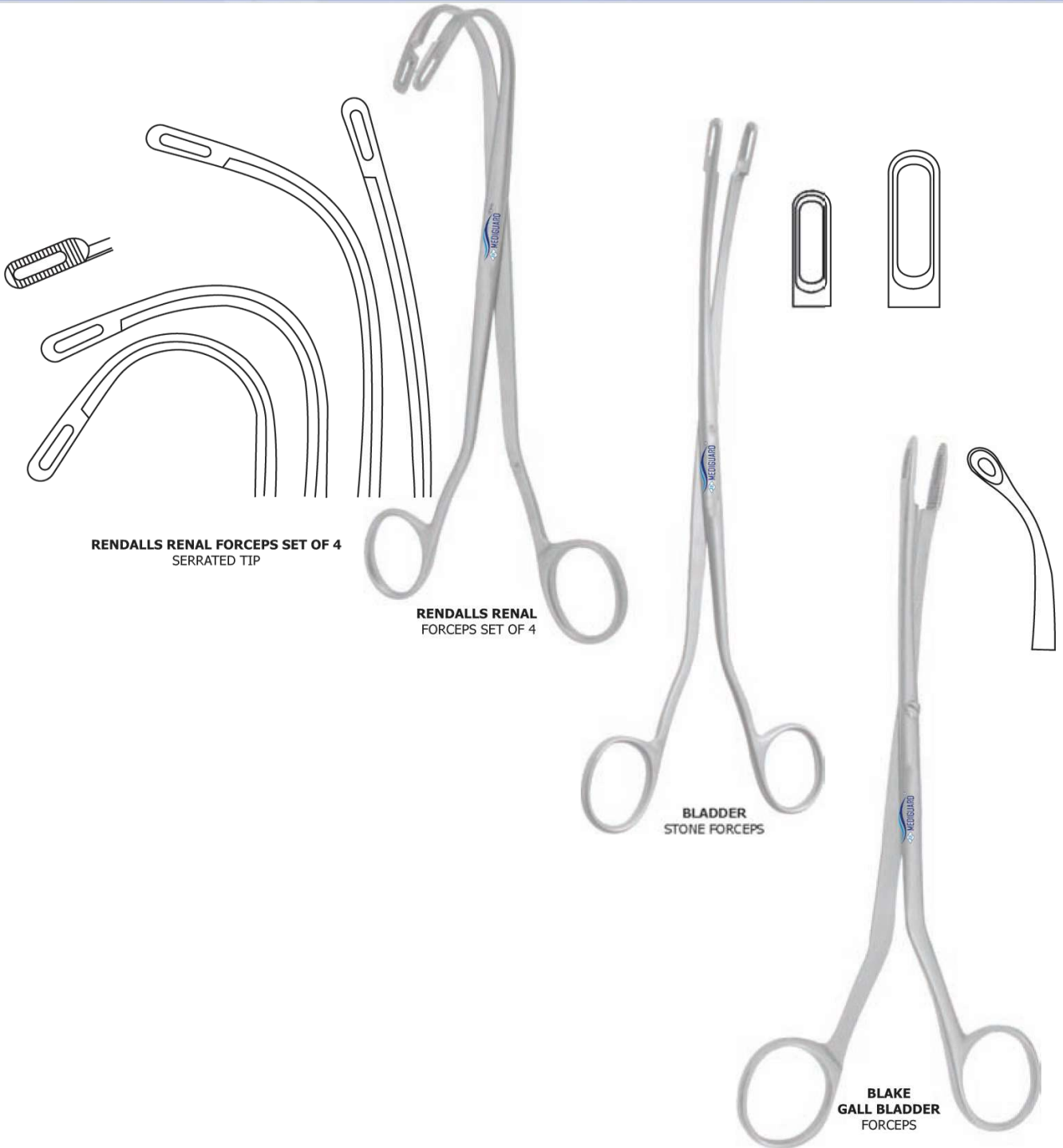

RENDALLS RENAL FORCEPS SET OF 4
SERRATED TIP

RENDALLS RENAL
FORCEPS SET OF 4

BLADDER
STONE FORCEPS

BLAKE
GALL BLADDER
FORCEPS



**LISTER UREATHAL
DILATOR SET OF 12**



**CLUTTON UREATHAL
DILATOR SET OF 12**



CATHETER INTRODUCER



**MALE CATHETER
SET OF 10**



**BLADDER
NECK SPREADER**



KELLY'S RECTAL SPECULUM
 SMALL
 MEDIUM
 LARGE
 EXTRA LARGE



MATHIEU RECTAL SPECULUM
 TRIVALVE SELF RETAINING
 WITH FIBER OPTIC LIGHT CARRIER



ST. MARKS RECTAL DILATOR
 NO.1
 NO.2
 NO.3
 NO.4



KELLY'S RECTAL SPECULUM
 WITH FIBER OPTIC CARRIER
 SMALL
 MEDIUM
 LARGE
 EXTRA LARGE



**HAEMORRHOIDAL
LIGATING GUN**

**PILES BAND
RUBBER**



**HAEMORRHOIDAL LIGATING
FORCEPS**



**HAEMORRHOIDAL LIGATING
WITH SUCTION**



SMALL MEDIUM LARGE



SIGMOID SCOPE WITH FIBER OPTIC LIGHT CARRIER

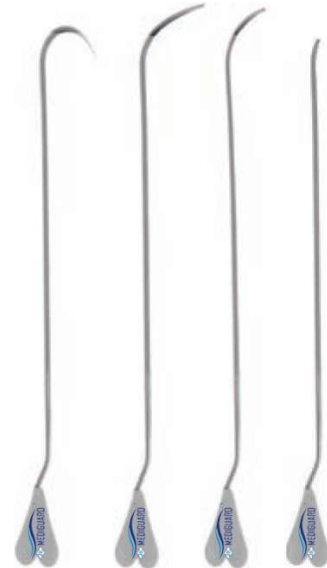

**FISTULA DIRECTORS
NO.1
NO.2
NO.3
NO.4**



**DOYEN
INTESTINAL
CLAMP**



**DOYEN INTESTINAL
CLAMP
STRAIGHT
6"
8"
10"**



**DOYEN INTESTINAL
CLAMP
CURVED
6"
8"
10"**



**GREEN
ARMYTAGE
FORCEPS**



LANES TWIN
INTESTINAL CLAMPS
STRAIGHT



LANES TWIN
INTESTINAL CLAMPS
CURVED



PAYRS CRUSHING
INTESTINAL CLAMP



70MM



110MM

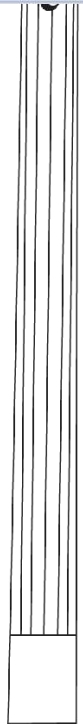

145MM



3MM

4MM

5MM

6MM

7MM

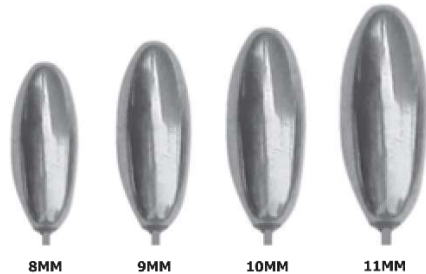

8MM

9MM

10MM

11MM

BAKE BILE DUCT
DILATORS SET OF 9





SPINAL NEEDLE
No. 18, 20, 21, 22



SILVER BIOPSY NEEDLE



STERNAL PUNCTURE NEEDLE



PERCUSSOR HAMMER



PERCUSSOR HAMMER T-SHAPE



MEGHINI RENAL BIOPSY NEEDLE



PILE SYRINGE NEEDLE STRAIGHT



PILE SYRINGE NEEDLE CURVED



**SPONGE
HOLDING FORCEPS**
6"
8"
10"



**OVEM FORCEPS
STRAIGHT**



**OVEM FORCEPS
CURVED**



**UTERINE VULSELLUM
FORCEPS**



UTERINE TENACULUM
SINGLE TOOTH FORCEPS



UTERINE TENACULUM
DOUBLE TEETH FORCEPS



UTERINE ELEVATING
FORCEPS



UTERINE DRESSING
FORCEPS



**COLLIN UTERINE
ELEVATING FORCEPS**



**INTERIOR VAGINAL
WALL RETRACTOR**



**GRADUATED
UTERINE SOUND**



**RANDALLS
ENDOMETRIAL
BIOPSY CURETTE**



**ENDOMETRIAL
BIOPSY CURETTE NOVAK**

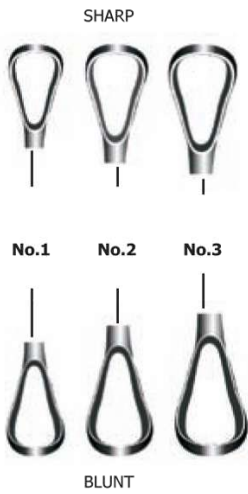

UTERINE CURETTES
DOUBLE SHARP - BLUNT



SIMS UTERINE CURETTES



SIMS SPECULUM
SMALL
MEDIUM
LARGE



SIMS SPECULUM
WITH FIBER OPTIC
LIGHT CARRIER



**CUSCO VAGINAL
SPECULUM
SMALL
MEDIUM
LARGE**



**CUSCO VAGINAL SPECULUM
WITH FIBER OPTIC LIGHT CARRIER
SMALL
MEDIUM
LARGE**



**CUSCO VAGINAL
SPECULUM GRAVE
SMALL
MEDIUM
LARGE**



**KRISTELLER VAGINAL
SPECULUM
SMALL
MEDIUM
LARGE**



**MARTIN
PELVIMETERS**



**HEGAR DILATORS
SET OF 8**



**HEGAR DILATORS
GRADUATED FINE 1/2MM
SET OF 10**



**HEGAR DILATORS
SINGLE ENDED
SET OF 16**





SURGICAL CRYO
WITH ONE PROBE



PERFORATOR
SIMS FORCEPS



POOL SUCTION
CANNULA



HYSTO-GRAPHI CANNULAS
WITH OUT LOCK SET OF 3



SMALL



MEDIUM



LARGE



HYSTO-GRAPHI CANNULAS
WITH LOCK SET OF 3



SMALL



MEDIUM



LARGE



**UTERINE
MANIPULATOR**



**YANKAUER TONSIL
SUCTION TUBE**



**UTERINE MANIPULATOR
RING HANDLE**



**UTERINE MANIPULATOR
RING HANDLE
DOUBLE ACTION**



**FOETAL
STETHOSCOPE**



FEMALE CATHETER



MYMO-SCREW



M.T.P. CANNULA METAL SET OF 6



EPISIOTOMY SCISSORS



UMBILICAL CORD SCISSORS

**CERVICAL BIOPSY PUNCH
FORCEPS
VAN DOREN**



**BIOPSY PUNCH FORCEPS
ALEXAI**



**MIDWIFERY FORCEPS
SIMPSON**



**WRINGLE
FORCEPS**

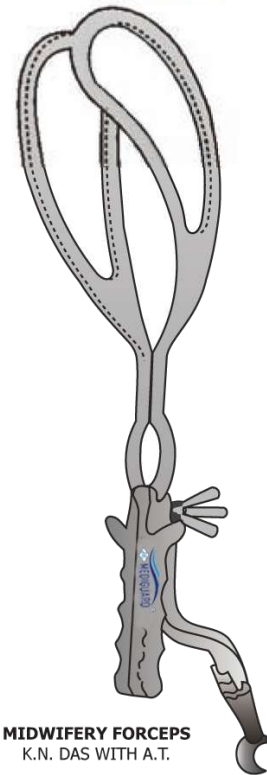

**MIDWIFERY FORCEPS
K.N. DAS WITH A.T.**



**GILLIES
CHISEL**



**GILLIES
GOUGE**



**GILLIES
OSTEOTOME**

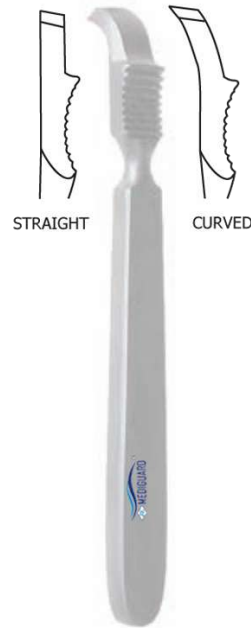

**FARABEU
ELEVATOR**



**MALLET
HEAVY DUTY**



**LISTEN BONE CUTTER
STRAIGHT**



**LISTEN BONE CUTTER
STRAIGHT
TUNGSTEN CARBIDE**



**LISTEN BONE CUTTER
CURVED**



**LISTEN BONE CUTTER
CURVED
TUNGSTEN CARBIDE**



STRAIGHT 8"



BONE RONGEUR

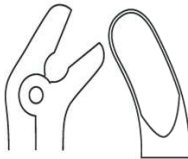

CURVED 8"



STILLE RUSKIN BONE RONGEUR



5MM



3MM



HENNINGS PLASTER SPREADER



GIGLE SAW HANDLES PAIR



GIGLE SAW WIRE



STILLE PLASTER SHEARS HANDLES



**AMPUTATION
SAW**



**PLASTER
SAW ANGLE**



**PLASTER
SAW BIG**



**TOURNIQUET WITH PUMPS
ALONG WITH 3 CUPS
COVERED WITH CLOTH BAG**



MICRO BONE DRILL



**UNIVERSAL
HAND DRILL**



**DOYAN RIB RASPATORIES
RIGHT - LEFT**



GIERTZ STILLE
RIB SHEARS



DOYAN
RIB SHEARS



HAIGHT FINOCHIETTO
RIB SPREADER
MEDIUM



FINOCHIETTO BURFORD
RIB SPREADER WITH 6 BLADES



FINOCHIETTO
RIB SPREADER
CHILD

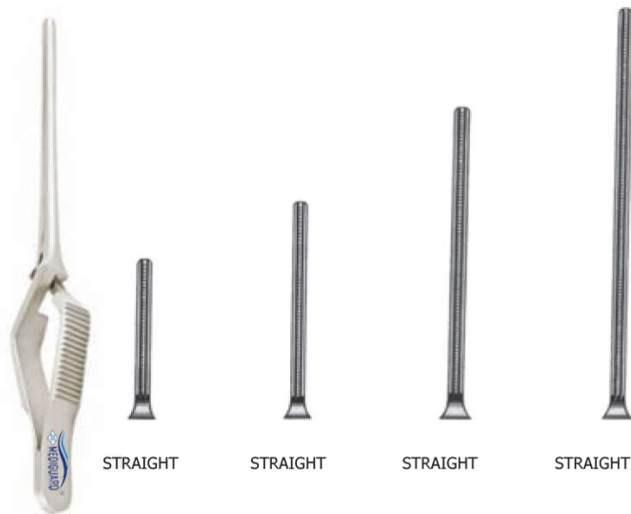

DeBAKEY
BULL-DOG CLAMPS
STRAIGHT



DeBAKEY VASCULAR
TISSUE FORCEPS



DeBAKEY
BULL-DOG CLAMPS
CURVED

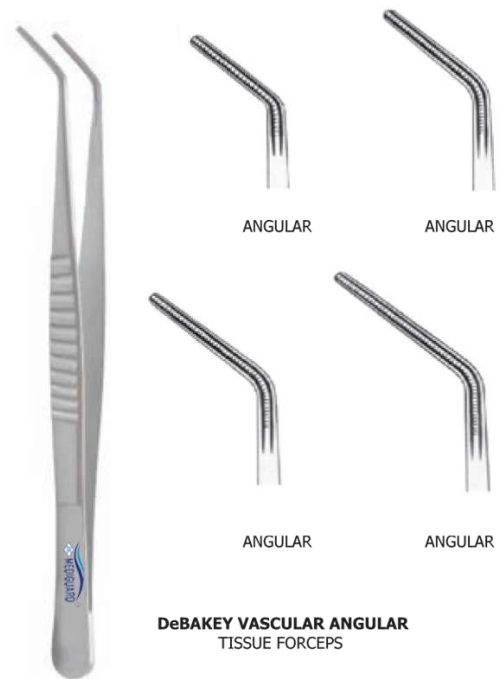

DeBAKEY VASCULAR ANGULAR
TISSUE FORCEPS



**ALLISON LUNG
RETRACTOR**



**RIB SPREADERS
APPROXIMATOR**



TUBING CLAMP



**COOLEY BACK
VESSEL CLAMPS**

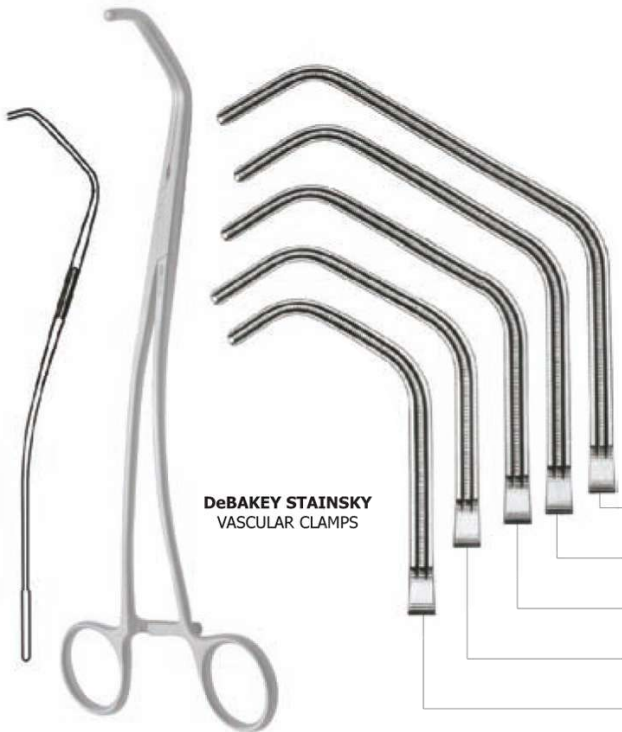

**DeBAKEY STAINSKY
VASCULAR CLAMPS**



**DeBAKEY STAINSKY
VASCULAR CLAMPS
TITANIUM**

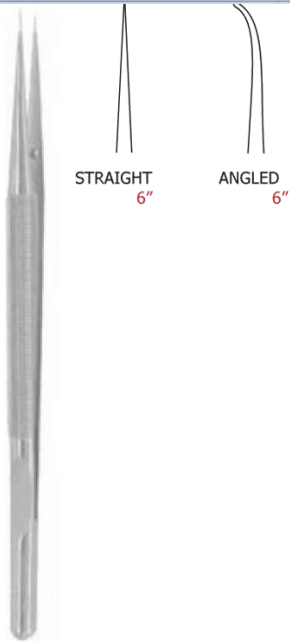

**MICRO FORCEPS
ROUND**



**MICRO FORCEPS
PLAIN
STAINLESS STEEL**

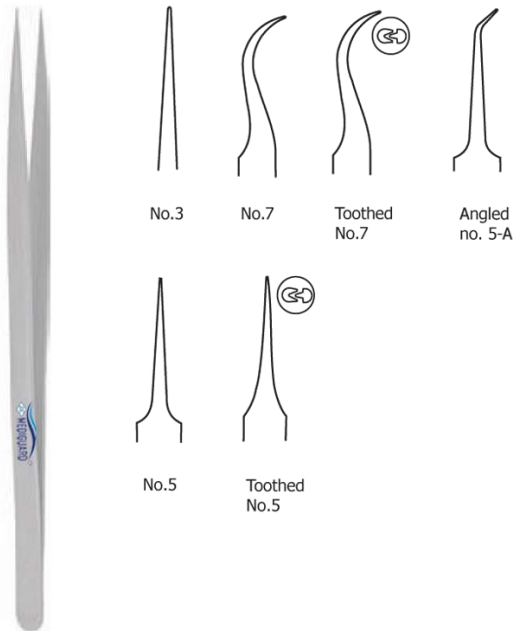

**JEWELLERS MICRO
FORCEPS NO. 3**

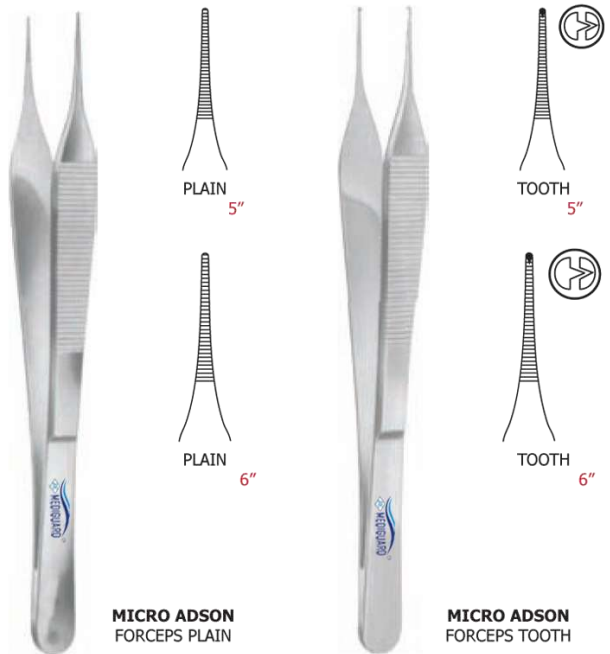

**MICRO ADSON
FORCEPS PLAIN**

**MICRO ADSON
FORCEPS TOOTH**



ADSON FORCEPS
PLAIN
STAINLESS STEEL



ADSON FORCEPS
1x2 TOOTH
STAINLESS STEEL



MICRO SPRING
NEEDLE HOLDER
ROUND WITH LOCK
CURVED
STAINLESS STEEL



MICRO SPRING
NEEDLE HOLDER
ROUND WITH LOCK
STRAIGHT



MICRO SPRING
NEEDLE HOLDER
ROUND WITHOUT LOCK
CURVED
STAINLESS STEEL



MICRO SPRING
NEEDLE HOLDER
ROUND WITHOUT LOCK
STRAIGHT



**MICRO SPRING
NEEDLE HOLDERS FLAT
WITHOUT LOCK STRAIGHT
STAINLESS STEEL**



**MICRO SPRING
NEEDLE HOLDERS FLAT
WITH OUT LOCK CURVED
STAINLESS STEEL**



**MICRO SPRING
NEEDLE HOLDERS FLAT
WITH LOCK STRAIGHT
STAINLESS STEEL**



**MICRO SPRING
NEEDLE HOLDERS FLAT
WITH LOCK CURVED
STAINLESS STEEL**



MICRO NEEDLE HOLDER
BAYONET TYPE
STRAIGHT
STAINLESS STEEL



MICRO NEEDLE HOLDER
BAYONET TYPE CURVED
STAINLESS STEEL



MICRO SPRING SCISSORS
BAYONET TYPE
STRAIGHT
STAINLESS STEEL



MICRO SPRING SCISSORS
BAYONET TYPE
CURVED
STAINLESS STEEL



MICRO SPRING SCISSORS
FLAT STRAIGHT
STAINLESS STEEL



MICRO SPRING SCISSORS
FLAT CURVED
STAINLESS STEEL



MICRO SPRING SCISSORS
ROUND STRAIGHT
STAINLESS STEEL



MICRO SPRING SCISSORS
ROUND CURVED
STAINLESS STEEL



**FIBER OPTIC
FLEXIBLE LARYNGOSCOPE
SET OF 3**



**FIBER OPTIC LARYNGOSCOPE
SET OF 3**



**MAGILL LARYNGOSCOPE
WITH BLADES**
SET OF 2 BLADES
SET OF 3 BLADES
SET OF 4 BLADES



LAMP FOR LARYNGOSCOPE



**McINTOSH LARYNGOSCOPE
WITH BLADES**
SET OF 3 BLADES
SET OF 4 BLADES



SPUTUM CUP
STAINLESS STEEL



SWAB BOX
STAINLESS STEEL



BOWL
STAINLESS STEEL



BED PANS
STAINLESS STEEL
MALE
FEMALE



BASINS
STAINLESS STEEL



DRESSING DRUMS
HEAVY DUTY STAINLESS STEEL



PORTABLE SINGLE DRUM
AUTOCLAVE HEAVY DUTY
STAINLESS STEEL



**INSTRUMENTS STERILIZING
PERFORATOR BOX
STAINLESS STEEL**

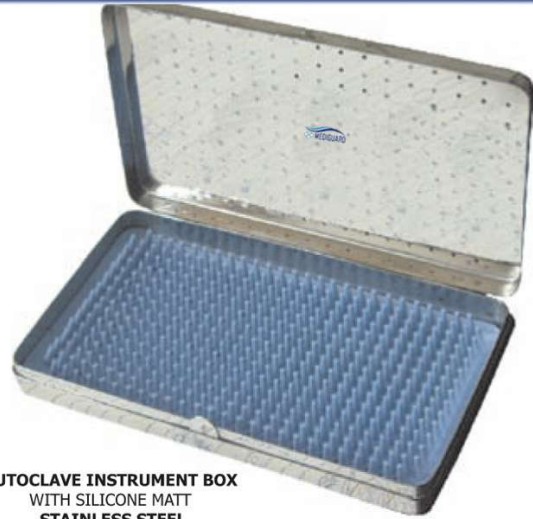

**AUTOClave INSTRUMENT BOX
WITH SILICONE MATT
STAINLESS STEEL**



**CIDEX BOX HEAVY
STAINLESS STEEL**



**SURGICAL TRAY WITH LID
HEAVY STAINLESS STEEL**



**KIDNEY TRAY
HEAVY
STAINLESS STEEL**

FIBER OPTIC HEAD LIGHT BAND



SURGICAL HANDLE

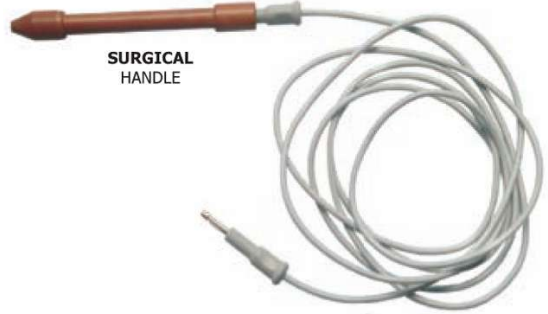

FIBER OPTIC CABLE
3.5 mm length 2
4.5 mm length 2.



FOOT PADDLE



ULTRA COMPACT XENON LIGHT SOURCE 300W



SURGICAL PATIENT PLATE



FIBER OPTIC COLD LIGHT SOURCE
DOUBLE POINT 24 V - 250 W



FIBER OPTIC COLD LIGHT SOURCE
SINGLE POINT 15 V - 150 W



MICRO SPRING SCISSORS
ANGLED
STAINLESS STEEL
6"



SURGICAL ELECTRODE
WIRE LOOP



BREATHING BAG
PEDIATRIC
SILICONE



BREATHING BAG
CHILD
SILICONE



BREATHING BAG
ADULT
SILICONE



**SUCTION MACHINE
HI - VAC**



**SUCTION MACHINE
JUNIOR HI - VAC 3.0 LTRS**



**SUCTION MACHINE
EP-90 ELECTRIC CUM MANUAL**



**EUROVAC ELECTRIC
SUCTION MACHINE**



**NON TIRING MANUAL
POWERED SUCTION**



**SILICONE VENTEUSE CUP
SMALL - LARGE
(VACCUM CUPS)**

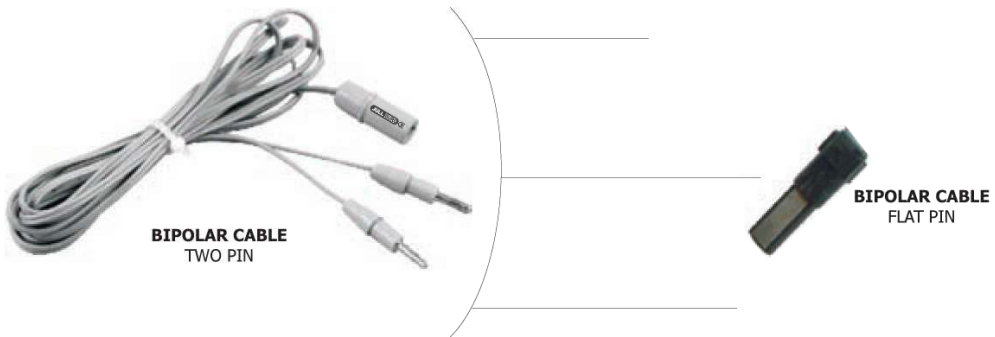

THE MARK OF QUALITY & CRAFTSMANSHIP



**OBSTETRICAL
&
GYNECOLOGY
SURGICAL
INSTRUMENTS**

**The House Known For
Surgical Instruments**



JULLUNDUR ENTERPRISES

Manufacturer & Exporter Of Surgical Instruments



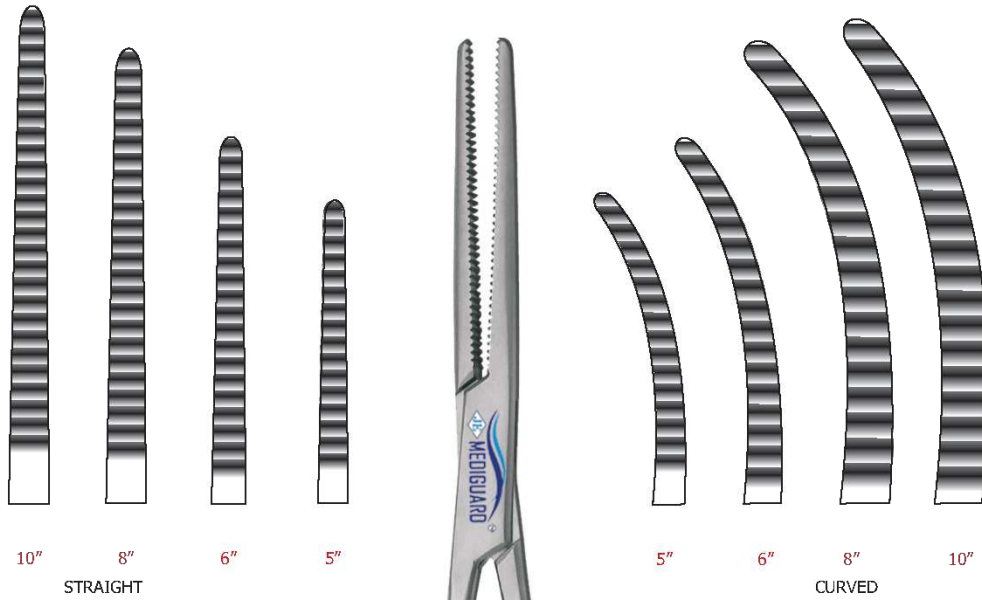

SPENCER WELLS ARTERY FORCEPS

STRAIGHT

- 5"
- 6"
- 8"
- 10"

CURVED

- 5"
- 6"
- 8"
- 10"

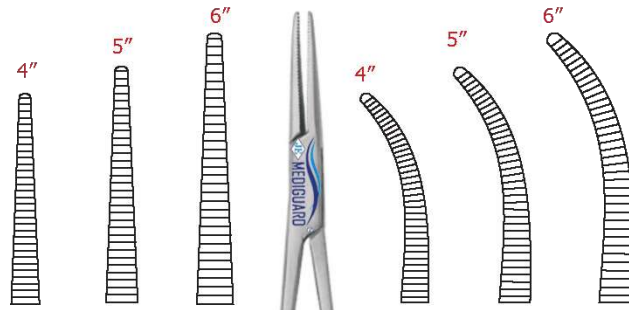

STRAIGHT

CURVED

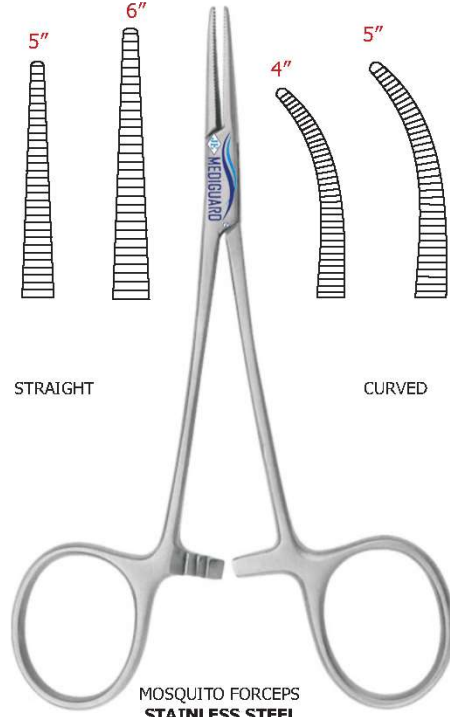

**MOSQUITO FORCEPS
STAINLESS STEEL**

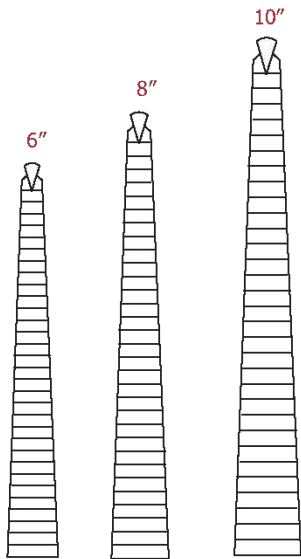

STRAIGHT



**KOCHER'S
ARTERY FORCEPS
STRAIGHT**



**KOCHER'S
ARTERY FORCEPS
CURVED**

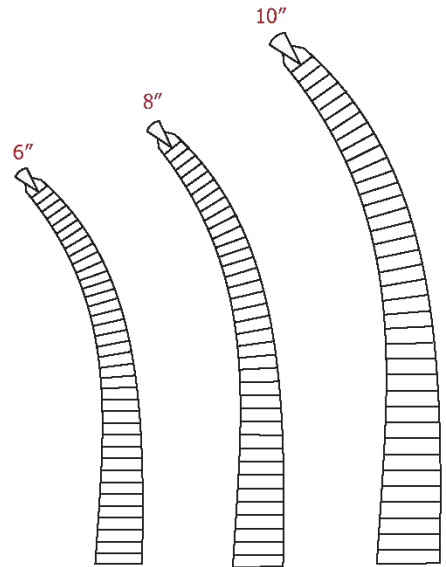

CURVED

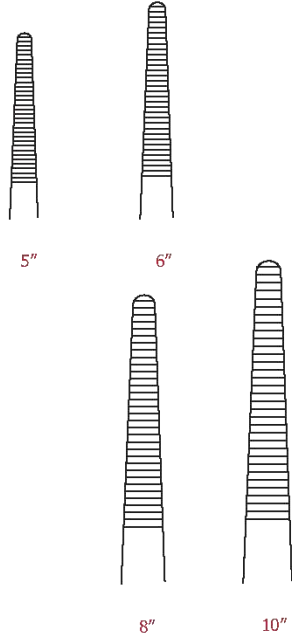

DISSECTING FORCEPS
STAINLESS STEEL - PLAIN

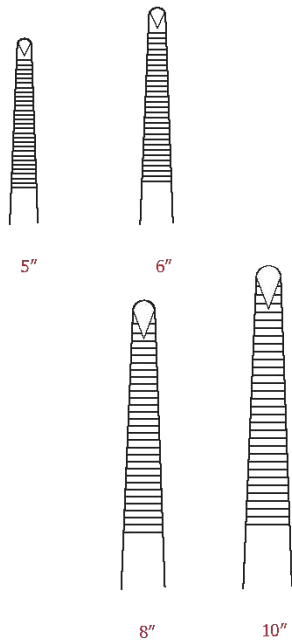

DISSECTING FORCEPS
STAINLESS STEEL - TOOTH



PBIUCD KELLY FORCEPS
STAINLESS STEEL

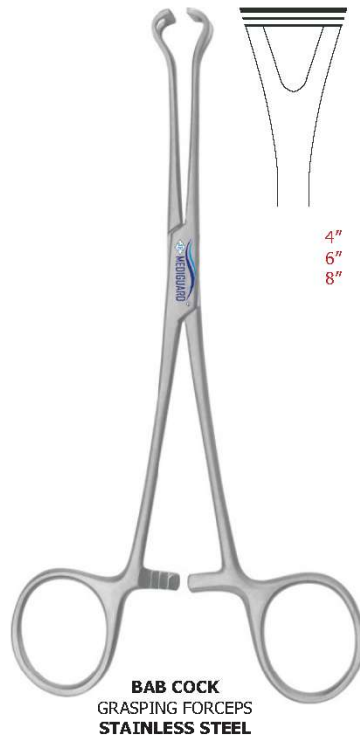



TOWEL CLIP
CROSS-ACTION



B.P. HANDLE NO. 3



B.P. HANDLE NO. 4



10



11



12



15



20



21



22



23



24

BARD PARKER BLADES
No. 10, 11, 12, 15, 20, 21, 22, 23, 24

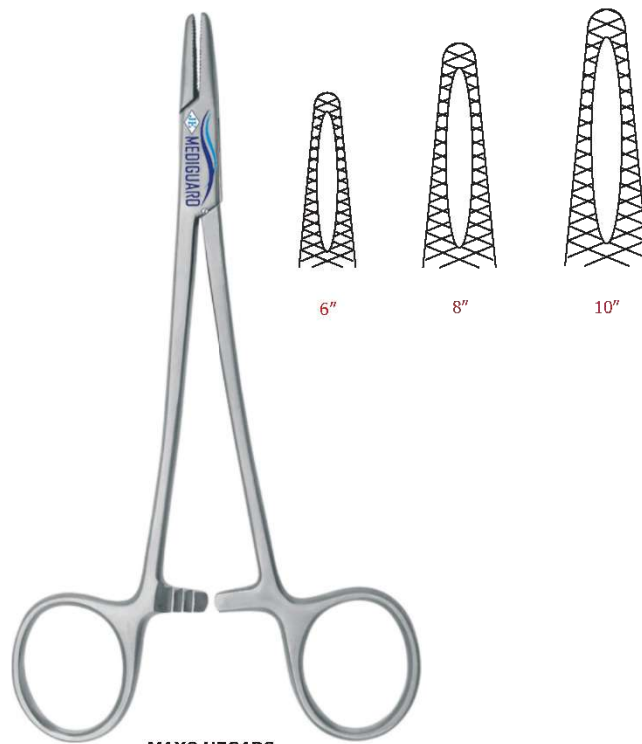

**MAYO HEGARS
NEEDLE HOLDERS
STRAIGHT
STAINLESS STEEL**

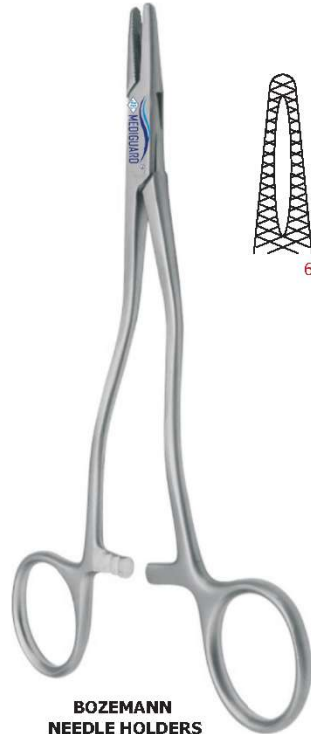

**BOZEMANN
NEEDLE HOLDERS
STRAIGHT
STAINLESS STEEL**

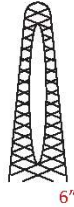

6"

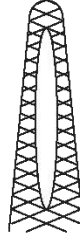

8"



**DRESSING SCISSORS
STRAIGHT (SHARP x BLUNT)
STAINLESS STEEL**



**DRESSING SCISSORS
CURVED (SHARP x BLUNT)
STAINLESS STEEL**



**IRIS SCISSORS
STRAIGHT
STAINLESS STEEL**



**IRIS SCISSORS
CURVED
STAINLESS STEEL**

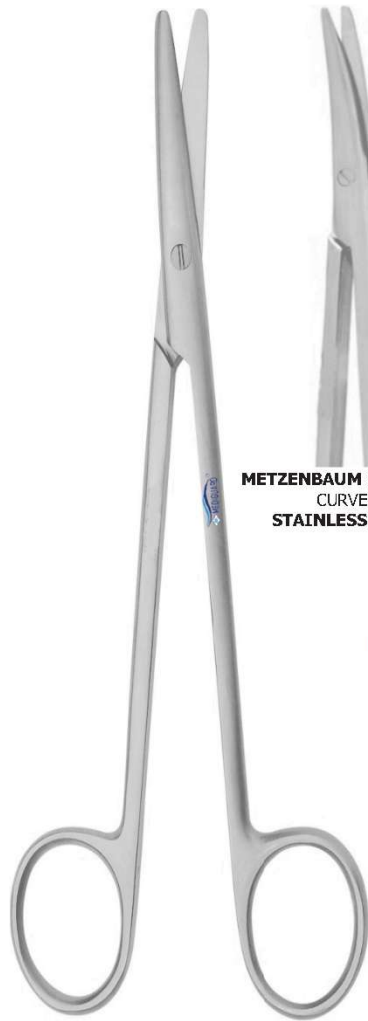

METZENBAUM SCISSORS
CURVED
STAINLESS STEEL

6"
8"
10"

METZENBAUM SCISSORS
STRAIGHT
STAINLESS STEEL

6"
8"
10"



**MAYO SCISSORS
CURVED
STAINLESS STEEL**

- 6
- 8
- 10

**MAYO SCISSORS
STRAIGHT
STAINLESS STEEL**

- 6
- 8
- 10



**HEATH SUTURE
REMOVAL SCISSORS**



**LISTRE BANDAGE
CUTTING SCISSORS**
5½"
7½"



**UMBILICAL CORD
SCISSORS**



**EPISIOTOMY
SCISSORS**



HYSTERECTOMY
MAINGOTS FORCEPS
STRAIGHT



HYSTERECTOMY
MAINGOTS FORCEPS
CURVED



HYSTERECTOMY
DeBAKEY FORCEPS



HYSTERECTOMY
DeBAKEY CLAMP
STRAIGHT



HYSTERECTOMY
DeBAKEY CLAMP
CURVED



HEANYS HYSTERECTOMY
FORCEPS SINGLE TOOTH
STRAIGHT



HEANYS HYSTERECTOMY
FORCEPS SINGLE TOOTH
CURVED



HEANYS
HYSTERECTOMY
FORCEPS DOUBLE TEETH
STRAIGHT



HEANYS HYSTERECTOMY
FORCEPS DOUBLE TEETH
CURVED



CZERNY RETRACTOR
6"
8"

**LANGENBECK
RETRACTOR
SMALL**



**LANGENBECK
RETRACTOR
LARGE**



**LANGENBECK RETRACTOR
WITH FIBER OPTIC LIGHT CARRIERS
ALONG WITH SUCTION**

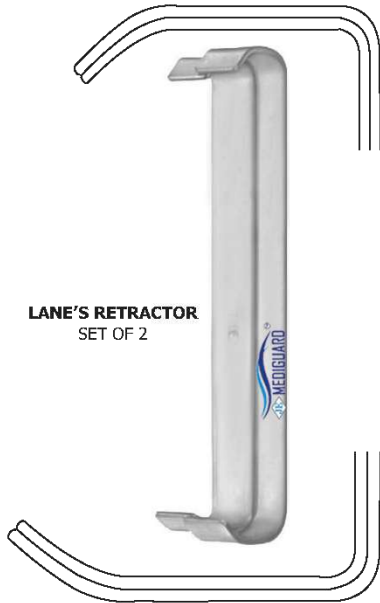

LANE'S RETRACTOR
SET OF 2

ROUX RETRACTOR
SET OF 3



**LONDON
VAGINAL RETRACTOR
RIGHT ANGLED**





**DEAVERS
RETRACTOR**



**DEAVERS RETRACTOR
ADULT**



**DEAVERS RETRACTOR
WITH FIBER OPTIC LIGHT CARRIER
ADULT**



CHEATLE JAR



**CHEATLE
FORCEPS
10"**



**MAYO SAFETY PIN
INSTRUMENT HOLDER**

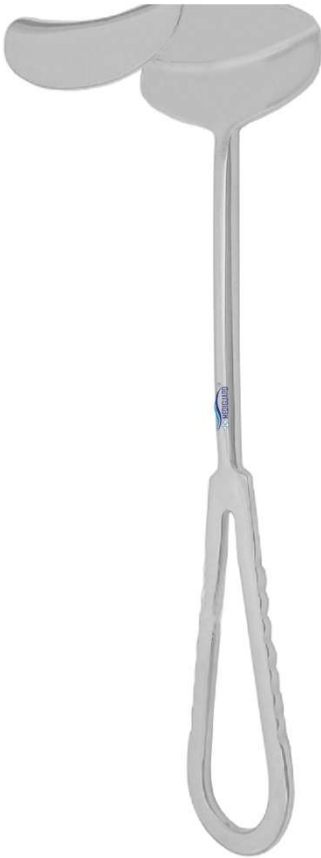

MORRIS RETRACTOR



**MORRIS RETRACTOR
WITH FIBER OPTIC
LIGHT CARRIER**



DOYEN RETRACTOR



**DOYEN RETRACTOR
WITH FIBER OPTIC
LIGHT CARRIERS**

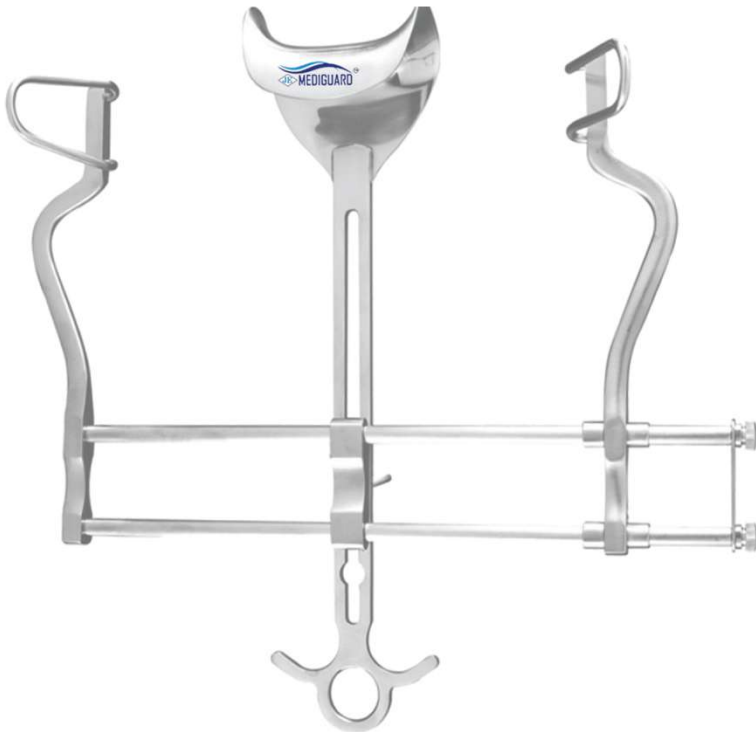

**(BALFOUR) ABDOMINAL
SELF - RETAINING RETRACTOR**



**POZZI SELF-RETAINING RETRACTOR
WITH THREE BLADE**



**(BALFOUR) ABDOMINAL
SELF - RETAINING RETRACTOR
CHILD**



**SPONGE
HOLDING FORCEPS**



**OVEM FORCEPS
STRAIGHT**



**OVEM FORCEPS
CURVED**



**UTERINE VULSELLUM
FORCEPS**



**UTERINE TENACULUM
SINGLE TOOTH FORCEPS**



**UTERINE TENACULUM
DOUBLE TEETH FORCEPS**



**UTERINE ELEVATING
FORCEPS**



**UTERINE DRESSING
FORCEPS**



**COLLIN UTERINE
ELEVATING FORCEPS**



**INTERIOR VAGINAL
WALL RETRACTOR**



**GRADUATED
UTERINE SOUND**



**RANDALLS
ENDOMETRIAL
BIOPSY CURETTE**



**ENDOMETRIAL
BIOPSY CURETTE NOVAK**



IUD HOOK

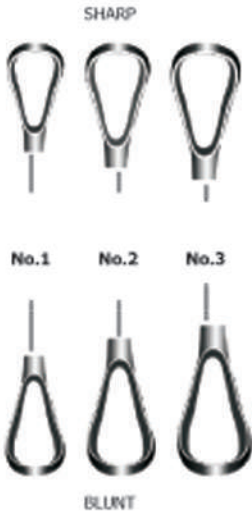

**UTERINE CURETTES
DOUBLE SHARP - BLUNT**



**SIMS UTERINE
CURETTES**



**SIMS SPECULUM
SMALL
MEDIUM
LARGE**



**BREATHING BAG
PEDIATRIC
SILICONE**



**BREATHING BAG
CHILD
SILICONE**



**BREATHING BAG
ADULT
SILICONE**



**SIMS SPECULUM
WITH FIBER OPTIC
LIGHT CARRIER**



**CUSCO VAGINAL
SPECULUM
SMALL
MEDIUM
LARGE**



**CUSCO VAGINAL SPECULUM
WITH FIBER OPTIC LIGHT CARRIER
SMALL
MEDIUM
LARGE**



**CUSCO VAGINAL
SPECULUM GRAVE
SMALL
MEDIUM
LARGE**



**KRISTELLER VAGINAL
SPECULUM
SMALL
MEDIUM
LARGE**



**MARTIN
PELVIMETERS**



**HEGAR DILATORS
SET OF 8**



**HEGAR DILATORS
GRADUATED FINE 1/2MM
SET OF 10**



**HEGAR DILATORS
SINGLE ENDED
SET OF 16**



**SURGICAL CRYO
WITH ONE PROBE**



**PERFORATOR
SIMS FORCEPS**



**POOL SUCTION
CANNULA**



**HYSTO-GRAPHI CANNULAS
WITH OUT LOCK SET OF 3**



SMALL



MEDIUM



LARGE



**HYSTO-GRAPHI CANNULAS
WITH LOCK SET OF 3**



SMALL



MEDIUM



LARGE



**UTERINE
MANIPULATOR**



**YANKAUER TONSIL
SUCTION TUBE**



**FEMALE
CATHETER**



**UTERINE MANIPULATOR
RING HANDLE**



**UTERINE MANIPULATOR
RING HANDLE
DOUBLE ACTION**



**MIDWIFERY FORCEPS
SIMPSON**



**WRINGLE
FORCEPS**



**M.T.P. CANNULA METAL
SET OF 6**

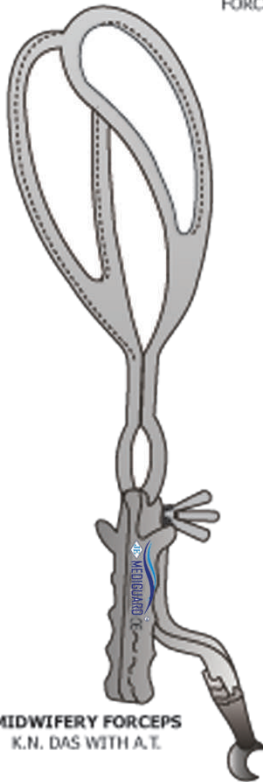

**MIDWIFERY FORCEPS
K.N. DAS WITH A.T.**



MYMO-SCREW



**FOETAL
STETHOSCOPE**

**CERVICAL BIOPSY PUNCH
FORCEPS
VAN DOREN**

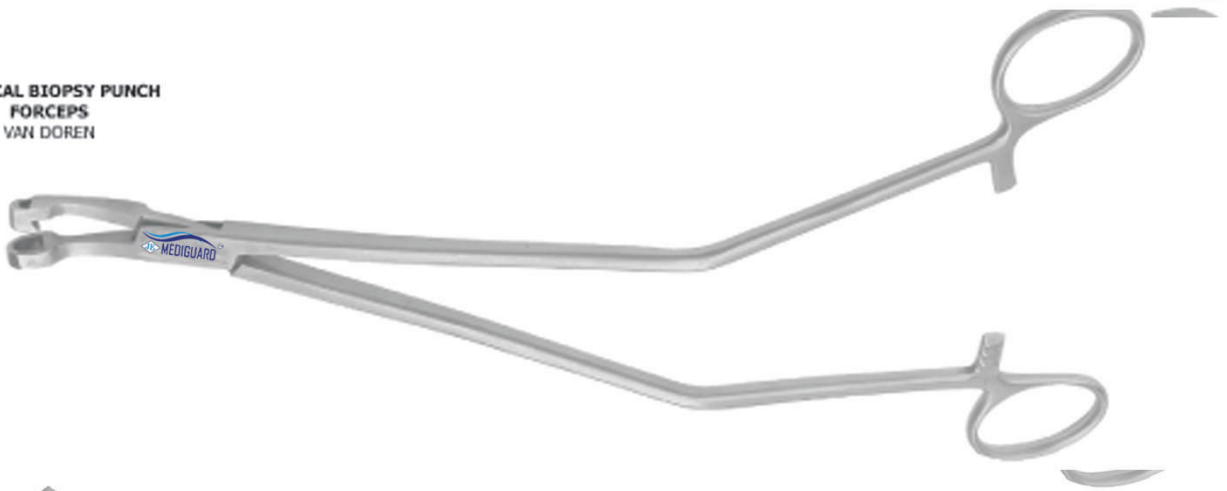

**BIOPSY PUNCH FORCEPS
ALEXAI**

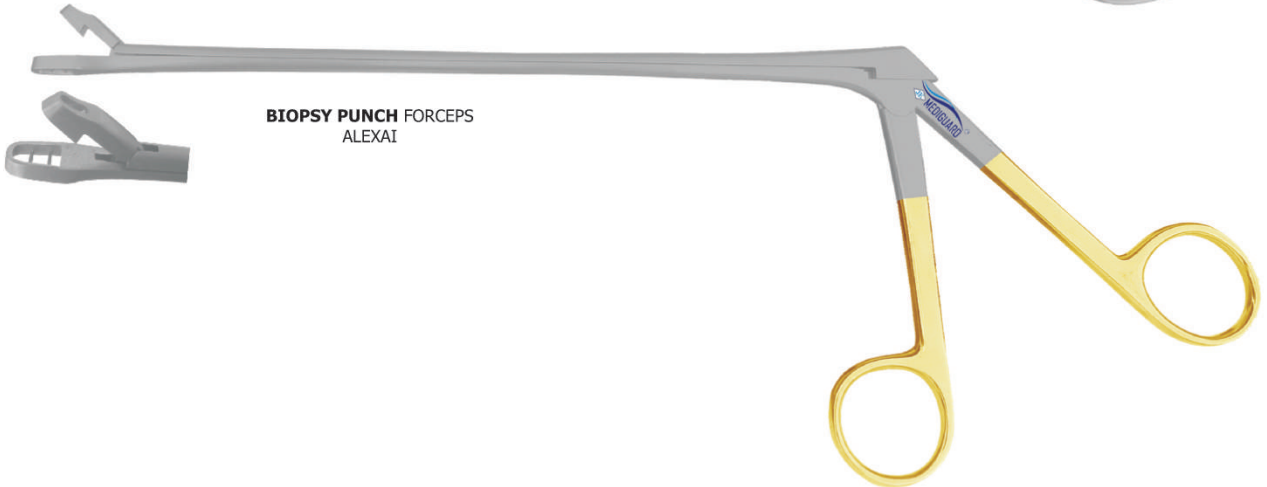

**TISCHLER
BIOPSY FORCEPS**



FIBER OPTIC HEAD LIGHT BAND



SURGICAL HANDLE



BIPOLAR CABLE TWO PIN

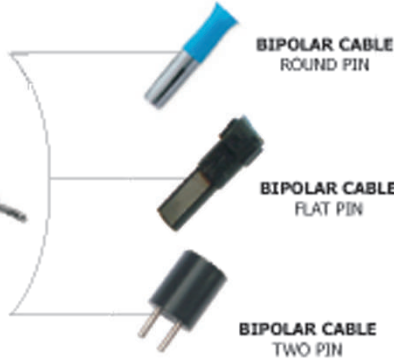

BIPOLAR CABLE ROUND PIN

BIPOLAR CABLE FLAT PIN

BIPOLAR CABLE TWO PIN



FIBER OPTIC CABLE
3.5 mm length 230 cm



SURGICAL PATIENT PLATE



FIBER OPTIC COLD LIGHT SOURCE
SINGLE POINT 15 V - 150 W



FIBER OPTIC COLD LIGHT SOURCE
DOUBLE POINT 24 V - 250 W



**BIPOLAR COAGULATION FORCEP
BAYONET TYPE
WITH TWO PIN STRAIGHT**



**BIPOLAR COAGULATION FORCEP
BAYONET TYPE
WITH FLAT PIN STRAIGHT**



**BIPOLAR COAGULATION FORCEP
BAYONET TYPE
WITH SUCTION STRAIGHT**



**BIPOLAR COAGULATION FORCEP
BAYONET TYPE
WITH IRRIGATION STRAIGHT**



**BIPOLAR COAGULATION
FORCEP CURVED
WITH TWO PIN**



**BIPOLAR COAGULATION
FORCEP CURVED
WITH FLAT PIN**



**BIPOLAR COAGULATION
FORCEPS STRAIGHT
WITH TWO PINS**



**BIPOLAR COAGULATION
FORCEPS STRAIGHT
WITH FLAT PINS**



**BIPOLAR COAGULATION
FORCEPS STRAIGHT
WITH IRRIGATION**



ARTERY FORCEPS
STRAIGHT
7"



ARTERY FORCEPS
CURVED
7"



TURNER WARWICK SCISSORS
STRAIGHT
7"



TURNER WARWICK SCISSORS
CURVED



PEDERSON VAGINAL SPECULUM
WITH SMOKE EVACUATION TUBE
SMALL
MEDIUM
LARGE



GREAVES VAGINAL SPECULUM
WITH SMOKE EVACUATION TUBE
SMALL
MEDIUM
LARGE



SURGICAL ELECTRODE
NEEDLE TYPE



SURGICAL ELECTRODE
WIRE LOOP



SURGICAL ELECTRODE
KNIFE TYPE



SURGICAL ELECTRODE
ANGLE TYPE



SURGICAL ELECTRODE
BALL TYPE



**KOGAN ENDOCERVICAL
SPECULUM**



**LATERAL VAGINAL
RETRACTOR**



**GELPI RETRACTOR
BIPOLAR**



**RIGBY RETRACTOR
BIPOLAR**



**LATERAL RETRACTOR
WIDE OPEN**



**RING FORCEP
BIPOLAR**



**SINGLE TOOTH
TENACULUM
BIPOLAR**



**EMMET HOOK
BIPOLAR**



**THREE PRONG
HOOK
BIPOLAR**



**HOOK 12CM
BIPOLAR**



**DAGGER 18CM
BIPOLAR**



SUCTION MACHINE
HI - VAC 4.5 LTRS
(50x38x70)CMS



SUCTION MACHINE
JUNIOR HI - VAC 3.0 LTRS
(39x33x65)CMS



SUCTION MACHINE
EP-90 ELECTRIC CUM MANUAL



EUROVAC ELECTRIC
SUCTION MACHINE



NON TIRING MANUAL
POWERED SUCTION



SILICONE VENTEUSE CUP
SMALL - LARGE
(VACCUUM CUPS)





MICRO TUBOPLASTY INSTRUMENT SET

- | | |
|---|---|
| <ol style="list-style-type: none"> 1. ABDOMINAL RETRACTOR KIRSHNER SET OF 4 BLADES 2. MICRO JEWELER FORCEPS NO. 3 3. MICRO JEWELER FORCEPS NO. 7 4. MICRO JEWELER FORCEPS NO. 5 5. MICRO ADSON FORCEPS PLAIN 5" 6. MICRO ADSON FORCEPS TOOTH 5" 7. MICRO SPRING NEEDLE HOLDERS FLAT WITHOUT LOCK STRAIGHT 6" 8. MICRO SPRING NEEDLE HOLDERS FLAT WITHOUT LOCK CURVED 6" 9. MICRO SPRING SCISSORS ROUND STRAIGHT 6" 10. MICRO SPRING SCISSORS ROUND CURVED 6" 11. KILNER NEEDLE HOLDERS FINE STRAIGHT 5" 12. BIPOLAR COAGULATION FORCEPS CURVED 8" 13. BIPOLAR COAGULATION FORCEPS BAYONET TYPE 8" 14. DeBAKEY BULL-DOG CLAMPS STRAIGHT 2" | <ol style="list-style-type: none"> DISSECTING PROBE 75° ANGLED MALLEABLE PROBE WITH EYE 5" PROBE CURVED DISSECTOR GILLIES SUCTION TUBE WITH VALVE |
|---|---|

THE MARK OF QUALITY & CRAFTSMANSHIP



**ENT
SURGICAL
INSTRUMENTS**

**The House Known For
Surgical Instruments**



JULLUNDUR ENTERPRISES

Manufacturer & Exporter Of Surgical Instruments





SIZE IN mm Ø

GRUBER
AURAL SPECULUM



SIZE IN mm Ø

HARTMANN - BLACK
AURAL SPECULUM



SIZE IN mm Ø

HARTMANN
AURAL SPECULUM



SIZE IN mm Ø

HEATH
AURAL SPECULUM
OVAL SHAPE



HOLMGREN
SELF RETAINING
AURAL SPECULUM



ROSEN
AURAL SPECULUM
SET OF 4



SHEA
AURAL SPECULUM
SET OF 4

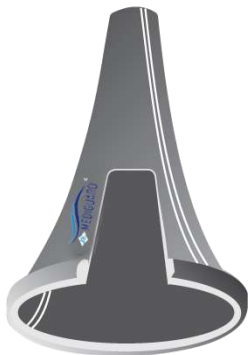

ROSEN
AURAL SLOTTED
SPECULUM
SET OF 4



TUMARKIN TAPERED
SLOTTED AURAL
SPECULUM
SET OF 4



OTOENDO
SCOPE



SIZE IN mm Ø

- 4
- 5
- 6

SIEGLE PNEUMATIC
SPECULUM SET OF 3



128 HZ
256 HZ
512 HZ
1024 HZ
2048 HZ
4096 HZ

HARTMANN
TUNING FORKS



EUSTACHIAN
CATHETER

2.3 MM
3.3 MM
4.3 MM



FORMBY
CERUMEN
SCOOP & HOOK



16.5 CM
CHILD



19 CM
ADULT

JOBSON
HORNE
PROBES



HOVELL
WAX LOOP



FOREIGN
BODY REMOVING



FOREIGN BODY
& HARD WAX REMOVING



RING
CURETTE
BUCK



SMALL



LARGE



WAGNER HOOK
DELICATE

SIZE
2 MM

SIZE
3 MM



WIRE
WAX REMOVER



**FAGGE AURAL
FORCEPS PLAIN
S.S**



**FAGGE AURAL
FORCEPS 1x2 TOOTH
S.S**



**WILDE AURAL
FORCEPS**



**ADSON FORCEPS
S.S**

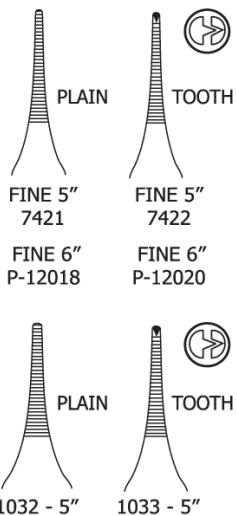

**ADSON BROWN
FORCEPS 5"**



**OSSICLE
HOLDING CLAMP**



**HARTMANN
AURAL FORCEPS**



**TILLEY
AURAL FORCEPS**



**LEMPERT
NIBBLING FORCEPS
STRAIGHT**



**LEMPERT
NIBBLING
FORCEPS**



**LEMPERT
NIBBLING FORCEPS
CURVED FINE**



**LEMPERT
ENDAURAL SPECULUM**



**AURAL SYRINGE
ALL METAL WITH
2 PIPES CONICAL**



PLESTER SELF
RETAINING RETRACTOR
2x2 PRONGS



WULLSTEIN SELF
RETAINING RETRACTOR
2x3 PRONGS



WULLSTEIN SELF
RETAINING RETRACTOR
3x4 PRONGS



PLESTER SELF
RETAINING RETRACTOR
RIGHT SOLID BLADE



PLESTER SELF
RETAINING RETRACTOR
LEFT SOLID BLADE



WULLSTEIN SELF
RETAINING RETRACTOR
3x3 PRONGS



CONE SELF
RETAINING ADJUSTABLE
RETRACTOR



PLESTER JANSEN
RETRACTOR
RIGHT SOLID BLADE



PLESTER JANSEN
RETRACTOR
LEFT SOLID BLADE



JANSEN
RETRACTOR



LEMPERT
MASTOID CURETTE



JANSEN
CHISEL
140mm



JANSEN
OSTEOTOME
140mm



JENKINS
GOUGE
140mm

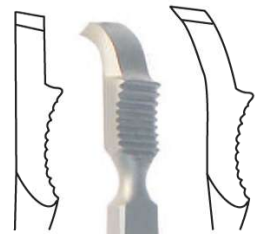

STRAIGHT

CURVED

FARABEUF
ELEVATOR



1mm

2mm

KERRISON PUNCH
UPWARD CUTTING



LAKE
SEEKER



HOUSES GRAFT
PRESS FORCEPS



TEMPORAL
BONE HOLDER



**BARRON SUCTION
TUBE**



**FRAZIER SUCTION
TUBES WITH LARGE HOLE,
FOR SUCTION CONTROL**



**LEMPERT MASTOID
SUCTION
TUBES**



**FRAZIER SUCTION
TUBES, BALL END**



**MICRO INSTRUMENTS RACK
FOR 12 MICRO POINTS**



**MICRO INSTRUMENTS TRAY
FOR FORCEPS & MICRO POINT
WITH SILICONE MAT**



**VERHOEVEN
SUCTION
TUBES ADAPTOR**



**VERHOEVEN SUCTION
TUBES**

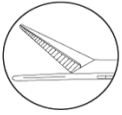

OFFICE (O.P.D.)
ALIGATOR

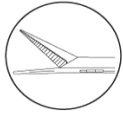

FINE STRAIGHT

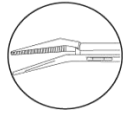

LEFT CURVED

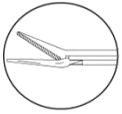

RIGHT CURVED

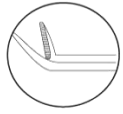

FINE UPWARD

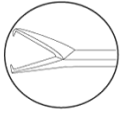

FINE 1x2 TEETH



FINE STRAIGHT



FINE LEFT
CURVED



FINE RIGHT
CURVED



FINE UPWARD



FINE STRAIGHT



LEFT CURVED



RIGHT CURVED



FINE UPWARD

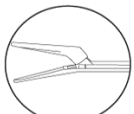

**MICRO AURAL CROCODILE
FORCEPS SERRATED**



**MICRO AURAL
CUP FORCEPS**



**MICRO AURAL
SCISSORS**



**MC GEE
WIRE CLOSING FORCEPS**

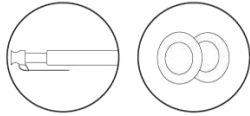

**GROMMET TUBE
INSERTER**

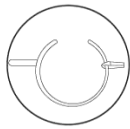

**TEFLON PISTON
HOLDING FORCEPS**



**MICRO AURAL POLYPUS
FORCEPS**

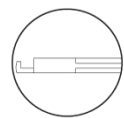

UP

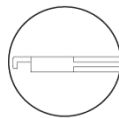

DOWN



**HOUSE DIETER
MALLEUS NIPPERS**

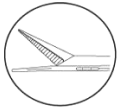

STRAIGHT
(O.P.D) OFFICE USE
BIG SIZE

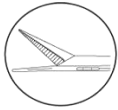

FINE STRAIGHT
3 MM

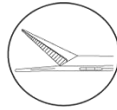

FINE STRAIGHT
5 MM

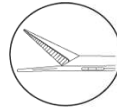

FINE STRAIGHT
7 MM

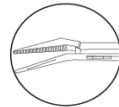

LEFT CURVED

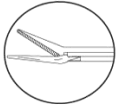

RIGHT CURVED

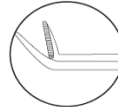

FINE UPWARD

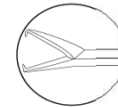

FINE 1x2 TEETH



**MICRO AURAL CROCODILE
FORCEPS SERRATED
EXTRA FINE**



FINE STRAIGHT



FINE LEFT CURVED



FINE RIGHT
CURVED



FINE UPWARD



**MICRO AURAL
CUP FORCEPS
EXTRA FINE**



FINE STRAIGHT



LEFT CURVED



RIGHT CURVED



FINE UPWARD



**MICRO AURAL
SCISSORS
EXTRA FINE**

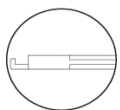

UP

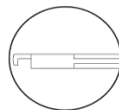

DOWN



**HOUSE DIETER
MALLEUS NIPPERS
EXTRA FINE**



**MICRO AURAL POLYPUS
FORCEPS**

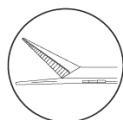
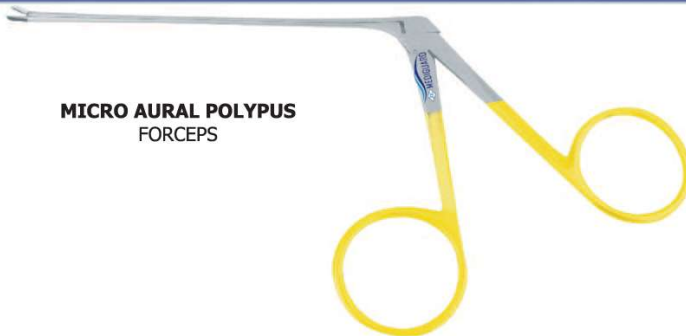

FINE STRAIGHT

**MICRO AURAL CROCODILE
FORCEPS SERRATED
TITANIUM**



FINE STRAIGHT

**MICRO AURAL
CUP FORCEPS
TITANIUM**



FINE STRAIGHT

**MICRO AURAL
SCISSORS
TITANIUM**



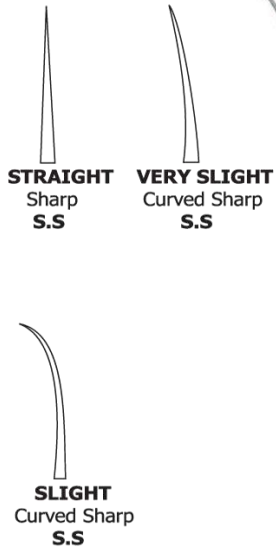

WULLSTEIN PICK NEEDLES



ANGLED WULLSTEIN NEEDLES



LARKIN PENETRATOR BURR



HOUSE MEASURING RODS

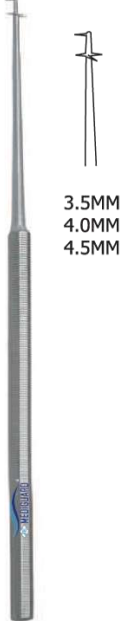

SHEA PISTON DEPTH GAUGE

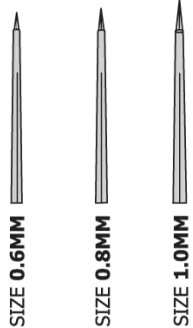

Dr. KIRTANE PERFORATOR WITH GUARD



MICRO HOOK-S.S



ANGLED MICRO HOOK UP



HOOK RIGHT HOOK LEFT



PLESTER FOOT PLATE HOOK (CROCIA)



MEASURING JIG



**ROSEN
ELEVATOR**



**ANGLED
ELEVATOR**



**BEALES
RASPATORY**



**FISCH
RASPATORY RIGHT**



**FISCH
RASPATORY LEFT**



**ROSEN
CURETTE**



**HOUSE CURETTE
DOUBLE ENDED**



**HOUSE CURETTE ANGLED
DOUBLE ENDED**



**ROSEN CURETTE
CURVED**



BALL PROBE

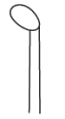

SMALL



MEDIUM



LARGE

**CIRCULAR CUTTING
KNIFE 60°**



**CIRCULAR CUTTING
KNIFE CURVED**



**CIRCULAR KNIFE
WITH HOLE**



**PLESTER
FIRST INCISION KNIFE**



**Dr. DHINGRA
SICKLE KNIFE
WITH SAW**



3mm



5mm



7mm

**SICKLE
KNIFE**



**ANGLED
SICKLE KNIFE DOWN**



**ANGLED
SICKLE KNIFE UP**



**MYRINGOTOMY
KNIFE**



Suction Micro Hook
45°



CIRCULAR KNIFE
45°, Suction



ELEVATOR
Suction



PLESTER
First Incision Knife, Suction



MYRINGOTOMY KNIFE
SUCTION



SICKLE KNIFE
SUCTION



Suction Micro Hook
45°



CIRCULAR KNIFE
45°, Suction



ELEVATOR
Suction



PLESTER
First Incision Knife, Suction



MYRINGOTOMY KNIFE
SUCTION



SICKLE KNIFE
SUCTION



STEEL CUTTING BURR
(STAINLESS STEEL)



TUNGSTEN CARBIDE CUTTING BURR
(T.C)

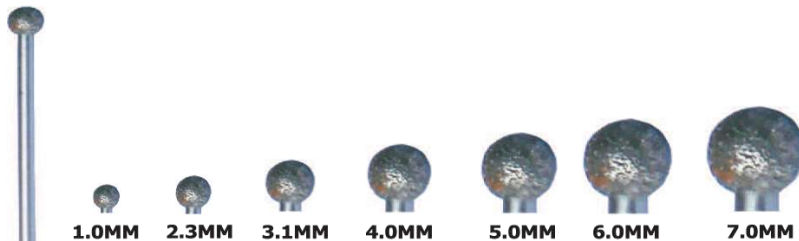

DIAMOND PASTE BURR

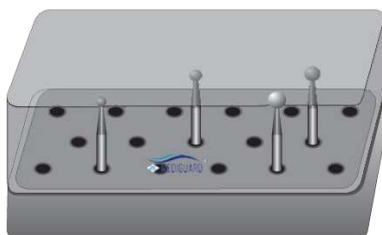

BURR STAND BLOCK



STEEL CUTTING BURR OVAL SHAPE
(STAINLESS STEEL)



KILLIAN NASAL SPECULUM
5CM, 6.5CM, 7.5CM, 9CM

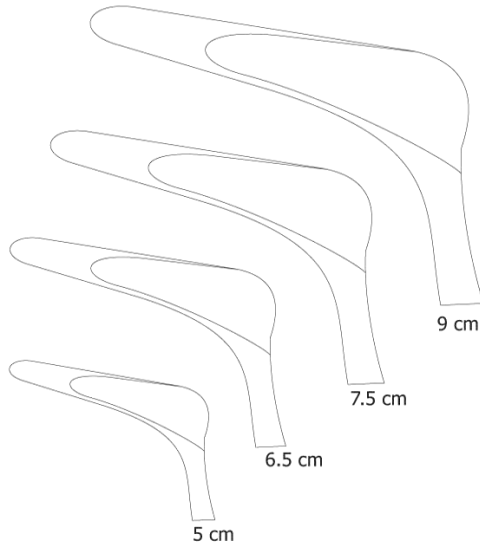

HARTMAN
NASAL SPECULUM



PEDIATRIC SPECULUM



ADULT SPECULUM



KILLIAN NASAL SPECULUM
WITH FIBER OPTIC LIGHT 7.5CM



THUDICHUM
NASAL SPECULUM SET OF 3



COTTLE COLUMELLA
FORCEPS



**COTTLE
RETRACTOR
BLUNT**



**COTTLE
RETRACTOR
SHARP**



**JOSEPH
RETRACTOR
FINE SHARP**



**GILLIES
SKIN HOOK**



**BALLENGER SWIVEL
KNIFE BAYONET**



**COTTLE UPPER
RETRACTOR**



**ALAR
RETRACTOR**



**KILNER
RETRACTOR**

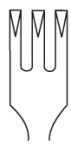

SHARP



BLUNT



**TILLEY SEPTUM
GOUGE V-SHAPE**

SIZE

4 MM
5 MM
6 MM



**KILLIAN
NASAL GOUGE**

SIZE

4 MM
5 MM
6 MM



**TILLEY LICHTWITZ
ANTRAL TROCAR &
CANNULA**



**ANTRAL WASH
RUBBER SYRINGE**



SMR
ELEVATOR BROAD



SMR
ELEVATOR FINE



COTTLE
ELEVATOR
SLIGHT CURVED



MASING
ELEVATOR WITH
GRADUATED



HOWARTH
ELEVATOR



Dr. V.P. SOOD
ELEVATOR



JOSEPH NASAL
ELEVATOR



DISSECTOR
WITH SUCCER



FREER
ELEVATOR



FOMAN UPPER
LATERAL SCISSORS



WALTER SCISSORS
CURVED ANGLED 10 CM



LUC NASAL TURBINATE
FORCEPS OVAL SHAPE



SMALL



MEDIUM



LARGE



**HEYMANN TURBINECTOMY
SCISSORS**



**FOMAN ANGULAR
SCISSORS**



SEPTUM MORCELIZER



**SEPTUM CUTTING
PUNCH**



**SEPTUM CUTTING
SCISSORS**



**COTTLE SEPTAL
SCISSORS**



KNAPP SCISSORS
CURVED- S.S

KNAPP SCISSORS
STRAIGHT- S.S



IRIS SCISSORS
CURVED - S.S

IRIS SCISSORS
STRAIGHT - S.S

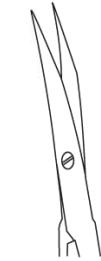

**STEVENS
SCISSORS
CURVED - S.S**



4 1/2"
5 1/2"
**STEVENS SCISSORS
CURVED - SUPER CUT**

**STEVENS
SCISSORS
STRAIGHT - S.S**

**STEVENS SCISSORS
STRAIGHT - SUPER CUT**



**GREEN BERG
SCISSORS
(KILNER) CURVED
S.S**



5"
6"
**GREEN BERG SCISSORS
(KILNER)
CURVED
SUPER CUT**

**GREEN BERG
SCISSORS
(KILNER) STRAIGHT**

5"
6"
**GREEN BERG SCISSORS (KILNER)
STRAIGHT - SUPER CUT**



WATSON WILLIAMS
NASAL POLYPUS FORCEPS

BIOPSY
PUNCH FORCEPS

SIZE
5 MM
6 MM
7 MM



AUFRIGHT
NASAL RETRACTOR
WITH FIBEROPTIC LIGHT

AUFRIGHT
NASAL RETRACTOR



WALSHAM SEPTUM
STRAIGHTENING FORCEPS

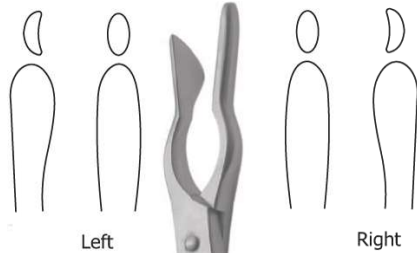

Left

Right



WALSHAM SEPTUM
FORCEPS



ASH SEPTUM
FORCEPS



V.P. SOOD AUFRIGHT
NASAL RETRACTOR



MALLET

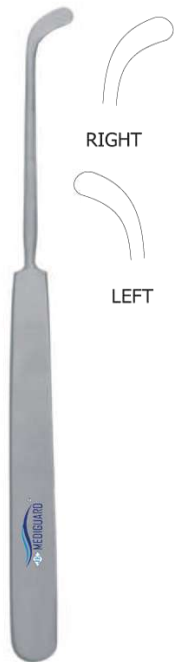

**ROSS RASPATORY
RIGHT**



**SILVER CHISEL
LEFT**



**SILVER CHISEL
RIGHT**



**SILVER CHISEL
STRAIGHT**

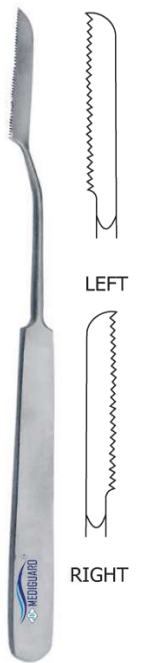

**JOSEPH NASAL
SAW LEFT**



**ROZNER NASAL
OSTEOTOME**



**GILLIES
CHISEL**



**GILLIES
GOUGE**



**GILLIES
OSTEOTOME**



**OSTEOTOME
MOON TYPE**



**MEASURING
OSTEOTOME**



MALTZ RASP



JOSEPH NASAL RASP FINE



AUFRIGHT NASAL RASP



JOSEPH NASAL RASP



FOMON FINE CUTTING RASP - S.S



FOMON MEDIUM CUTTING RASP - S.S



FOMON SHARP CUTTING RASP - S.S

KAL



CALIPER STRAIGHT



CALIPER CURVED



SILVER SKIN GRAFTING KNIFE FOR SAVING BLADES USE



HUMBY SKIN GRAFTING HANDLE



WATSON SKIN GRAFTING HANDLE



CATLAGE CRUSHER



INSTRUMENT BOX



AUTOCLAVE INSTRUMENT BOX WITH SILICON MATT



**WIRE CUTTING
SCISSORS**

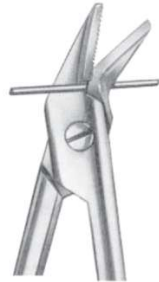

**TUNGSTEN
CARBIDE**



SUCTION TUBE

NEEDLE

KNIFE



CABLE



Suction Dissector for Sinus
Double Curved Backwards,
Left Side, **6 MM**



Suction Dissector for Sinus
Double Curved Backwards,
Right Side, **6 MM**



Suction Dissector
Double Curved Forwards,
Left Side, **6 MM**



Suction Dissector
Double Curved Forwards,
Right Side, **6 MM**



V. EICKEN ANTRUM CANNULA
15CM, SHORT CURVED



EICKEN ANTRUM CANNULA
LONG CURVED



SUCTION IRRIGATION TUBE
WITH CHANNEL



POINTED TIP



ROUND TIP



SINUS SICKLE KNIFE



ANTRUM BALL PROBE
DOUBLE ENDED



MALLEABLE SUCTION



MALLEABLE PROBE



DR. KIRTANE ELEVATOR WITH KNIFE



D.C.R. DILATOR



D.C.R. PROBE

BILLSHAPED BEAK



OBLIQUE BEAK



TROCAR AND CANNULA
SINUSCOPY O.D. 5MM,
CANNULA 8.5CM

SINUSCOPE (TELESCOPES)

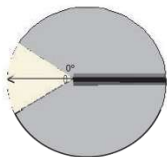
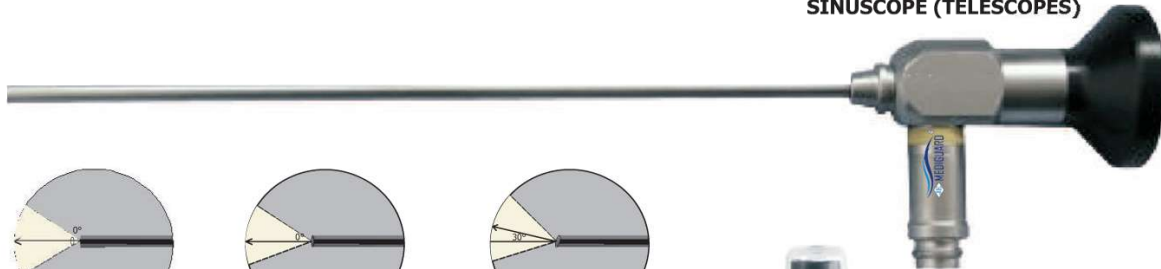

STRAIGHT FORWARD
WIDE ANGLE 0° 2.7MM

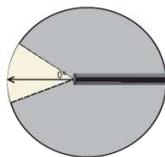

STRAIGHT FORWARD
WIDE ANGLE 0° 4MM

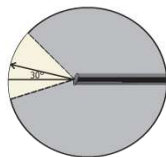

FORWARD OBLIQUE
WIDE ANGLE 30° 2.7MM

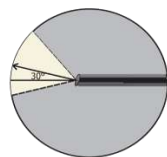

FORWARD OBLIQUE
WIDE ANGLE 30° 4MM

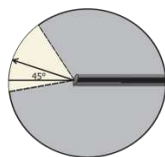

FORWARD OBLIQUE
WIDE ANGLE 45° 4MM

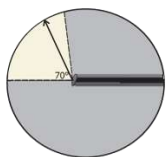

LATERAL WIDE ANGLE
70° 4MM



LENS CLEANER SPRAY



SINUSCOPE HANDLE
ROUND 11CM



ANTRUM CURETTE
19CM



FORWARD CUTTING



BACKWARD CUTTING



ANTRUM CURETTE
OVAL DOUBLE CURVED
19cm



Small 45° Angled
(2.5x6.0 MM)



Large 45° Angled
(4.0x9.0 MM)



55° Angled
(2.5x6.0 MM)



90° Angled
(2.5x6.0 MM)



SMR
ELEVATOR



SMR
ELEVATOR
FINE



MASING
ELEVATOR
GRADUATED



Straight



Right



Left



NASAL SCISSORS,
SERRATED BLADES, WORKING
LENGTH 13CM
S.S



Straight



In 45°



Up 90°



Down



**BLAKESLEY NASAL
FORCEPS**
S.S



THROUGH CUTTING PUNCH,
Frontal Sinus Punch Forceps 55°
Double Action Cup 2mm
Working Length 14.5cm - **S.S**



- UP



DOWN



LEFT



RIGHT



ANTRUM PUNCH,
BACKWARD CUTTING,
WORKING LENGTH 13MM
S.S



Straight



Right



Left



NASAL SCISSORS,
SERRATED BLADES, WORKING
LENGTH 13CM



Straight



Up 45°



Up 90°



Down



**BLAKESLEY NASAL
FORCEPS**



Straight



Up 45°



**BLAKESLEY NASAL
WITH SUCTION**



UP



DOWN



LEFT



RIGHT



ANTRUM PUNCH,
BACKWARD CUTTING,
WORKING LENGTH 13MM

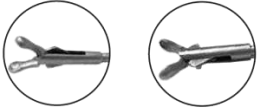

THROUGH CUTTING PUNCH,
Frontal Sinus Punch Forceps 55°
Double Action Cup 2mm
Working Length 14.5cm

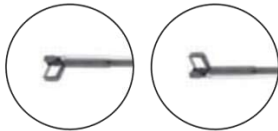

LEFT RIGHT



ANTRUM PUNCH,
SIDE CUTTING,



FRONTAL SINUS PUNCH,
70° UPCURVED
(COBRA PUNCH)

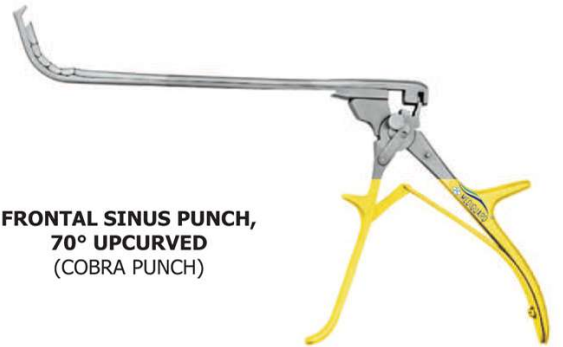

ANTRUM POLYP
GRASPING FORCEPS,
RETROGRADE OPENING



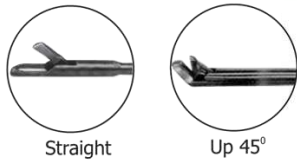

THROUGH CUTTING Punch



UP BACK BITTING TOPI Punch

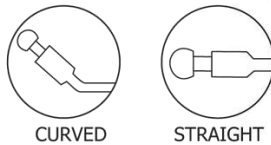

CIRCULAR MUSHROOM Cutting Punch

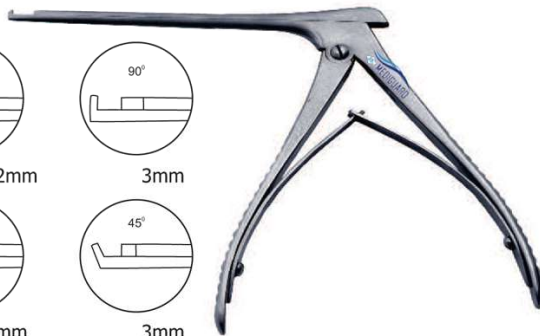
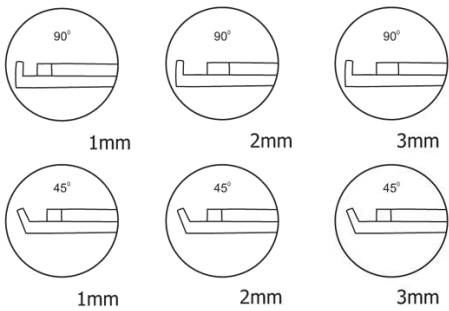

ANTRUM PUNCH, through-Cutting wide 1mm, 2mm, working Length 13mm, with Reservoir to pickup and collect bone material.

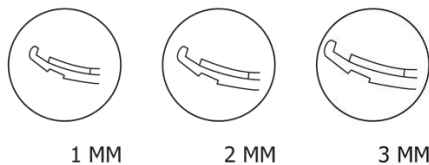

D.C.R. PUNCH

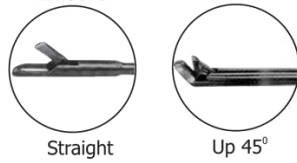

THROUGH CUTTING Punch



UP BACK BITTING TOPI Punch

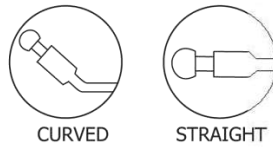

CIRCULAR MUSHROOM Cutting Punch

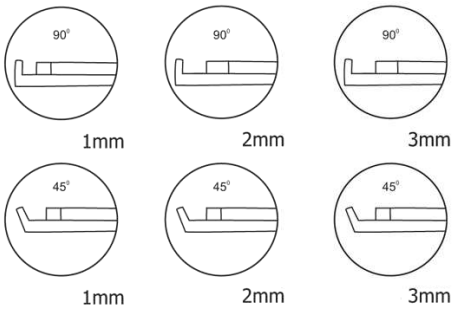

ANTRUM PUNCH, through-Cutting wide 1mm, 2mm, working Length 13mm, with Reservoir to pickup and collect bone material.

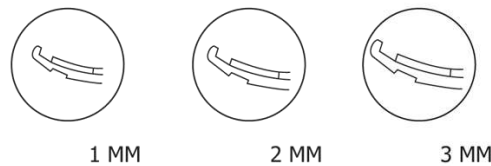
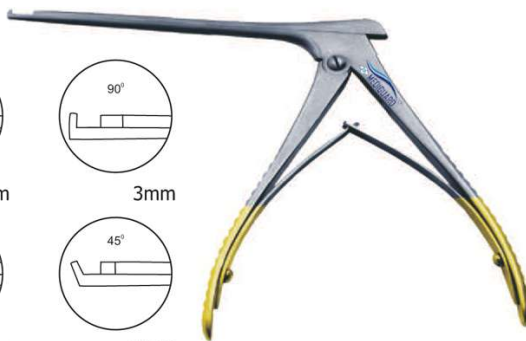

D.C.R. PUNCH





PEDIATRIC FINE
STRAIGHT



NASAL SCISSORS,
SERRATED BLADES, WORKING
LENGTH 12CM
PEDIATRIC



PEDIATRIC FINE
Straight
1.5MM



PEDIATRIC FINE
Up 45°
1.5MM



BLAKESLEY NASAL
FORCEPS
LENGTH 12CM
PEDIATRIC



PEDIATRIC
UP 2MM



PEDIATRIC
DOWN 2MM



ANTRUM PUNCH,
BACKWARD CUTTING,
WORKING LENGTH 12 CM
PEDIATRIC



PEDIATRIC
Straight



PEDIATRIC
Up 45°



THROUGH CUTTING Punch
PEDIATRIC



TONGUE DEPRESSOR
SET OF 3



NEGUS TONSIL
ARTERY FORCEPS
HALF CURVED



NEGUS TONSIL
ARTERY FORCEPS
FULL CURVED

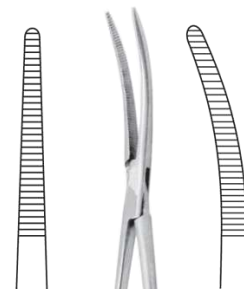

STRAIGHT

CURVED

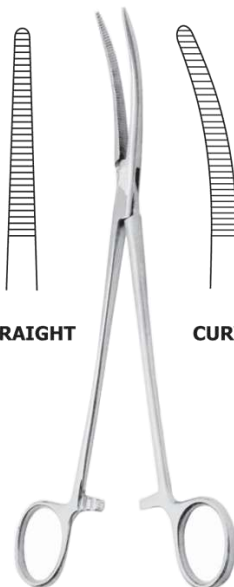

BIRKETT TONSIL
ARTERY FORCEPS



TONSIL FINE
METZENBAUM
SCISSORS
CURVED-S.S

TONSIL FINE
METZENBAUM SCISSORS
STRAIGHT-S.S



TONSIL FINE
METZENBAUM
SCISSORS
CURVED
TUNGSTEN
CARBIDE

TONSIL FINE
METZENBAUM SCISSORS
STRAIGHT
TUNGSTEN
CARBIDE



TONSIL FINE
METZENBAUM
SCISSORS
CURVED
SUPER CUT

TONSIL FINE
METZENBAUM SCISSORS
STRAIGHT
SUPER CUT



WILSON
ARTERY FORCEPS



DENIS BROWNE
TONSIL HOLDING FORCEPS



COLVER TONSIL
HOLDING FORCEPS



TONSIL
NEEDLE HOLDER
S.S



TONSIL
NEEDLE HOLDER
TUNGSTEN CARBIDE



NEGUS PUSHER
KNOT TIER



EVE TONSIL
SNARE



WIRE



HURD TONSIL
DISSECTOR



HANKE TONSIL
DISSECTOR ONE
SIDE SERRATED



TONSIL PILLAR
RETRACTOR & DISSECTOR



TONSIL NEEDLE RIGHT

TONSIL NEEDLE LEFT

TONSIL KNIFE LEFT

TONGUE TIE PROBE

YANKAUER TONSIL SUCTION TUBE

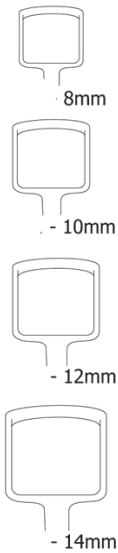

BACKMANN ADENOID CURETTE

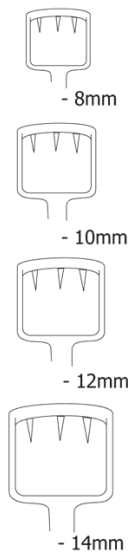

ST. CLAIR THOMPSON ADENOID CURETTE WITH CAGE

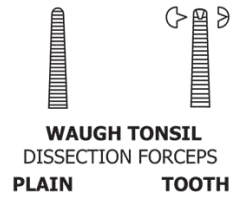

WAUGH TONSIL DISSECTION FORCEPS



**BOYLE DAVIS MOUTH GAG
WITH 3 TONGUE PLATES - CHILD**



**BOYLE DAVIS MOUTH GAG
WITH 4 TONGUE PLATES - ADULT**



**DOUGHTY SLOTTED MOUTH GAG
WITH 4 TONGUE PLATES**

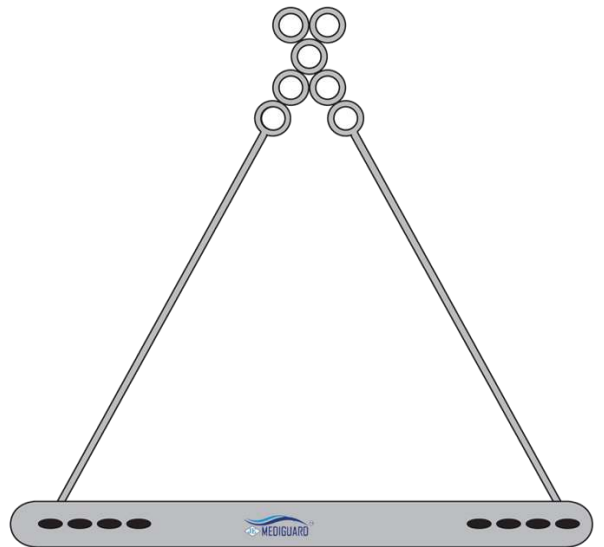

**DRAFFIN BIPOD STAND
WITH PLATES**

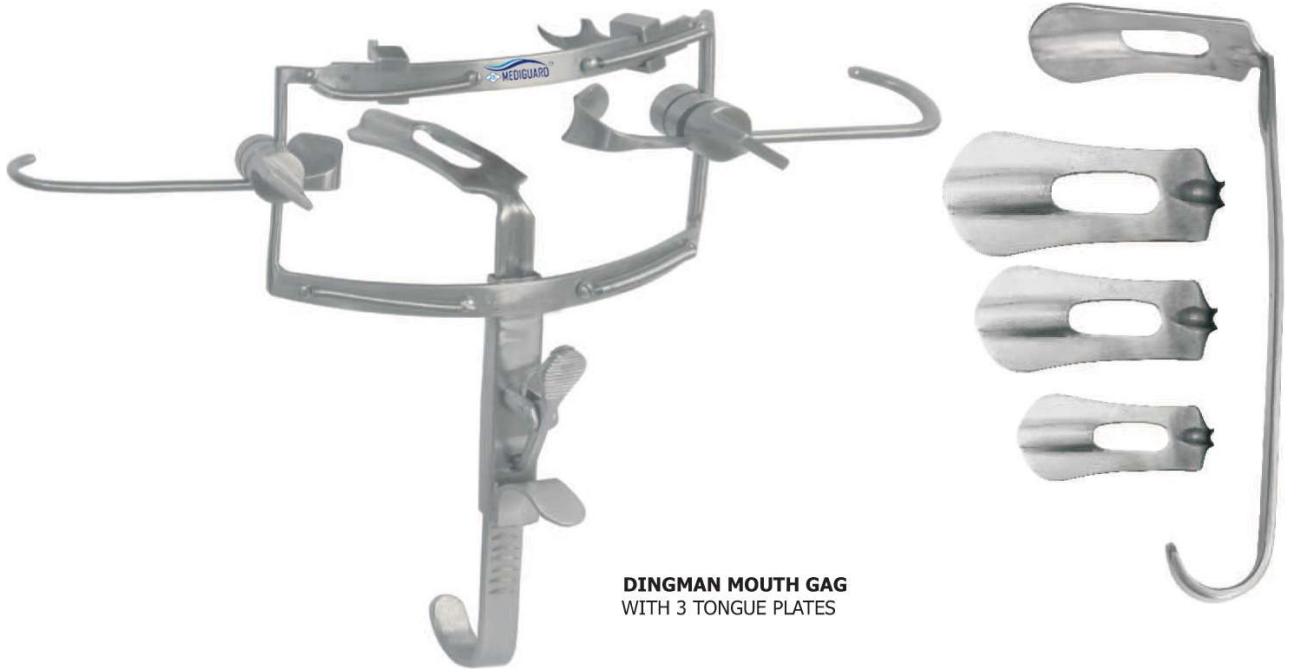

DINGMAN MOUTH GAG
WITH 3 TONGUE PLATES



4
HEISTER
MOUTH GAG



JENNINGS
MOUTH GAG



DOYAN MOUTH GAG
ADULT
CHILD

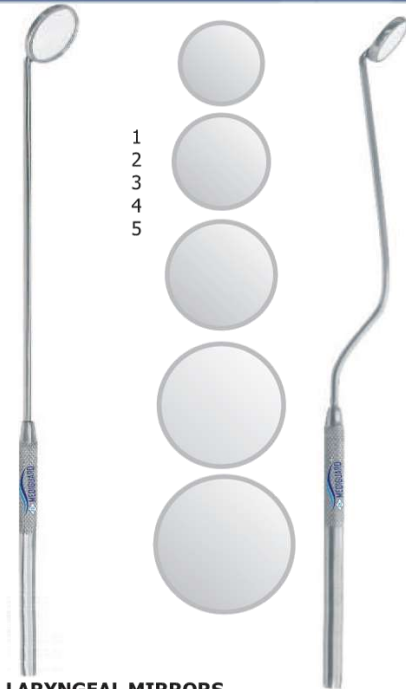

LARYNGEAL MIRRORS
WITHOUT HANDLE

POST RHINOSCOPIC
MIRROR WITHOUT HANDLE

- 1
- 2
- 3
- 4
- 5



5011
MIRROR
HANDLE



5012
TONGUE HOLDING
FORCEPS



5013
BACKHAUS TOWEL
FORCEPS



LANGEN BECK
RETRACTOR
SMALL
MEDIUM



VOLKMANN
RETRACTORS
3 PRONGS
4 PRONGS

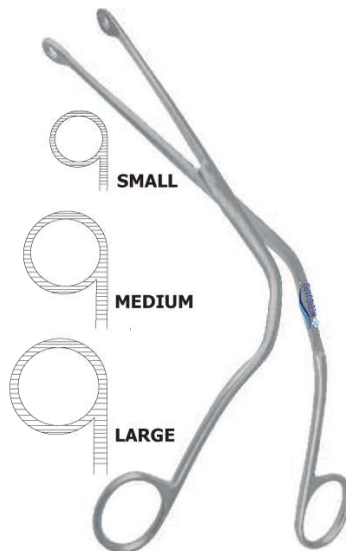

MAGILL
INTRATRACHEAL
CATHETER FORCEPS



TRACHEAL DILATING
FORCEPS



TOWEL CLIP
CROSS SECTION



TRACHEAL RETRACTOR
1 PRONG SHARP

TRACHEAL RETRACTOR
1 PRONG BLUNT

TRACHEAL RETRACTOR
2 PRONGS BLUNT



FULLER TRACHEOTOMY
TUBE ALL METAL
18FG
20FG
22FG
24FG
26FG
28FG
30FG
32FG
34FG
36FG



JACKSON TRACHEOTOMY
TUBE ALL METAL
12FG 28FG
14FG 30FG
16FG 32FG
18FG 34FG
20FG 36FG
22FG 38FG
24FG 40FG
26FG 42FG



BARD PARKER
HANDLE No. 3



BARD PARKER
HANDLE No. 4



BARD PARKER
HANDLE No. 7



B.P. HANDLE
ROUND



10



11



12



15



20



21



22



23



24

BARD PARKER BLADES
No. 10, 11, 12, 15, 20, 21, 22, 23, 24



MAGILL LARYNGOSCOPE
WITH BLADES

- SET OF 2 BLADES
- SET OF 3 BLADES
- SET OF 4 BLADES



LAMP FOR LARYNGOSCOPE



McINTOSH LARYNGOSCOPE
WITH BLADES

- SET OF 3 BLADES
- SET OF 4 BLADES



FIBER OPTIC LARYNGOSCOPE
SET OF 3



**WEERDA DISTENDING
OPERATING LARYNGOSCOPE**
LARGE ADULT SIZE F.O.L.L.,
INJECTION CANNULA INSERTABLE
SUCTION TUBE



**ANTERIOR COMMISSURE
LARYNGOSCOPE with
ENDOSCOPE CARRIER**



**NEGUS ANTERIOR
COMMISSURE LARYNGOSCOPE**
with LONG CUT with FIBER
OPTIC CARRIER

**HYPO PHARYNGOSCOPE with
FIBER OPTIC CARRIER**
CHILD
ADULT



**ANTERIOR COMMISSURE
LARYNGOSCOPE with
FIBER OPTIC CARRIER**
PEDIATRIC
MEDIUM
LARGE



**LARYNGOSCOPE
HOLDER and CHEST SUPPORT**



JACKSON LARYNGOSCOPE
ADULT with FIBER OPTIC
CARRIER



LARYNGEAL SUCTION

TUBE 25CM
 1 No. 2 No.
 3 No. 4 No.



MONOPOLAR LARYNGEAL NEEDLE

MONOPOLAR LARYNGEAL SUCTION TUBE



SUCTION RASPATORY, NEEDLE STRAIGHT, 23 CM



LARYNGEAL FORCEPS, TUBULAR MODEL, CURVED, OVAL CUPS



LARYNGEAL FORCEPS, TUBULAR MODEL, CURVED, ALLIGATOR



MICRO LARYNGEAL PICK 90°



MICRO LARYNGEAL SWAB HOLDER



MICRO LARYNGEAL Knife Straight



MICRO LARYNGEAL Probe 90°



MICRO LARYNGEAL Probe Straight



MICRO LARYNGEAL Plester oval Knife



MICRO LARYNGEAL Round Knife 45°



MICRO LARYNGEAL Peeling Knife



MICRO LARYNGEAL Sickle Knife Curved



MICRO LARYNGEAL Handle



UNIPOLAR COAGULATION FORCEPS, ROTATABLE, SERRATED, 25cm

UNIPOLAR COAGULATION FORCEPS, ROTATABLE, CUP, 25cm

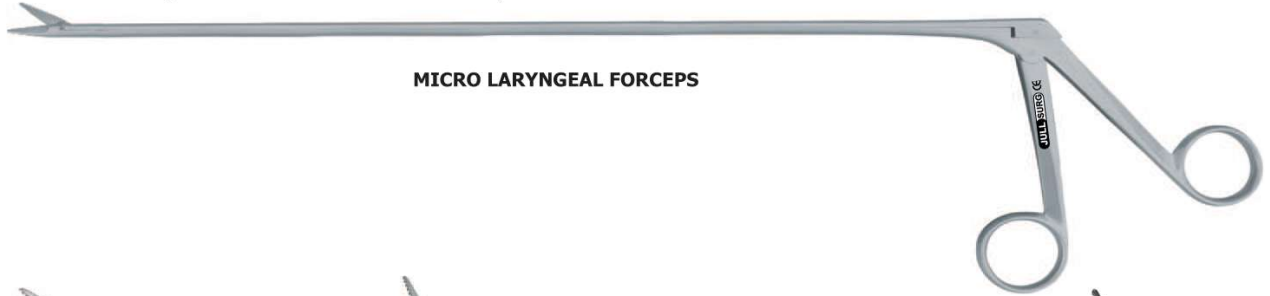

MICRO LARYNGEAL FORCEPS



MICRO LARYNGEAL Forceps Serrated Jaw
25cm
35cm



MICRO LARYNGEAL Forceps Serrated Jaw Curved Right
25cm



MICRO LARYNGEAL Forceps Serrated Jaw Curved Left
Size 25cm



MICRO LARYNGEAL Forceps Serrated Jaw Upward
Size 25cm



MICRO LARYNGEAL Forceps Cup Jaw Straight
25cm
35cm



MICRO LARYNGEAL Forceps Cup Jaw Curved Right
Size 25cm



MICRO LARYNGEAL Forceps Cup Jaw Curved Left
Size 25cm



MICRO LARYNGEAL Forceps Cup Jaw Upward
Size 25cm



MICRO LARYNGEAL Scissors Straight
Size 25cm



MICRO LARYNGEAL Scissors Curved Right
Size 25cm



MICRO LARYNGEAL Scissors Curved Left
Size 25cm



PATTERSON BIOPSY Forceps
Size 25cm
Size 35cm
Size 45cm
Size 55cm



JACKSON GRASPING Forceps
Size 25cm
Size 35cm
Size 45cm
Size 55cm



JACKSON FOREIGN Body Forceps
Size 25cm
Size 35cm
Size 45cm
Size 55cm



VOCAL NODULE FORCEPS
Size 25cm
Size 35cm
Size 45cm
Size 55cm



BIOPSY PUNCH Forceps
Size 25cm
Size 35cm
Size 45cm
Size 55cm



BRONCHOSCOPE
WITH FIBER LIGHT CARRIER
3MMx27CM 8MMx40CM
5MMx30CM 9MMx45CM
7MMx35CM 10MMx50CM

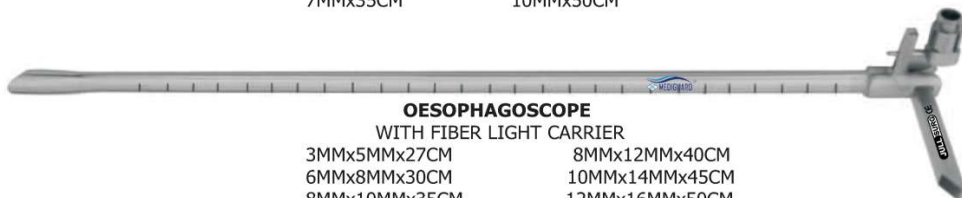

OESOPHOSCOPE
WITH FIBER LIGHT CARRIER
3MMx5MMx27CM 8MMx12MMx40CM
6MMx8MMx30CM 10MMx14MMx45CM
8MMx10MMx35CM 12MMx16MMx50CM



BRONCHOSCOPE
SUCTION TUBES
35CM
45CM
55CM

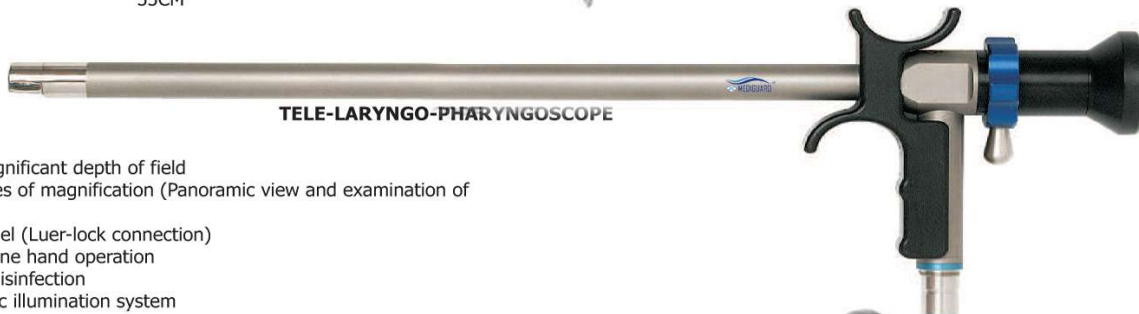

TELE-LARYNGO-PHARYNGOSCOPE

FEATURES :

- Sharp image with significant depth of field
- Two different degrees of magnification (Panoramic view and examination of details)
- Integrated air channel (Luer-lock connection)
- Focusable through one hand operation
- Soakable for liquid disinfection
- Integrated fiber optic illumination system

TECHNICAL DATA

Outer dia. of probe	10 mm
Working length	170mm
Vision direction	90° lateral
Field of view	60°
Working distance	15mm to infinity



FLEXIBLE RHINO LARYNGO PHARYNGOSCOPE

FEATURES :

- High resolution fiber optic image guide; 9800 Pixel
- Single fiber diameter 10 micron
- High flexibility through increased angulation angle of distal tip
- High Image contrast with increased image diameter
- soakable for liquid disinfection

TECHNICAL DATA

Outer diameter of flexible probe	3,8 mm
Length	300 mm
Vision Direction	0° direct
Field of view	85°
Angulation	2-way each app. 150°
Working distance	3 mm to infinity



**BIPOLAR COAGULATION
FORCEPS BAYONET TYPE**

**BIPOLAR
COAGULATION
FORCEPS BAYONET TYPE
WITH TWO PINS**

**BIPOLAR
COAGULATION
FORCEPS BAYONET TYPE
WITH SUCTION**

**BIPOLAR
COAGULATION
FORCEPS (ST.)**

**BIPOLAR
COAGULATION
FORCEPS (ST.)
WITH TWO PINS**

**BIPOLAR
FORCEPS 60°
CURVED, 18cm**



**BIPOLAR
COAGULATION
FORCEPS CURVED**

**BIPOLAR COAGULATION
FORCEPS CURVED
WITH TWO PINS**

**BIPOLAR
COAGULATION
FORCEPS CURVED**

**BIPOLAR
COAGULATION
FORCEPS CURVED
WITH SUCTION**

**BIPOLAR
COAGULATION
FORCEPS CURVED
WITH TWO PINS**



CABLE





MICRO FORCEPS
1 x 2 TEETH
S.S

MICRO FORCEPS
PLAIN - S.S



184
NO
:PS
:ETH
:UM



JEWELLERS MICRO FORCEPS NO. 3



No.3



No.7



Toothed
No.7



Angled
no. 5-A



No.5



Toothed
No.5



MICRO SPRING SCISSORS
STRAIGHT - S.S



MICRO SPRING SCISSORS
CURVED - S.S



6"
**MICRO SPRING
NEEDLE HOLDERS**
WITH LOCK CURVED - S.S



6"
**MICRO SPRING
NEEDLE HOLDERS**
WITH LOCK STRAIGHT - S.S



6"
**MICRO SPRING
NEEDLE HOLDERS**
WITH OUT LOCK CURVED - S.S



6"
**MICRO SPRING
NEEDLE HOLDERS**
WITH OUT LOCK STRAIGHT - S.S

MICR
v



CHEATLE FORCEPS



CHEATLE JAR



**KILNER NEEDLE
HOLDERS FINE
S.S**



**MICRO FINE
NEEDLE HOLDER
S.S**



**MOSQUITO FORCEPS
CURVED**

**MOSQUITO FORCEPS
STRAIGHT**



ATOMISER



PORP



TORP



GROMMET



TEFLON PISTON



FORMALIN CHAMBER

- SIZE
12"
14"
21"
23"
26"



**SILASTIC
SHEET
2.5CM X 5CM**



**SILICON
TUBE**



FIBER OPTIC HEAD LIGHT
Band



LED LIGHTS HEADBAND WITH REACHABLE BATTERY 5 V



FIBER OPTIC CABLE
3.5 mm length 230 cm
4.5 mm length 230 cm



BULLS EYE LAMP FOLDING



HALOGEN FIBER OPTIC COLD LIGHT SOURCE
DOUBLE POINT 24 V - 250 W



CORDLESS HEADLIGHT



ULTRA COMPACT MINI XENON LIGHT SOURCE 300W



HALOGEN FIBER OPTIC COLD LIGHT SOURCE
SINGLE POINT 15 V - 150 W



MURPHY HEAD MIRROR



LED LIGHTS SOURCE



SURGICAL TRAY WITH LID
HEAVY STAINLESS STEEL



DRESSING DRUMS
SEAMLESS STAINLESS STEEL



MEASURING BOWL



BAD PANS
STAINLESS STEEL
MALE
FEMALE



BOWL
STAINLESS STEEL



KIDNEY TRAY



EUROVAC ELECTRIC
SUCTION MACHINE



PORTABLE SINGLE DRUM
AUTOCLAVE STAINLESS STEEL
HEAVY DUTY 12" X 12"



MICRO HANDPIECE WITH 35,000 RPM



MICRO STRAIGHT HANDPIECE WITH 40,000 RPM



MICRO SURGICAL STRAIGHT HANDPIECE WITH 40,000 RPM



MICRO SURGICAL ANGULAR HANDPIECE WITH 50,000 RPM TO 80,000 RPM



High Performance Autoclave Titanium Brushless Micro Motor with Precise Torque control for Implant & Micro Surgery with Digital Display



SURGICAL MICRO DRILL Heavy Duty Micro Motors for forward & reverse cutting 40,000 rpm



Heavy Duty Micro Motors for forward & reverse cutting 40,000 rpm

ELECTRO SURGICAL CAUTERY UNIT



EXCLUSIVE FEATURES

- Advance Embedded Technology based Micro Controller
- Solid State C.M.O.S. integrated circuits.
- Totally Digital Display for every mode.
- Mono-polar cutting/coagulation, blended output.
- Bi-polar cutting/bipolar coagulation
- Independent activation of hand switch and Foot switch
- Audio Visual alarm for separate mode.

EAR PIERCING SYSTEM





MANUFACTURER & EXPORTER

**ENDOSCOPY
EQUIPMENT**



JULLUNDUR ENTERPRISES

JULLUNDUR ENTERPRISES

DIGITAL COLD LED LIGHT SOURCE

Technical Parameters

- Key Features
- MCU based: Smart Micro Controller based
- Digital Intensity control {2% ~ 100%}.
- SMART INTENSITY CONTROL:
- Up key to increase the intensity by MCU(micro control unit)
- DOWN key to decrease the intensity by MCU(micro control unit)
- Sleep Mode with resume mode (led intensity reduced directly to 2% can be resumed to last working mode).
- Press key once intensity drops to 2 %
- Resume mode press key again equipments resumes to last working mode
- This saves the power by 90 %
- Smart intensity bar display



FIBRE COMPATIBILITY



- Power Mode (SMPS): switching mode power supply
- Time with working operation with-in memory
- Buzzer.
- Free Input voltage 85V~240V 50 Hz
- Light suitable of diagnostic and general surgery both.
- Working temperature : 10 ~ 70 degree
- Power Consumption as Compared to halogen and xenon light source
- LOW HEAT: as compared to xenon or halogen bulbs
- Dimensions:- WXHXD 155mm x 155mm x 310mm
- Weight: 2.8kg approx

JULLUNDUR ENTERPRISES

DIGITAL COLD LED LIGHT SOURCE

Product Introduction

JULLUNDUR ENTERPRISES proud to introduce the state of art rigid and advance micro controller <PWM> based digital cold led light source equipped with the power of 80 watts(LED from Germany) PLPO (Peak light power output). 4 years of our hard work and research from our strong R&D team, we develop this product. Low maintains and compatible with every OPD, diagnostic and surgery this light source can be use for head light and boroscope, It gives 98% light at the tip of endoscope to see crisp and clear picture. This product is completely made in India so no need to worry about after sales services and about the parts.

- **LED** : Original LED from Germany with **on board** lens for more light density and focused.
- **True White Balance** :- (TWB) A perfect blend of white and yellow light emitting the right colour temperature of day light.
- **POWER SEGMENT** :- designed from UL listed components and safe to use. output section completely isolated from the input 220V **through octocoupler (prevents the high voltage to affect the internal circuit).**
- **SMART LED BAR** :- LED display bar for intensity display designed for quick study of led power.
- **COMPACT SIZE** :-LED light source designed with ultra bright LED light in compact size with proper heat management solution and quite working.
- **SLEEP MODE 80L** comes with the extra feature of sleep mode with which user can minimize the power usage of 80 when not in use and resume the intensity at last working step.

OTHER LIGHT SOURCE MODELS



120W



120W

JULLUNDUR ENTERPRISES

OPD UNIT

Technical Specification

- Sensor - 1/3 CCD sensor
- Color system - PAL
- Resolution - 960 h
- White balance - Yes (by pressing key)
- Signal to Noise Ratio - 52db
- Sensitivity - 0.2 lux
- Electronic Shutter Speed - 1/25~1/100000
- Back light control - Yes (auto)
- R>G>B gain control - Yes (by factory setting only)
- Anti glair - yes
- Ir protection - Yes (by IR cut filter)
- Output - R/C + BNC
- Lens mount - C/Cs mount
- Cable - 2.8 meters

COUPLER COMPATIBILITY C/Cs MOUNT



CAMERA HEAD



- Camera coupler - Optional-(18,20,22,25)
- Camera connector - Type metallic
- Size of Camera head Unit (W*H*D) - 35mm*35mm*43mm
- Weight - 75gm
- Housing Type - Metal (baked painted) with on board shortcut Keys + red led for W/B

JULLUNDUR ENTERPRISES

OPD UNIT

Product Introduction

JULLUNDUR ENTERPRISES proud to introduce FIRST TIME MADE IN INDIA the state of art rigid and advance ENDOSCOPIC UNIT for OPD (CAMERA HEAD + CONTROL UNIT) all in one, it is easy to operate and carry anywhere, SD camera give you very good crisp and clear picture quality

CCD chipset from JAPAN gives you very good depth of field of the picture and it comes with adjustable white balance by pressing key. Also, you can adjust the colour gain and brightness of the picture, whenever you want by pressing shortcut menu keys. It is a very helpful function for diagnostics. Camera head design is very good and very handy and easy to operate.

Menu shortcut keys:

- Colour gain control easy to use with the shortcut keys for basic adjustments of the colour gain form (0-99) for the colour suitable to the customer
- W/B control key to set the true colour format with the single touch of the button + indication led for the W/b report.

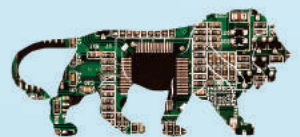
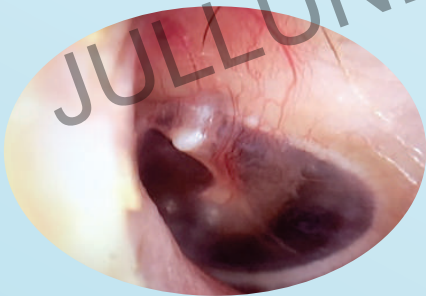
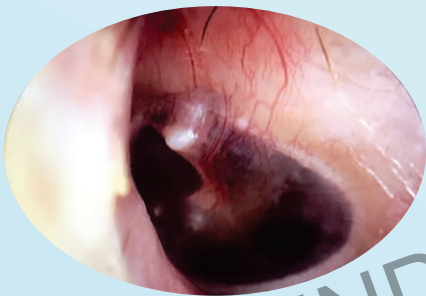

JULLUNDUR ENTERPRISES

1568-A, G-22-23, BHAGIRATH PALACE, DELHI 110006, INDIA

Mobile : +91 9871432046 / +91 9999329288

Email : info@jemediguard.com

Web : www.jemediguard.com

JULLUNDUR ENTERPRISES

FHD ENDOSCOPIC UNIT

Technical Specification

CAMERA

- Sensor - 1/2.8" Digital Cmos sensor
- Resolution - 1080P
- Display Ratio - 16:9
- Image Processor - Medical Grade (Korean)
- Synchronization - Digital signal @2.9GHz
- White balance - Yes (by pressing key)
- Signal to Noise Ratio - 52db
- Ir protection - Yes (by IR cut filter)
- Output - HDMI + DVI
- Lens mount - C/Cs mount
- Cable - 2.8 meters
- Front panel - OSD (On Screen Display)
W/B+color control
- Power Segment - ESD Protection
O/C Protection
- Sensitivity - 0.2 lux
- Gamma curve - Yes (default)
- Electronic Shutter - 1/25~1/100000
- Back light control - Yes (auto)
- Color accuracy - 99% true color spectrum
- Anti glare - yes
- Output resolution - 1920*1080 HDMI + DVI
- Color control - (0-10) color setting
- Indicator - power + camera connect
- Camera connector - self locking metal case
- Camera head - IPX4 rating

COUPLER COMPATIBILITY C/Cs MOUNT



JULLUNDUR ENTERPRISES

FHD ENDOSCOPIC UNIT

Product Introduction

JULLUNDUR ENTERPRISES proud to introduce FIRST TIME MADE IN INDIA the state of art rigid and advance ENDOSCOPIC UNIT for Diagnostic + Surgical unit (HD CAMERA+CONTROL UNIT) all in one, it's easy to operate and carry anywhere, FHD camera give you very good crisp and clear picture quality

CMOS sensor which provides the true colour definition with the true spectrum and colour gain curve. The CMOS technology is digital sensor technology integrated with the DSP (digital signal processor) to give the perfect picture quality. Colour Definition with 1 million colour curve processing 30 frames per second

(Digital Chipset) as this chip gives you very good depth of field of the picture and it comes with adjustable White Balance by pressing key. You can also adjust the Colour Gain function to adjust color gain as per your choice. Camera Head designed for handy use and ease of operation with small size and premium quality material.

Menu shortcut keys:

- **COLOR(-)** Colour gain control easy to use with the shortcut keys for basic adjustments of the colour gain increasing and decreasing, (0-10 for the colour suitable to the customer)
- **WHITE BALANCE---**W/B control key to set the true colour format with the single touch of the button + indication led for the W/b report.

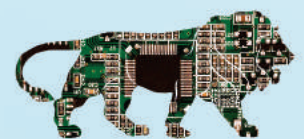
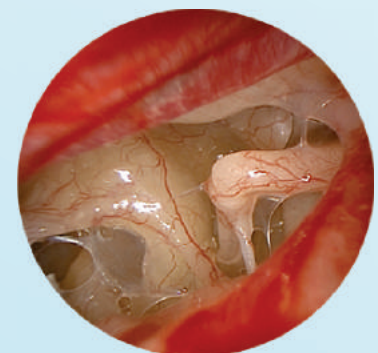
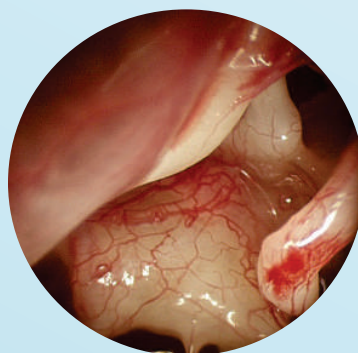
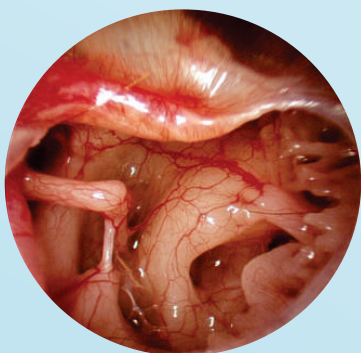

JULLUNDUR ENTERPRISES

1568-A, G-22-23, BHAGIRATH PALACE, DELHI 110006, INDIA

Mobile : +91 9871432046 / +91 9999329288

Email : info@jemediguard.com

Web : www.jemediguard.com

JULLUNDUR ENTERPRISES

FHD ENDOSCOPIC UNIT with RECORDING



Product Introduction

JULLUNDUR ENTERPRISES proud to introduce FIRST TIME MADE IN INDIA the state of art rigid and advance ENDOSCOPIC UNIT for Diagnostic + Surgery (HD CAMERA+CONTROL UNIT) all in one, it's easy to operate and carry anywhere, FHD camera gives you very good crisp and clear picture quality

PANASONIC sensor which provides the true colour definition with the true spectrum and colour gain curve. The CMOS technology is digital sensor technology integrated with the DSP (digital signal processor) to give the perfect picture quality. Colour Definition with 1 million colour curve processing 30 frames per second

(Chipset from Korea) as this chip gives you very good depth of field of the picture and it comes with adjustable White Balance by pressing key, also you can adjust the Colour Gain and FREEZE function to freeze live picture, whenever you want by pressing shortcut menu keys its very help full function for diagnostics, we design camera nicely for handy use and easy to operate.

JULLUNDUR ENTERPRISES

FHD ENDOSCOPIC UNIT

Menu shortcut keys:

- **COLOR---** Colour gain control easy to use with the shortcut keys for basic adjustments of the colour gain increasing and decreasing.
- **FREEZE-----** This option is helpful in diagnostic and teaching features, to lock the live picture for study function.
- **AUTO GAIN CONTROL—** Backend software supported exposure which automatically control the shutter for the incoming light.
- **WHITE BALANCE---**W/B control key to set the true colour format with the single touch of the button + indication led for the W/B report.

Camera Secification

CAMERA

- Sensor - 1/2.8" (PANASONIC) Cmos sensor
- Image Processor - Medical Grade (Korean)
- Synchronization - Serial data interface
- Signal to Noise Ratio - 52db
- Output Resolution - 1920*1080 @ 25Hz H-18.8Khz V-25Hz
- Gamma correction - Yes (by default processing @ curve 4.5deg)
- Electronic Shutter - 1/25~1/10000
- Sensor Resolution - 7.34 MP
- White balance - Yes (by pressing key)
- Back light control - Yes (auto)
- R>G>B>Y GAIN/ HUE control - Yes (by factory setting only)
- Anti glair - yes
- Lens mount - C/Cs mount
- Cable - 2.8 meters
- Front panel - OSD(on screen display)
- Shortcut keys - AWB + FREEZE
- Camera coupler - Optional-18,20,22,25



Recording Specifications

- Interface - USB 2.0 HOST
- Codec - Hardware H.264 Encoder
- Resolution - 1920*1080P(60i) , 1920*1080(25p)
- Recording format - Video MP4
- Recording Quality - 1080 @ 18Mbps
- Record File - Max 2GB/file With RTC

LED Specification (optional model)

- Wattage - 3W
- Display - OLED display
- LED AGE - Display OLED Time/Age
- INTENSITY - UP,DOWN (steps10%)
- Notification - Buzzer indicator

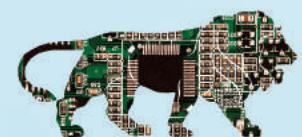

JULLUNDUR ENTERPRISES

1568-A, G-22-23, BHAGIRATH PALACE, DELHI 110006, INDIA

Mobile : +91 9871432046 / +91 9999329288

Email : info@jemediguard.com

Web : www.jemediguard.com

JULLUNDUR ENTERPRISES

ENDOSCOPIC INTEGRATED UNIT



JULLUNDUR ENTERPRISES proud to introduce FIRST TIME MADE IN INDIA the state of art rigid and advance COMBO UNIT (HD CAMERA + LIGHT SOURCE +FHD MONITOR) all in one, it's easy to operate and carry anywhere, HD camera give you very good crisp and clear picture quality (pixel plus chipset from Korea) as this chip is 5 mega pixel gives you very good depth of field of the picture and it comes with adjustable white balance by pressing key, also you can freeze picture whenever you want by pressing freeze key its very help full function for diagnostics, camera head design is very good use very handy and easy to operate.

Light source- 2 years of hard work from our R&D team we develop this 100 watts light source for this unit we test it for longer time to prove its stability, we use the power LED from **Germany** And control by stat of art our own design with the latest micro processor control the LED

By Safer and smart PWM technology, it gives accurate steps by 2% to 100% intensity while pressing INTENSITY control keys UP/DOWN, we have one unique function like SLEEP, after pressing this key all parameters of intensity goes to 2% when you do not want to use for a shorter time, pressing again this key it resume to intensity that you were work on, this way we can save the life span of LED.

JULLUNDUR ENTERPRISES

ENDOSCOPIC INTEGRATED UNIT

Power supply factor is very delegate and highly accurate issue for every electronics equipments, we design our own power supply to protect any of damage due to power factor.

HD .MONITOR- We use 12" FHD IPS panel from korea with the resolution of 1920*1080p

For very good picture quality you can control all the parameters from the front panel

Like color, brightness, contrast, ratio, and many more.

Construction of housing is our UNIQUE DESIGN with long lasting hinges and the heat management system, the worst part in designing a housing is a heat management system (how to exhaust the heat) to protect equipment for long time operational.

Technical Secification

- Sensor - 1/2.5" Cmos sensor
- Sensor Resolution - 7.34MP
- White balance - Yes (by pressing key)
- Signal to Noise Ratio - 52db
- Freeze - Yes (by pressing key)
- Sensitivity - 0.2 lux
- Electronic Shutter - 1/25~1/100000
- Back light control - Yes (auto)
- R>G>B gain control - Yes (by factory setting only)
- Anti glair - yes
- Ir protection - Yes (by IR cut filter)
- Lens mount - C/Cs mount
- Cable - 2.8 meters
- Gamma correction - 4.5 Degree (by factory setting)
- Synchronization - serial data interface @ 2.9Gbps
- Scanning Frequency - H - 18.8kHz V - 25 Hz
- Sleep mode - Yes (by pressing key goes to 2%)
- Display - Digital LCD display 16*2
- LED age - Yes with memory
- Fiber cable - Yes supplied 2.30 Mtrs
- Cooling system - Equipped with 3 fans to exhaust heat

FHD monitor

- Screen size - 12" full HD
- Resolution - 1080P
- Display mode - IPS
- Panel brightness - 650cd/m2
- Contrast ratio - 1000:1 NITS
- HDMI OUT - Yes (optional)
- LCD control - Yes (by pressing keys)

Input Power

- 110~240V freq 50Hz (free voltage)
- Housing Type - Metal (baked painted) with 2 smooth hinges can tilt at any of angle without any jerk.

Dimention

- (W*H*D) - 300*110*220 mm

LIGHT SOURCE

- Led (light) - 100 watts (Germany)
- Operating system - Smart micro processor based
- Intensity display - Yes (2% to 100% by steps)
- Intensity Up key - Yes
- Intensity Down key - Yes

JULLUNDUR ENTERPRISES

1568-A, G-22-23, BHAGIRATH PALACE, DELHI 110006, INDIA

Mobile : +91 9871432046 / +91 9999329288

Email : info@jemediguard.com

Web : www.jemediguard.com

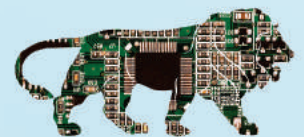

JULLUNDUR ENTERPRISES

16" ENDOSCOPIC UNIT with TROLLEY



JULLUNDUR ENTERPRISES proud to introduce **FIRST TIME MADE IN INDIA** the state of art rigid and advance **COMBO UNIT (HR CAMERA +LIGHT SOURCE+16" FHD DISPLAY)** all in one, it's easy to operate and carry anywhere, HR camera give you very good crisp and clear picture quality (CCD SONY chipset from JAPAN) as this chip is 1200TVL high resolution gives you very good depth of field of the picture and it comes with adjustable white balance by pressing key Its very help full function for diagnostics as it provides accurate colours, camera head design is very good use very handy and easy to operate.

FULL HD MEDICAL DISPLAY- Big 16" FHD- IPS gives the user good view with advantage of portability. This medical display provies1920*1080P fine pixel with 60hz fast refresh rate. Its 16.7M color depth provides wide range of color spectrum to the user with outstanding color to contrast ratio Medical endoscopy require a very specific amount of brightness to get a best image on diagnostic screen combo provides that specific level to the display,
Color

16" Endoscopic unit with Trolley

www.jemediguard.com

JULLUNDUR ENTERPRISES

16" ENDOSCOPIC UNIT with TROLLEY

Power supply factor is very delegate issue for every electronics equipments, we design our own power segment to protect any of damage due to power.

LED Light Source- Ultra bright led light source provides the user the best and bright vision with the endoscopy system we provide lens with the led light to double the power of the led without wasting any power, color temperatue of the led light source is very important as it reflects the tissue color 5600k accurate color led with CRI above 91 provides true red blood color which is very important in medical endoscopy field, this unit is equipped with digital cold led light source which is pwm controlled and work over 150khz frequency which is perfect for the camera vision with out any interruptions

Technical Secification

- Sensor - 1/3" CCD sensor
- Sensor Resolution - 1200 TV lines hi-resolution
- White balance - Yes (by pressing key)
- Signal to Noise Ratio - 52db
- Sensitivity - 0.2 lux
- Electronic Shutter Speed - 1/25~1/100000+ auto
- Back light control - Yes (auto)
- R>G>B gain control - Yes (factory setting)
- Anti glair - yes
- Ir protection - Yes (by IR cut filter)
- Lens mount - C/Cs mount
- Cable - 2.8 meters
- Gamma correction - 4.5 Degree (by factory setting)
- Synchronization - prograssive scanning
- lens - german lens for max output
- Format - digital pwm controlled
- Operating frequency - 150 khz
- LED age - 4000 hr
- Cable lenght - Yes supplied 3 mtr

FHD monitor

- Screen size - 16" full HD
- Resolution - 1920*1080P
- Display mode - IPS
- Panel brightness - 650cd/m2
- Contrast ratio - 1000:1 NITS
- OUTPUT - VIDEO OUT RAC
- LCD control - Yes (by pressing keys)

Input Power - 110~240V freq 50Hz
(free voltage) fuse protected

HOUSING

- TYPE - Metal (baked painted) with 2 smooth hinges can tilt at any of angle without any jerk.

LIGHT SOURCE

- Led (light) - ultra bright cold led
- Led make - german led module
- colour temperature - specific tone to 5600K
- CRI - specific tone CRI-91

JULLUNDUR ENTERPRISES

1568-A, G-22-23, BHAGIRATH PALACE, DELHI 110006, INDIA

Mobile : +91 9871432046 / +91 9999329288

Email : info@jemediguard.com

Web : www.jemediguard.com

JULLUNDUR ENTERPRISES

Workstation ENT TREATMENT UNIT

ENT TREATMENT UNIT Specification: -

1. Cold led light source 100 W.
2. Headlight Band stand alone with battery.
3. Instrument tray.
4. copper motor for spray + suction with diaphragm
5. Dual channel spray with suction (both can work at same time).
6. SS Instrument Tray (2)
7. Suction Machine with 2000 ML Jar auto stop suction valve.
8. Endoscope Holder 3 units
9. Gauge Peace holder for scope cleaning solution
10. Endoscopy High Resolution Camera with Sony sensor
11. full HD lcd Display High definition display 13.5" with 99% colour accuracy(800nits) brightness
12. Medicine bottle holder (CAN HOLDER)
13. 5 mm fibre optic cable 2.3 MTR IMPORTED
14. Waste can 3 units
15. GERMAN COUPLER 18/20/22MM OPTIONAL



JULLUNDUR ENTERPRISES introduces state of the art **ENT WORKSTATION** fully-loaded with features, **Diagnostic camera system** with high resolution display with gives the observer a perfect vision for the treatment, Cold Led Light Source gives 100W output with 5mm imported fibre cable gives sufficient light for camera to produce sharp + detailed image.

High resolution camera comes with balance colour correction for the true colour production. 1000tvl gives the perfect picture for the sharp detail with differentiating redness or any abnormalities
Stand alone **HEADLIGHT BATTERY OPERATED** GIVES doctor freedom to move without any fibre attached with headlight.

Dual spray can hold 2 medicine at a time for different use with out changing bottles both sprays can work at same time (advantage).

2000ml suction jar gives easy access for the replacement and drain of waste with auto stop valve.

High power led light gives ultra-bright lux with 5500k colour temperature which gives wide view to the observer in small and large cavity.

SS INSTRUMENT TRAY + CAN made of high-quality steel which allows the unit to stay rust free for a longer time

FIBRE OPTIC CABLE – 2.3 Mtr fibre optic cable with German fibre gives 100% light output from the fibre to the scope for perfect view.



JULLUNDUR ENTERPRISES

Medical Examination Led Light Source



Technical Parameters

- MCU (micro controller) based.
- PWM (pulse width modulation) signal.
- Smart intensity control feature 0-100%.
- Lighting area 1-5 sqmt (adjustable).
- Lamp height 100-180cm.
- Adaptable colour temp. (5700-6500K).
- Maximum LUX-12000 LUX Over full intensity.
- 108 Led lamps onboard for focused light.
- True tone light-perfect blend for white and yellow for true W/B.
- LED age (30,000) Hrs.
- SMPS (switching mode power supply).
- Free Input voltage 85V~240V 50 Hz.
- Working temperature: 10~70 Degree.
- Light output suitable for diagnostic.

Mechanical Parameters

- Lamp type - high performance led type lamp
- 360 degree free rotation
- Lower heat
- Material- Metal/ABS/GLASS(optical 8X)
- weight: 2.5 Kg approx

JULLUNDUR ENTERPRISES

Medical Examination Led Light Source

Product Introduction

JULLUNDUR ENTERPRISES proud to introduce EXAMINATION LED LIGHT the state of art rigid and advance micro controller <PWM> based cold led light source equipped with the power of 21-30W watts(LED's from Germany) PLPO (Peak light power output). 2 years of our hard work and research from our strong R&D team, we develop this product. Low maintains and compatible with every OPD and diagnostic , It gives 98% light to see crisp and clear picture through the zoom optical lense. This zoom optics provides the magnification of upto 8X. thus this products can be used to study purpose or treatment purpose.

- **zoom lens:** on board zoom lens helps provide the balanced magnification upto 8X without getting close to the particular field which helps the user to operate or diagnose properly.

LED : Original LED's from Cree with 108 led lamps for more light density focused.

Dual Tone Led: It comes with the dual tone led colour tempratue which helps the user to adjust the led light accordingly for the diagnostic purpose to give the user the perfect view

True White Balance :- (TWB) A perfect blend of white and yellow light emitting the right colour temperature of day light. Led colour temprature can be changed according to customer requirments, with IR remote control.

Power Segment :- designed from UL listed components and safe to use. output section completely isolated with the input 220V through octocoupler (prevents the high voltage to affe the internal circuit)

Stability :-The light weight head and stable goose neck allow easy and intuitive adjustment and keep the light exactly in the required position. The compact illumination head convenient, precise positioning, particularly in difficult application situations.

LED Thermal Management. LED illumination systems require thermal management to ensure long-term performance and product stability. Carefully selected and applied heat-diffusing materials

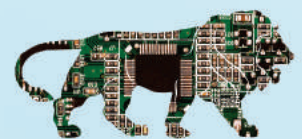

JULLUNDUR ENTERPRISES

1568-A, G-22-23, BHAGIRATH PALACE, DELHI 110006, INDIA

Mobile : +91 9871432046 / +91 9999329288

Email : info@jemediguard.com

Web : www.jemediguard.com

THE MARK OF QUALITY & CRAFTSMANSHIP



ORTHOPEDIC SURGICAL INSTRUMENTS

**The House Known For
Surgical Instruments**



JULLUNDUR ENTERPRISES

Manufacturer & Exporter Of Surgical Instruments





S.No.	PARTICULARS	Page
	IMPLANTS	
1.	HIP PROSTHESIS	15
2.	NAILS	
	INTERLOCKING NAILS	1-2
	JEWETT NAILS	16
	K-NAILS	16
	RUSH NAILS	16
	SQUAR NAILS	17
	V- NAILS	16
3.	PINS	
	DANHAM PINS	17
	KNOWLES PINS	17
	MOORE'S PINS	17
	STEINMAN PINS	17
4.	PLATES	
	CLOVERLEAF PLATES	5
	COBRA HEAD PLATES	9
	CONDYLAR PLATES	7-8
	DHS BARREL PLATES	9-10
	DCS PLATES	10
	DC PLATES	4-6
	LC-DC PLATES	5-6
	L.BUTTRES PLATES	8
	LETERAL TIBIAL HEAD BUTTRESS	7
	OSTEOTOMY PLATES	9
	RECONSTRUCTION PLATES	5-7
	STEFFEE PLATES	11
	T- BUTTRESS PLATES	7
	TUBULAR PLATES	4-5
	Y-RECONSTRUCTION PLATES	5
5.	SCREWS	
	CANCELLOUS SCREWS	12-13
	CANNULATED SCREWS	14
	CORTEX SCREWS	11-12
	DH/DC SCREWS	9
	LOCKING SCREWS	3
	MALLEOLAR SCREWS	12
	SHANZ SCREWS	20
	STEFFEE SCREWS	11
6.	STAPLES	17
7.	SPINAL SURGERY IMPLANTS	10-11
8.	WIRES	
	K-WIRES	17
	SS SUTURE WIRES	17
9.	WASHERS	12-13
10.	EXTERNAL FIXATORS	
	DISTRACTORS	22-23
	FOREAM & METECARPAL	19
	HAND FIXATORS	22-23
	ILIZAROV(RING) FIXATORS	21-22
	TUBULAR FIXATORS, FEMUR- TIBIA	18-19

S.No.	PARTICULARS	Page
11.	INSTUMENTS	
	BONE CUTTERS	29
	BONE CUTTING PUNCH	35
	BONE NIBBLERS	29
	BONE HOLDING CLAMPS, FORCEPS	27-28
	BONE PLATE BENEDS	25
	CRUTCHFIELD TONG	36
	CONDYLAR PLATES	42
	CHISELS	30
	CURRETTS	30
	CUNNULATED SCREWS	40
	DHS/DCS PLATES	41
	DRILL BITS	26
	DRILL TAPS	26
	DRILL GUIDES, SLEVES	24-25
	ELECTRIC BONE DRILL	37
	ELECTRIC PLATES SAW	38
	GOUGES	30
	HAND DRILLS	37-38
	HIP PROTHESIS	35
	HAMMERS	31
	HUDSON BRACE	37
	INTER LOCKING NAILS	43-47
	KUNTSCHER'S NAILS	34
	LEVERS	32
	OSTEOTOMES	30
	PINS	33
	PERIOSTEAL ELEVATORS	32
	PLASTER CUTTING	38
	PNEUMATIC TOURIQUETE	39
	RETRACTORS	31
	REDUCTION FORCEPS	27-28
	SKULL SURGERY	36-37
	SCREW DRIVERS	24
	SCREW BOX	39-40
	SKIN GRAFTING HANDLE	39
	SPINE SURGERY	35-36
	SQUARE NAILS	34
	STAPLES	37
	WIRES	33
12.	INSTRUMENTS SETS	
	BASIC FOR PLATES & SCREWS	40
	CANNULATED SCREWS	40
	CONDYLAR PLATES	42
	DHS/DCS PLATES	41
	INTERLOCKING NAILS FEMUR/TIBIA	43-44
	INTERLOCKING NAILS HUMERUS	46
	RECONSTRUCTION NAILS	45
	STERLIZING TUBES	47
	SCREW SET LARGE	39
	SCREW SET SMALL	40



INTRAMEDULLARY LOCKING NAILS

Two Proximal Holes

For 4.9 mm Locking Screws



Two Distal Holes

For 4.9 mm Locking Screws



Femoral Nails

Length cms	Ø 8 mm Cat. No.	Ø 9 mm Cat. No.	Ø 10 mm Cat. No.	Ø 11 mm Cat. No.	Ø 12 mm Cat. No.	Ø 13 mm Cat. No.
32	F08.32	F09.32	F10.32	F11.32	F12.32	F13.32
34	F08.34	F09.34	F10.34	F11.34	F12.34	F13.34
36	F08.36	F09.36	F10.36	F11.36	F12.36	F13.36
38	F08.38	F09.38	F10.38	F11.38	F12.38	F13.38
40	F08.40	F09.40	F10.40	F11.40	F12.40	F13.40
42	F08.42	F09.42	F10.42	F11.42	F12.42	F13.42
44	F08.44	F09.44	F10.44	F11.44	F12.44	F13.44
46	F08.46	F09.46	F10.46	F11.46	F12.46	F13.46

Two Medial / Lateral Holes

For 4.9 mm Locking Screws in (Ø9 - 12mm) Nails
For 3.9 mm Locking Screws in (Ø8 mm) Nails

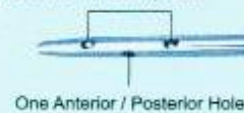

Two Medial / Lateral Holes

For 4.9 mm Locking Screws in (all sizes of Nails)



Tibial Nails

Length cms	Ø 8 mm Cat. No.	Ø 9 mm Cat. No.	Ø 10 mm Cat. No.	Ø 11 mm Cat. No.	Ø 12 mm Cat. No.
24	T08.24	T09.24	T10.24	T11.24	T12.24
26	T08.26	T09.26	T10.26	T11.26	T12.26
28	T08.28	T09.28	T10.28	T11.28	T12.28
30	T08.30	T09.30	T10.30	T11.30	T12.30
32	T08.32	T09.32	T10.32	T11.32	T12.32
34	T08.34	T09.34	T10.34	T11.34	T12.34
36	T08.36	T09.36	T10.36	T11.36	T12.36
38	T08.38	T09.38	T10.38	T11.38	T12.38
40	T08.40	T09.40	T10.40	T11.40	T12.40
42	T08.42	T09.42	T10.42	T11.42	T12.42

SUPRACONDYLAR NAILS WITH FIVE HOLES



All Five Holes

For 4.9 mm Locking Screws

Nails with Five Holes

Length cms	Ø 10mm Cat. No.	Ø 11 mm Cat. No.	Ø 12 mm Cat. No.	Ø 13 mm Cat. No.
15	SFH10.15	SFH11.15	SFH12.15	SFH13.15
21	SFH10.21	SFH11.21	SFH12.21	SFH13.21
25	SFH10.25	SFH11.25	SFH12.25	SFH13.25

SUPRACONDYLAR NAILS WITH MULTIPLE HOLES



All Holes

For 4.9 mm Locking Screws

Nails with Multiple Holes

Length cms	Ø 10mm Cat. No.	Ø 11 mm Cat. No.	Ø 12 mm Cat. No.	Ø 13 mm Cat. No.
15	SMH10.15	SMH11.15	SMH12.15	SMH13.15
21	SMH10.21	SMH11.21	SMH12.21	SMH13.21
25	SMH10.25	SMH11.25	SMH12.25	SMH13.25



One Proximal Holes
for ϕ 3.9 mm Screws

Two Distal Holes
For ϕ 2.9 mm Locking Screws (6mm) Nails
For ϕ 3.9 mm Locking Screws (7-8mm) Nails



Two Proximal Holes
for ϕ 3.9 mm Screws

Humeral Nails

Nails Dia.	Length 18cm Cat. No.	Length 20cm Cat. No.	Length 22cm Cat. No.	Length 24cm Cat. No.	Length 26cm Cat. No.	Length 28cm Cat. No.
ϕ 6 mm	H06.18	H06.20	H06.22	H06.24	H06.26	H06.28
ϕ 7 mm	H07.18	H07.20	H07.22	H07.24	H07.26	H07.28
ϕ 8 mm	H08.18	H08.20	H08.22	H08.24	H08.26	H08.28

Two Proximal Holes
for 6.5 mm Locking Screw

Two Distal Holes
For 4.9 mm Locking Screws



Proximal 8 cm ϕ up to 14mm

Femoral Reconstruction Nails (Right Leg)

Length cms	ϕ 9 mm Cat. No.	ϕ 10 mm Cat. No.	ϕ 11 mm Cat. No.	ϕ 12 mm Cat. No.	ϕ 13 mm Cat. No.
34	FR09.34	FR10.34	FR11.34	FR12.34	FR13.34
36	FR09.36	FR10.36	FR11.36	FR12.36	FR13.36
38	FR09.38	FR10.38	FR11.38	FR12.38	FR13.38
40	FR09.40	FR10.40	FR11.40	FR12.40	FR13.40
42	FR09.42	FR10.42	FR11.42	FR12.42	FR13.42
44	FR09.44	FR10.44	FR11.44	FR12.44	FR13.44
46	FR09.46	FR10.46	FR11.46	FR12.46	FR13.46

Two Proximal Holes
for 6.5 mm Locking Screw

Two Distal Holes
For 4.9 mm Locking Screws



Proximal 8 cm ϕ up to 14mm

Femoral Reconstruction Nails (Left Leg)

Length cms	ϕ 9 mm Cat. No.	ϕ 10 mm Cat. No.	ϕ 11 mm Cat. No.	ϕ 12 mm Cat. No.	ϕ 13 mm Cat. No.
34	FL09.34	FL10.34	FL11.34	FL12.34	FL13.34
36	FL09.36	FL10.36	FL11.36	FL12.36	FL13.36
38	FL09.38	FL10.38	FL11.38	FL12.38	FL13.38
40	FL09.40	FL10.40	FL11.40	FL12.40	FL13.40
42	FL09.42	FL10.42	FL11.42	FL12.42	FL13.42
44	FL09.44	FL10.44	FL11.44	FL12.44	FL13.44
46	FL09.46	FL10.46	FL11.46	FL12.46	FL13.46

Plug Screw (For Nail Head)



Cat No.	PLUG SCREW FOR I.M.L. NAILS
PSO50.01	Plug Screw For Femoral, Tibial & Recon Nails
PSO50.02	Plug Screw For Supracondylar Nails
PSO50.03	Plug Screw For Humeral Nails

LOCKING SCREWS



Locking Screw ø 4.9 mm
Self Tapping



Locking Screw ø 3.9 mm
Self Tapping



Locking Screw ø 2.9 mm
Self Tapping

Length cms	Ø 4.9 mm Cat. No.	Ø 3.9 mm Cat. No.	Ø 2.9 mm Cat. No.
16		LS 014.16	LS 013.16
18		LS 014.18	LS 013.18
20		LS 014.20	LS 013.20
22		LS 014.22	LS 013.22
24	LS 015.24	LS 014.24	LS 013.24
26	LS 015.26	LS 014.26	LS 013.26
28	LS 015.28	LS 014.28	LS 013.28
30	LS 015.30	LS 014.30	LS 013.30
32	LS 015.32	LS 014.32	LS 013.32
34	LS 015.34	LS 014.34	LS 013.34
36	LS 015.36	LS 014.36	LS 013.36
38	LS 015.38	LS 014.38	LS 013.38
40	LS 015.40	LS 014.40	LS 013.40
42	LS 015.42	LS 014.42	
44	LS 015.44	LS 014.44	
46	LS 015.46	LS 014.46	
48	LS 015.48	LS 014.48	
50	LS 015.50	LS 014.50	
52	LS 015.52	LS 014.52	
54	LS 015.54	LS 014.54	
56	LS 015.56	LS 014.56	
58	LS 015.58	LS 014.58	
60	LS 015.60	LS 014.60	
65	LS 015.65		
70	LS 015.70		
75	LS 015.75		
80	LS 015.80		
85	LS 015.85		
90	LS 015.90		
95	LS 015.95		
100	LS 015.100		
105	LS 015.105		
110	LS 015.110		
115	LS 015.115		
120	LS 015.120		



Locking Screw ø 6.5 mm
Self Tapping

Length cms	Ø 6.5 mm Cat. No.
60	LS 016.60
65	LS 016.65
70	LS 016.70
75	LS 016.75
80	LS 016.80
85	LS 016.85
90	LS 016.90
95	LS 016.95
100	LS 016.100
105	LS 016.105
110	LS 016.110
115	LS 016.115
120	LS 016.120
125	LS 016.125

BONE PLATES



**MINI FRAGMENT PLATES
FIXATION WITH 2.0MM SCREWS**

Indication : For Finger Surgery

Length mm	No. of Holes	Cat. No.
12	2	101.02
17	3	101.03
23	4	101.04
29	5	101.05
35	6	101.06
41	7	101.07
47	8	101.08



**STRAIGHT RECONSTRUCTION PLATES
FIXATION WITH 2.7MM SCREWS**

Length mm	No. of Holes	Cat. No.
16	2	103.02
24	3	103.03
32	4	103.04
40	5	103.05
48	6	103.06
56	7	103.07
64	8	103.08
72	9	103.09
80	10	103.10
88	11	103.11
96	12	103.12
112	14	103.14
128	16	103.16
144	18	103.18
160	20	103.20
176	22	103.22
192	24	103.24

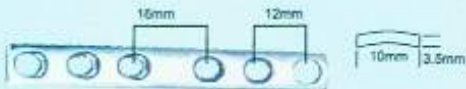

SMALL D.C. PLATES, FIXATION WITH 3.5MM SCREWS

Indication : For Ulna and Radius

Length mm	No. of Holes	Cat. No.
25	2	105.02
37	3	105.03
49	4	105.04
61	5	105.05
73	6	105.06
85	7	105.07
97	8	105.08
109	9	105.09
121	10	105.10
145	12	105.12



**DYNAMIC COMPRESSION PLATES
FIXATION WITH 2.7MM SCREWS**

Indication : For Hand Surgery and Mandibular Reconstruction

Length mm	No. of Holes	Cat. No.
20 mm	2	102.02
28 mm	3	102.03
36 mm	4	102.04
44 mm	5	102.05
52 mm	6	102.06
60 mm	7	102.07
68 mm	8	102.08
76 mm	9	102.09
84 mm	10	102.10
100 mm	12	102.12



**ONE THIRD TUBULAR PLATES
FIXATION WITH 3.5MM SCREW**

Indication : Used as Buttress Plate for Fibula, Metacarpals and Metatarsals and Fracture of Distal Humerus and Olecranon

Length mm	No. of Holes	Cat. No.
25	2	104.02
37	3	104.03
49	4	104.04
61	5	104.05
73	6	104.06
85	7	104.07
97	8	104.08
109	9	104.09
121	10	104.10
145	12	104.12

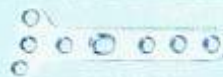

T PLATES, FIXATION WITH 3.5MM SCREWS

Indication : For Distal Radius and Lateral End of Clavicle Bone

Length mm	No. of Holes	Cat. No.
39	3	106.03
56	4	106.04
67	5	106.05
78	6	106.06

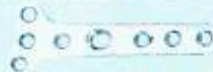

T PLATES, OBLIQUE ANGLE, FIXATION WITH 3.5MM SCREW
Indication : For the Left and Right Radius Bone

Cat No.	No. of Holes	Bone
107.03L	3 Holes	Left
107.04L	4 Holes	Left
107.05L	5 Holes	Left
107.03R	3 Holes	Right
107.04R	4 Holes	Right
107.05R	5 Holes	Right

ONE PLATES



STRAIGHT RECONSTRUCTION PLATE 3.5mm

Length mm	No. of Holes	Cat. No.
58	5	108.05
70	6	108.06
82	7	108.07
94	8	108.08
106	9	108.09
118	10	108.10
142	12	108.12
166	14	108.14
190	16	108.16
214	18	108.18
238	20	108.20

Note: Fixation with 3.5mm Cortex Screw and 4.0mm Cancellous Screw. Do not Bend more than 15



SPOON PLATE

Indication: For Anterior Tibia Border

No. of Holes	Cat No.
5	110.05
6	110.06



LIMITED CONTACT DYNAMIC COMPRESSION PLATE (LC-DCP) FIXATION WITH 3.5MM SCREWS (SMALL)

Indication: For Ulna and Radius and Mid Shaft Fracture of Clavicle Bone

Length mm	No. of Holes	Cat. No.
51	4	112.04
64	5	112.05
77	6	112.06
90	7	112.07
103	8	112.08
116	9	112.09
129	10	112.10
142	11	112.11
155	12	112.12



CLOVER LEAF PLATES, FIXATION WITH 3.5MM, 4.0MM SCREWS

Indication: For Distal Intra-Articular Tibial Fracture

Length mm	No. of Holes	Cat. No.
88	3	109.03
104	4	109.04
120	5	109.05
136	6	109.06
152	7	109.07
168	8	109.08
184	9	109.09
200	10	109.10



Y-RECONSTRUCTION PLATE

Indication: For Comminuted Fracture of Distal Humerus

No. of Holes	Cat No.
4	111.04
5	111.05
6	111.06
7	111.07
8	111.08
9	111.09



SEMI-TUBULAR PLATES, FIXATION WITH 4.5MM SCREWS

A compression effect can be achieved by eccentric positioning of the screws remote from the fracture line

Length mm	No. of Holes	Cat. No.
71	4	113.04
87	5	113.05
103	6	113.06
119	7	113.07
135	8	113.08
151	9	113.09
167	10	113.10
183	11	113.11
199	12	113.12
215	14	113.14

BONE PLATES

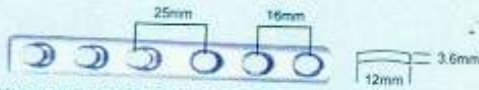

**NARROW DYNAMIC COMPRESSION PLATE
FIXATION WITH 4.5MM / 6.5MM SCREWS**

Note: As a Neutralisation and Tension Band Plate on the Tibia and Humerus

Length mm	No. of Holes	Cat. No.
39	2	114.02
55	3	114.03
71	4	114.04
87	5	114.05
103	6	114.06
119	7	114.07
135	8	114.08
151	9	114.09
167	10	114.10
183	11	114.11
199	12	114.12
215	13	114.13
231	14	114.14
247	15	114.15
263	16	114.16



**LIMITED CONTACT (LC-DCP) DYNAMIC COMPRESSION PLATE
FIXATION WITH 4.5MM SCREWS (NARROW)**

The LC-DCP holes enable compression in both directions of the longitudinal axis.

The end holes can be used for cancellous bone screws. Undercuts: for reduced vascular damage.

Indication: As a neutralisation and tension band plate on the tibia (not intended for the femur)

Length mm	No. of Holes	Cat. No.
70	4	116.04
88	5	116.05
106	6	116.06
124	7	116.07
142	8	116.08
160	9	116.09
178	10	116.10
196	11	116.11
214	12	116.12
250	14	116.14



**BROAD DYNAMIC COMPRESSION PLATE
FIXATION WITH 4.5MM/6.5MM SCREWS**

Indication: Tension Band Plate for Femur and for Pseudo-arthritis

Length mm	No. of Holes	Cat. No.
71	4	115.04
87	5	115.05
103	6	115.06
119	7	115.07
135	8	115.08
151	9	115.09
167	10	115.10
183	11	115.11
199	12	115.12
215	13	115.13
231	14	115.14
263	16	115.16
295	18	115.18



**LIMITED CONTACT DYNAMIC COMPRESSION PLATES
(LC-DCP) FIXATION WITH 4.5MM SCREWS (BROAD)**

The LC-DCP holes enable compression in both directions of the longitudinal axis.

The end holes can be used for cancellous bone screws. Undercuts: For reduced Vascular damage

Indication: As a tension band plate on the femur and for humeral pseudoarthrosis(not intended for the tibia).

Use broad plates with six or seven holes in exceptional cases only, e.g. on the humerus

Length mm	No. of Holes	Cat. No.
106	6	117.06
124	7	117.07
142	8	117.08
160	9	117.09
178	10	117.10
196	11	117.11
214	12	117.12
232	13	117.13
250	14	117.14
268	15	117.15
286	16	117.16
304	17	117.17
322	18	117.18

BONE PLATES



STRAIGHT RECONSTRUCTION PLATES
FIXATION WITH 4.5MM / 6.5MM SCREWS

Length mm	No. of Holes	Cat. No.
45	3	118.03
61	4	118.04
77	5	118.05
93	6	118.06
109	7	118.07
125	8	118.08
141	9	118.09
157	10	118.10
173	11	118.11
189	12	118.12
205	13	118.13
221	14	118.14
237	15	118.15
253	16	118.16



T' PLATES, FIXATION WITH 4.5MM / 6.5MM SCREWS

Indication: For Humeral and Tibial Head Fracture

Length mm	No. of Holes	Cat. No.
68	3	119.03
84	4	119.04
100	5	119.05
116	6	119.06
134	7	119.07
148	8	119.08
164	9	119.09

LATERAL TIBIAL HEAD BUTTRESS PLATE 4.5 mm
WITH DYNAMIC COMPRESSION HOLES AND SLOT FOR TENSION DEVICE.

For Right Leg Shaft

Length mm	No. of Holes	Cat. No.
117	5	120-05R
149	7	120-07R
181	9	120-09R
213	11	120-11R
245	13	120-13R

For Left Leg Shaft

Length mm	No. of Holes	Cat. No.
117	5	120-05L
149	7	120-07L
181	9	120-09L
213	11	120-11L
245	13	120-13L

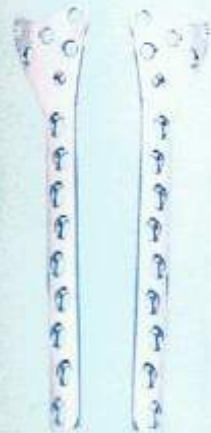

CONDYLAR BUTTRESS PLATE

Indication : For Femoral Condyl with Multiple Fragment Fracture

Left

No. of Holes	Cat. No.
7	130.07L
9	130.09L
11	130.11L
13	130.13L
15	130.15L

Right

No. of Holes	Cat. No.
7	130.07R
9	130.09R
11	130.11R
13	130.13R
15	130.15R

T-BUTTRESS PLATE (DOUBLE BEND)
FIXATION WITH 4.5MM / 6.5MM SCREWS

Indication: As buttress for Tibial Head Fracture

Length mm	No. of Holes	Cat. No.
68	3	123.03
84	4	123.04
100	5	123.05
116	6	123.06
134	7	123.07
148	8	123.08
164	9	123.09

BONE PLATES

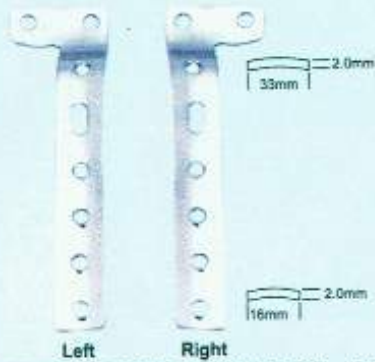

L-BUTTRESS PLATES (DOUBLE BEND) FIXATION WITH 4.5MM / 6.5MM SCREWS

Indication : As buttress for Humeral and Tibial Condyl

Left

Length mm	No. of Holes	Cat. No.
69	3	124.03L
85	4	124.04L
101	5	124.05L
119	6	124.06L

Right

Length mm	No. of Holes	Cat. No.
69	3	124.03R
85	4	124.04R
101	5	124.05R
119	6	124.06R

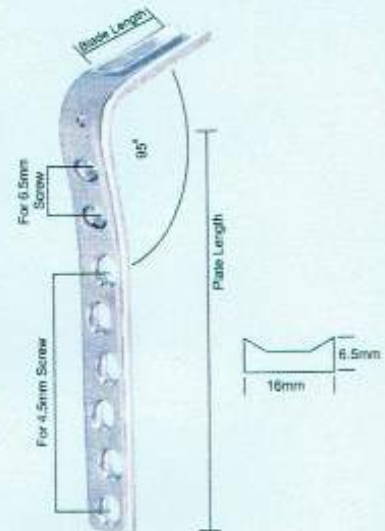

CONDYLAR PLATES 95° WITH DYNAMIC COMPRESSION HOLES

Indication: For Fracture in the Distal and Proximal Femoral Region as well as for Intertrochanteric Valgus Osteotomy

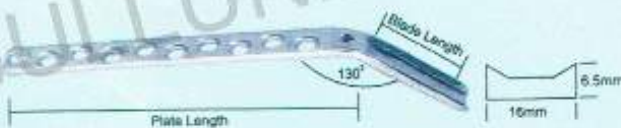

ANGLED BLADE PLATES 130° WITH DCP HOLES

Indication: For Femoral Neck and Petrochanteric Fracture

Cat. No.	No. of Holes	Blade Length mm	Plate Length mm
126.04-60	4	60	73
126.04-70	4	70	73
126.04-80	4	80	73
126.04-90	4	90	73
126.06-60	6	60	104
126.06-70	6	70	104
126.06-80	6	80	104
126.06-90	6	90	104
126.09-60	9	60	152
126.09-70	9	70	152
126.09-80	9	80	152
126.09-90	9	90	152
126.12-60	12	60	200
126.12-70	12	70	200
126.12-80	12	80	200
126.12-90	12	90	200

Cat. No.	No. of Holes	Blade Length mm	Plate Length mm
125.05-50	5	50	92
125.05-60	5	60	92
125.05-70	5	70	92
125.05-80	5	80	92
125.07-50	7	50	124
125.07-60	7	60	124
125.07-70	7	70	124
125.07-80	7	80	124
125.09-50	9	50	156
125.09-60	9	60	156
125.09-70	9	70	156
125.09-80	9	80	156
125.12-50	12	50	204
125.12-60	12	60	204
125.12-70	12	70	204
125.12-80	12	80	204
125.14-50	14	50	236
125.14-60	14	60	236
125.14-70	14	70	236
125.14-80	14	80	236
125.16-50	16	50	268
125.16-60	16	60	268
125.16-70	16	70	268
125.16-80	16	80	268
125.18-50	18	50	300
125.18-60	18	60	300
125.18-70	18	70	300
125.18-80	18	80	300

BONE PLATES

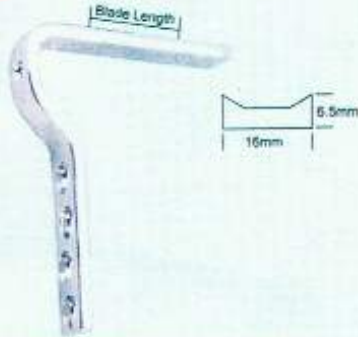

FEMORAL OSTEOTOMY PLATES FOR ADULTS

Cat. No.	Blade length mm	Displacement
127.15-40	40	15mm 90°
127.15-50	50	15mm 90°
127.15-60	60	15mm 90°
127.15-70	70	15mm 90°
127.20-50	50	20mm 90°
127.20-60	60	20mm 90°
127.20-70	70	20mm 90°
127.20-80	80	20mm 90°
128.40	40	10mm 130°
128.50	50	10mm 130°
128.60	60	10mm 130°
128.70	70	10mm 130°
128.80	80	10mm 130°
128.90	90	10mm 130°
128.100	100	10mm 130°
128.110	110	10mm 130°

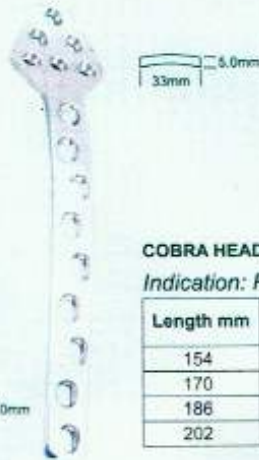

COBRA HEAD PLATE

Indication: For Hip Arthrodesis

Length mm	No. of Holes	Cat. No.
154	6	129.06
170	7	129.07
186	8	129.08
202	9	129.09



DHS / DSC SCREW

Length mm	Cat. No.
50	134.50
55	134.55
60	134.60
65	134.65
70	134.70
75	134.75
80	134.80
85	134.85
90	134.90
95	134.95
100	134.100
105	134.105
110	134.110
115	134.115
120	134.120



DHS BARREL PLATES WITH ROUND HOLES

Indication : For Pertrochantric and Intertrochantric Fracture

No. of Holes	125° Cat. No.	130° Cat. No.	135° Cat. No.	140° Cat. No.	145° Cat. No.	150° Cat. No.
2	-	-	-	-	-	-
3	-	-	131.03	-	-	-
4	131.04B	131.04C	131.04	131.04D	131.04A	131.04E
5	131.05B	131.05C	131.05	131.05D	131.05A	131.05E
6	131.06B	131.06C	131.06	131.06D	131.06A	131.06E
7	-	-	131.07	-	-	-
8	-	-	131.08	-	-	-
9	-	-	131.09	-	-	-
10	-	-	131.10	-	-	-

BONE PLATES



DHS BARREL PLATES WITH DC HOLES

Indication : For Pterochantric and Intertrochantric Fracture

No. of Holes	125° Cat. No.	130° Cat. No.	135° Cat. No.	140° Cat. No.
2	-	-	132.02	-
3	-	-	132.03	-
4	132.04A	132.04C	132.04	132.04D
5	132.05A	132.05C	132.05	132.05D
6	132.06A	132.06C	132.06	132.06D
7	-	-	132.07	-
8	-	-	132.08	-
9	-	-	132.09	-
10	-	-	132.10	-
11	-	-	132.11	-
12	-	-	132.12	-
14	-	-	132.14	-
16	-	-	132.16	-
18	-	-	132.18	-



DCS BARREL PLATE 95° WITH 'DC' HOLES

Indication: For Condylar Fractures

Length mm	No. of Holes	Cat. No.
100	6	133.06
115	7	133.07
130	8	133.08
145	9	133.09
163	10	133.10
198	12	133.12
225	14	133.14
260	16	133.16

SPINAL SURGERY IMPLANTS



HART SHILL Rectangle for Thoracic and Lumbar Spine

Length mm	Cat. No.
75	135.75
100	135.100
125	135.125
150	135.150
175	135.175
200	135.200
225	135.225
250	135.250

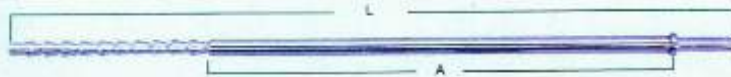

HARRINGTON DISTRACTION RODS: Designed to apply and maintain the distraction pressure required for correction

L mm	A mm	Cat. No.
121.0	25.0	137.25
148.0	50.0	137.50
170.0	75.0	137.75
200.0	100.0	137.100
225.0	125.0	137.125
250.0	150.0	137.150
275.0	175.0	137.175
300.0	200.0	137.200
325.0	225.0	137.225
350.0	250.0	137.250
375.0	275.0	137.275
400.0	300.0	137.300



HARRINGTON HOOK UPPER
CAT No. 138.01-S SHARP
CAT No. 138.01-B BLUNT



HARRINGTON HOOK LOWER
CAT No. 138.02-S SHARP
CAT No. 138.02-B BLUNT



CLIP WASHER
CAT No. 139.00

SPINAL SURGERY IMPLANTS



STEEFEE PLATE

Indication: For Lumbar Spinal Fusion

Length mm	No. of Holes	Cat. No.
75	2	141.2.0
99	2.5	141.2.5
110	3	141.3.0
137	3.5	141.3.5
148	4	141.4.0
175	4.5	141.4.5
183	5	141.5.0



STEEFEE SCREW ø 4.5 mm

Length mm	Cat. No.
32	142.32
34	142.34
36	142.36
38	142.38
40	142.40
42	142.42
44	142.44
46	142.46
48	142.48
50	142.50



STEEFEE SCREW ø 5.5 mm

Length mm	Cat. No.
32	143.32
34	143.34
36	143.36
38	143.38
40	143.40
42	143.42
44	143.44
46	143.46
48	143.48
50	143.50

CORTEX SCREWS



Length mm	Cortex ø1.5mm Cat No.	Cortex ø2mm Cat No.	Cortex ø2.7mm Cat No.
6	243.06	244.06	245.06
7	243.07		
8	243.08	244.08	245.08
9	243.09		
10	243.10	244.10	245.10
11	243.11		
12	243.12	244.12	245.12
14	243.14	244.14	245.14
16	243.16	244.16	245.16
18	243.18	244.18	245.18
20	243.20	244.20	245.20
22		244.22	245.22
24		244.24	245.24
26		244.26	245.26
28		244.28	245.28
30			245.30
32			245.32
34			245.34
36			245.36
38			245.38
40			245.40

CORTEX SCREW DIA 3.5 mm

Length mm	Cortex-3.5mm Cat. No.
10	246.10
12	246.12
14	246.14
16	246.16
18	246.18
20	246.20
22	246.22
24	246.24
26	246.26
28	246.28
30	246.30
32	246.32
34	246.34
36	246.36
38	246.38
40	246.40
42	246.42
44	246.44
46	246.46
48	246.48
50	246.50
52	246.52
54	246.54
56	246.56
58	246.58
60	246.60



2.5mm
6.0mm



CORTEX SCREWS



CORTEX SCREW DIA 4.5MM



MALLEOLAR SCREW DIA 4.5MM

Length mm	Cortex-4.5mm Cat. No.
14	247.14
16	247.16
18	247.18
20	247.20
22	247.22
24	247.24
26	247.26
28	247.28
30	247.30
32	247.32
34	247.34
36	247.36
38	247.38
40	247.40
42	247.42
44	247.44
46	247.46
48	247.48
50	247.50
52	247.52
54	247.54
56	247.56
58	247.58
60	247.60
62	247.62
64	247.64
66	247.66
68	247.68
70	247.70
72	247.72
74	247.74
76	247.76

Thread Length (L)mm	Total Length mm	Cat. No.
12	25	248.25
15	30	248.30
18	35	248.35
20	40	248.40
22	45	248.45
24	50	248.50
26	55	248.55
28	60	248.60
30	65	248.65
32	70	248.70
34	75	248.75
36	80	248.80



**CAT No. 263.01
WASHER**



**CAT No. 263.03
WASHER**

CANCELLOUS SCREWS



CANCELLOUS SCREW DIA 3.5MM



CANCELLOUS SCREW FULL THREAD DIA 4.0MM



CANCELLOUS SCREW SHORT THREAD DIA 4.0MM

Length mm	Cancellous 3.5mm Cat No.	Cancellous 4 mm Full Thread	Cancellous 4 mm Short Thread
10	249.10	250.10	251.10
12	249.12	250.12	251.12
14	249.14	250.14	251.14
16	249.16	250.16	251.16
18	249.18	250.18	251.18
20	249.20	250.20	251.20
22	249.22	250.22	251.22
24	249.24	250.24	251.24
26	249.26	250.26	251.26
28	249.28	250.28	251.28
30	249.30	250.30	251.30
35	249.35	250.35	251.35
40	249.40	250.40	251.40
45	249.45	250.45	251.45
50	249.50	250.50	251.50
55	249.55	250.55	251.55
60	249.60	250.60	251.60
65	-	250.65	251.65
70	-	250.70	251.70

PACKING OF SCREWS

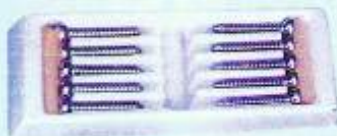

4.5mm

PACKING OF SCREWS

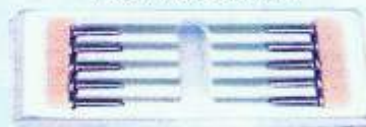

3.5mm



CANCELLOUS SCREWS

CANCELLOUS SCREW
DIA 6.5MM
16 mm Thread



CANCELLOUS SCREW
DIA 6.5 MM
32 mm Thread



CANCELLOUS SCREW
DIA 6.5MM
Full Thread



Length mm	16 mm Thread Cat No.	32 mm Thread Cat No.	Full Thread Cat No.
25	252.25	-	254.25
30	252.30	-	254.30
35	252.35	-	254.35
40	252.40	253.40	254.40
45	252.45	253.45	254.45
50	252.50	253.50	254.50
55	252.55	253.55	254.55
60	252.60	253.60	254.60
65	252.65	253.65	254.65
70	252.70	253.70	254.70
75	252.75	253.75	254.75
80	252.80	253.80	254.80
85	252.85	253.85	254.85
90	252.90	253.90	254.90
95	252.95	253.95	254.95
100	252.100	253.100	254.100
105	252.105	253.105	254.105
110	252.110	253.110	254.110
115	252.115	253.115	254.115
120	252.120	253.120	254.120



CAT No. 263.02

WASHER

For Large Cancellous Screws

CANNULATED SCREWS

CANNULATED SCREW
ø 4.0 mm x Short Thread



Head 6mm
1.25mm
Cannulation

CANNULATED SCREW
ø 4.5 mm x Short Thread



Head 8mm
1.75mm
Cannulation

CANNULATED SCREW
ø 7 mm x 32 mm Thread



Head 8mm
2.2mm
Cannulation

CANNULATED SCREW
ø 7 mm x 16 mm Thread



Length mm	Short Thread ø 4.0 mm Cat No.	Short Thread ø 4.5 mm Cat No.
12	256.12	-
14	256.14	-
16	256.16	-
18	256.18	-
20	256.20	257.20
22	256.22	257.22
24	256.24	257.24
26	256.26	257.26
28	256.28	257.28
30	256.30	257.30
32	256.32	257.32
34	256.34	257.34
36	256.36	257.36
38	256.38	257.38
40	256.40	257.40
42	256.42	257.42
44	256.44	257.44
46	256.46	257.46
48	256.48	257.48
50	256.50	257.50
52	256.52	257.52
54	256.54	257.54
56	256.56	257.56
58	256.58	257.58
60	256.60	257.60
62	256.62	257.62
64	256.64	257.64
66	256.66	257.66
68	256.68	257.68
70	256.70	257.70
72	256.72	257.72
74	256.74	257.74

Length mm	ø 7 mm x 32 mm Cat No.	ø 7 mm x 16 mm Cat No.
30	-	258.30
35	-	258.35
40	259.40	258.40
45	259.45	258.45
50	259.50	258.50
55	259.55	258.55
60	259.60	258.60
65	259.65	258.65
70	259.70	258.70
75	259.75	258.75
80	259.80	258.80
85	259.85	258.85
90	259.90	258.90
95	259.95	258.95
100	259.100	258.100
105	259.105	258.105
110	259.110	258.110
115	259.115	258.115
120	259.120	258.120
125	259.125	258.125
130	259.130	258.130

HIP PROSTHESIS

Indication : Used as Head replacement arthroplasty



BIPOLAR HIP PROSTHESIS XL (Non-Fenestrated)



BIPOLAR HIP PROSTHESIS XL (Fenestrated)

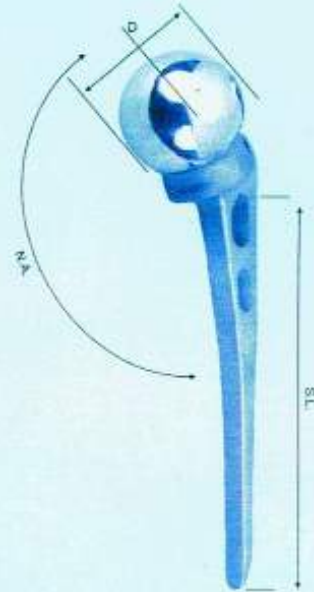

AUSTIN MOORE HIP PROSTHESIS XL

Cat. No.	Head Dia-mm (D)
305-NF-37	37
305-NF-39	39
305-NF-41	41
305-NF-43	43
305-NF-45	45
305-NF-47	47
305-NF-49	49
305-NF-51	51
305-NF-53	53
305-NF-55	55

Cat. No.	Head Dia-mm (D)
305-F-37	37
305-F-39	39
305-F-41	41
305-F-43	43
305-F-45	45
305-F-47	47
305-F-49	49
305-F-51	51
305-F-53	53
305-F-55	55

Cat. No.	Head Dia-mm (D)	Stem Length mm(S.L.)	Neck Angle (N.A.)
309.37	37	135	135°
309.39	39	135	135°
309.41	41	140	135°
309.43	43	140	135°
309.45	45	140	135°
309.47	47	140	135°
309.49	49	150	135°
309.51	51	150	135°
309.53	53	150	135°
309.55	55	150	135°



THOMPSON HIP PROSTHESIS XL

Cat. No.	Head Dia mm	Stem Length mm
310.37	37.0	137
310.39	39.0	137
310.41	41.0	137
310.43	43.0	137
310.45	45.0	137
310.47	47.0	137
310.49	49.0	137
310.51	51.0	137
310.53	53.0	137
310.55	55.0	137



CONVENTIONAL IMPLANTS



JEWETT NAIL PLATE
NAIL LENGTH 50 MM TO 100 MM ANGLE 120°, 125°, 135°, 140°

Indication : For Trochantric Fracture and Neck Femur Fracture

Cat. No.	No. of Hole
314.03	3
314.04	4
314.05	5
314.06	6
314.07	7
314.08	8
314.09	9
314.10	10
314.12	12



KUNTCHER "V" NAIL FOR TIBIA

Cat. No.	Dia mm	Length cm
321.06	6.0	15 TO 40 1cm Diff
321.07	7.0	15 TO 40 1cm Diff
321.08	8.0	15 TO 40 1cm Diff
321.09	9.0	15 TO 40 1cm Diff
321.10	10	15 TO 40 1cm Diff
321.11	11	15 TO 40 1cm Diff



"L" RIGHT ANGLED BLADE PLATE 90° Blade 50 mm to 80 mm

Cat. No.	No. of Hole
315.03	3
315.04	4
315.05	5
315.06	6
315.07	7
315.08	8
315.09	9
315.10	10
315.12	12



RUSH NAIL (HOOK INTRAMEDULLARY) FOR HUMERUS

Cat. No.	Dia mm	Length cm
322.20	2.0	6 TO 10 1cm Diff
322.25	2.5	10 TO 25 1cm Diff
322.30	3.0	10 TO 25 1cm Diff
322.35	3.5	10 TO 25 1cm Diff
322.40	4.0	20 TO 40 1cm Diff
322.50	5.0	20 TO 40 1cm Diff
322.60	6.0	20 TO 40 1cm Diff

GARDEN LOW ANGLE SCREWS
DIA 8.0MM

Cat. No.	Length mm
320.60	60
320.65	65
320.70	70
320.75	75
320.80	80
320.85	85
320.90	90
320.95	95
320.100	100



KUNTSCHER CLOVER LEAF NAIL FOR FEMUR (K-NAIL)

Cat. No.	Dia mm	Length cm
323.06	6.0	20 TO 40 1cm Diff
323.07	7.0	20 TO 40 1cm Diff
323.08	8.0	24 TO 44 1cm Diff
323.09	9.0	24 TO 44 1cm Diff
323.10	10	24 TO 44 1cm Diff
323.11	11	24 TO 44 1cm Diff
323.12	12	24 TO 44 1cm Diff
323.13	13	24 TO 44 1cm Diff

SQUARE NAIL FOR RADIUS

Cat. No.	Dia mm	Length cm
324.20R	2.0	16 TO 30 1cm Diff
324.25R	2.5	16 TO 30 1cm Diff
324.30R	3.0	16 TO 30 1cm Diff
324.35R	3.5	16 TO 30 1cm Diff
324.40R	4.0	16 TO 30 1cm Diff

STEINMEN PINS

Cat. No.	Dia mm	Length cm
326.30	3.0	16 TO 24 1cm Diff
326.35	3.5	16 TO 24 1cm Diff
326.40	4.0	16 TO 24 1cm Diff
326.45	4.5	16 TO 24 1cm Diff
326.50	5.0	16 TO 24 1cm Diff

SQUARE NAIL FOR ULNA

Cat. No.	Dia mm	Length cm
324.20U	2.0	16 TO 30 1cm Diff
324.25U	2.5	16 TO 30 1cm Diff
324.30U	3.0	16 TO 30 1cm Diff
324.35U	3.5	16 TO 30 1cm Diff
324.40U	4.0	16 TO 30 1cm Diff

DANHAM PINS (CENTRALLY THREADED PIN)

Cat. No.	Dia mm	Length cm
327.40	4.0	22.5
327.45	4.5	22.5
327.50	5.0	22.5



KNOWLES PINS

Cat. No.	Dia mm	Length cm
328.3	3.0	50 TO 130 5 mm Diff
328.4	4.0	50 TO 130 5 mm Diff



KRISCHNER WIRE (K-WIRE) RUBLE ENDED TROOCAR POINT

Cat. No.	Dia mm	Length cm
325.10	1.0	15 TO 24 1cm Diff
325.15	1.5	15 TO 24 1cm Diff
325.20	2.0	15 TO 24 1cm Diff
325.25	2.5	15 TO 24 1cm Diff
325.30	3.0	15 TO 24 1cm Diff

MOORE'S PIN WITH 2 NUTS - DIA 3.0MM

Cat. No.	Dia mm	Length cm
329.00	3.0	50 TO 150 5 mm Diff



STAINLESS STEEL SUTURE WIRES (SS. WIRES)

Cat. No.	Size SWG
330.16	16
330.18	18
330.20	20
330.22	22
330.24	24
330.26	26
330.28	28
330.30	30

THREAD KIRCHNER WIRES

Cat. No.	Size
335.10	1.0mmx 15 cm
335.15	1.5mmx 15 cm
335.20	2.0mmx 15 cm
335.25	2.5mmx 15 cm



U-TYPE STAPLES

Lenght mm	ø 1.5 mm Cat. No.	ø 2.0 mm Cat. No.	ø 2.5 mm Cat. No.	ø 3.0 mm Cat. No.
12.0	331.1512	331.2012	331.2512	331.3012
18.0	331.1518	331.2018	331.2518	331.3018
24.0	331.1524	331.2024	331.2524	331.3024
36.0	331.1536	331.2036	331.2536	331.3036

COVENTRY STAPLES

Cat. No.	Size
332.S	Small
332.M	Medium
332.L	Large



EXTERNAL FIXATORS (TUBULAR EXTERNAL FIXATORS FOR TIBIA, FEMUR, HUMERUS)



Cat. No. 401.01
SINGLE PIN CLAMP



Cat. No. 402.00
DOUBLE PIN CLAMP



Cat. No. 403.00
OPEN CLAMP



Cat. No. 404.00
CONNECTING CLAMP



Cat. No. 405-S
TWIN CLAMP (STRAIGHT)



Cat. No. 405-C
TWIN CLAMP (CURVED)



Cat. No. 406.00
TUBE TO TUBE CLAMP



Cat. No. 410.00
**COMPRESSION/DISTRACTION
DEVICE**



Cat. No. 407.00
TRANSVERSE CLAMP



Cat. No. 412.00
TRIPLE TROCAR WITH HANDLE 100MM



Cat. No. 411.00
SCHANZ SCREW INTRODUCER



Cat. No. 408.00
SPAMMER 11 MM

CONNECTING ROD, 5MM DIA

Cat. No.	Length cm
415.15	15
415.20	20



TUBULAR ROD

Length mm	100	125	150	200	250	300	350	400	450	500
Cat. No.	413.10	413.12	413.15	413.20	413.25	413.30	413.35	413.40	413.45	413.50



SEMI CIRCULAR TUBULAR ROD

Cat No.	Size
414-S	SMALL
414-L	LARGE

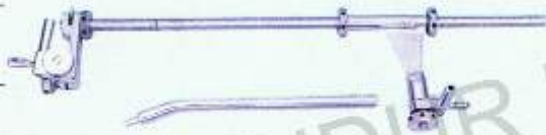

Cat. No. 418.00
FEMORAL DISTRACTOR (Large)

CONNECTING ROD ø4MM

Cat No.	Length mm
423.10	100
423.15	150
423.20	200
423.25	250
423.30	300

EXTERNAL FIXATORS FOR FOREARM AND METACARPAL



Cat. No. 419.01
Clamp For Forearm 4.0mm x 3.5mm



Cat. No. 419.02
Clamp For Metacarpal 4.0mm x 2.5mm



Cat. No. 422
TRIPLE TROCAR (50mm)



Cat. No. 468.07
DISTRACTION / COMPRESSION ASSEMBLY
Indication: For Malunited Fractures of Distal Radius / Wrist Joint



Cat. No. 420
SPANNER (8mm)

SCHANZ SCREWS(FRONT THREADED)

Cat. No.	Thread Dia mm	Thread Length mm	Total Length mm
425.01	2.5	14	100
425.02	3.5	16	125

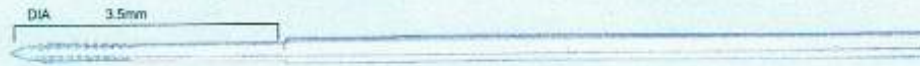

Cat. No.	Thread Dia mm	Thread Length mm	Total Length mm
425.03	4.0 x 3.5	18	125
425.04	4.0 x 3.5	18	150

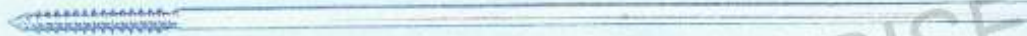

Cat. No.	Thread Dia mm	Thread Length mm	Total Length mm
425.05.18	4.5	18	175
425.05.25	4.5	25	200
425.05.32	4.5	32	225

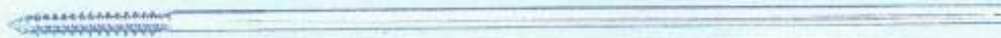

Cat. No.	Thread Dia mm	Thread Length mm	Total Length mm
425.06.25	5.0	25	175
425.06.32	5.0	32	200
425.06.50	5.0	50	225



Cat. No.	Thread Dia mm	Thread Length mm	Total Length mm
426.01	6.5	16	225
426.02	6.5	32	225

EXTERNAL FIXATORS ILIZAROV (RING FIXATOR)



HALF RINGS

Cat. No.	Size
427.10	100
427.12	120
427.14	140
427.16	160
427.18	180
427.20	200
427.22	220
427.24	240



TELESCOPIC RODS

Cat. No.	Size
436.10	100
436.12	125
436.15	150
436.20	200
436.25	250
436.30	300



POSTS FEMALE

Cat. No.	Holes
437.02	2
437.03	3
437.04	4



POSTS MALE

Cat. No.	Holes
438.02	2
438.03	3
438.04	4



5/8 RINGS

Cat. No.	Size
428.10	100
428.12	120
428.14	140
428.16	160
428.18	180
428.20	200
428.22	220
428.24	240



Cat. No. 439.01 HINGES FEMALE



Cat. No. 439.02 HINGES MALE



SHORT CONNECTION PLATES

Cat. No.	Size
440.02	2
440.03	3
440.04	4
440.05	5
440.06	6
440.07	7
440.08	8



TWISTED PLATE

Cat. No.	Holes
441.02	2
441.03	3
441.04	4



ITALIAN FEMORAL ARCHES

Cat. No.	Size	Angle
429.S	Small	90°
430.S	Small	120°
429.L	Large	90°
430.L	Large	120°

ILIZAROV WIRES

Cat. No.	
444.15	One End Baynot Other End Trocar Point 1.5mm
444.18	One End Baynot Other End Trocar Point 1.8mm

Cat. No.	
445.15	Olive Wire Baynot Point 1.5mm
445.18	Olive Wire Baynot Point 1.8mm

THREADED RODS

Cat. No.	Size mm
434.07	75
434.10	100
434.12	125
434.15	150
434.20	200
434.25	250
434.30	300
434.35	350
434.40	400



Cat. No. 446 Ring Connecting Bolts



Cat. No. 447.01 Wire Fixation Bolt Carinated



Cat. No. 447.02 Wire Fixation Bolts Slotted



Cat. No. 448.00 Conical Washer Couple



Cat. No. 449.00 Connection Bolts



Cat. No. 450.00 Nut 10mm

EXTERNAL FIXATORS ILIZAROV (RING FIXATOR)



Cat. No. 452.01
SLOTTED WASHER



Cat. No. 452.02
SPACING WASHER



Cat. No. 453.00
REPOFIX DEVICES



WRENCH QUBC

Cat. No.	Holes
454.01	1
454.02	2
454.03	3



Cat. No. 455.00
SPANNER 10 mm



Cat. No. 456.00
BOX SPANNER 10 mm



Cat. No. 432.00
SCHANZ PIN FIXATION BOLTS



Cat. No. 433.00
OBLIQUE SUPPORT



Cat. No. 457.00
WIRE TENSIONER



CORTICOTOME

Cat. No.	Size mm
430.05	5
430.10	10
430.15	15
430.20	20

DISTRACTORS FOR HAND FIXATORS



DISTRACTORS-FISH MOUTH - DOUBLE HOLE - 4.0MM

Cat. No.	Length mm
458.75	75
458.100	100
458.150	150



DISTRACTORS-FISH MOUTH - DOUBLE HOLE - 6.0MM

Cat. No.	Length mm
459.150	150
459.200	200
459.250	250
459.300	300



DISTRACTORS-FISH MOUTH - SWIVEL - 4.0MM

Cat. No.	Length mm
460.100	100
460.150	150



DISTRACTORS-FISH MOUTH - SWIVEL - 6.0MM

Cat. No.	Length mm
461.150	150
461.200	200
461.250	250
461.300	300
461.350	350



HAND FIXIATORS



DISTRACTOR SINGLE HOLE 4.0MM

Cat. No.	Length mm
462.50	50
462.75	75



DISTRACTOR DOUBLE HOLE 4.0MM

Cat. No.	Length mm
463.75	75
463.100	100
463.150	150



DISTRACTOR DOUBLE HOLE 6.0 MM

Cat. No.	Length mm
464.150	150
464.200	200
464.250	250
464.300	300



Cat. No. 466.01
LINK JOINTS FOR 1.5 & 2.0MM WIRES



Cat. No. 466.02
LINK JOINTS FOR 2.5MM WIRES



Cat. No. 467.02
LINK JOINTS FOR 3.0MM WIRES

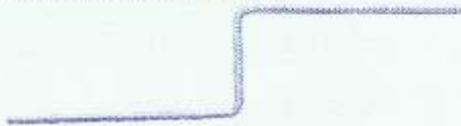

Cat. No. 466.03
Z ROD SERRATED DIA 2.5MM
Cat. No. 467.03
Z ROD SERRATED DIA 3.0MM



Cat. No. 466.04
L ROD SERRATED DIA 2.5MM
Cat. No. 467.04
L ROD SERRATED DIA 3.0MM

STRAIGHT RODS SERRATED

Cat. No. Ø 2.5mm	Length mm	Cat. No. Ø 3.0mm	Length mm
466.05	75	467.05	75
466.06	100	467.06	100
466.07	150	467.07	150
466.08	200	467.08	200
		467.09	250

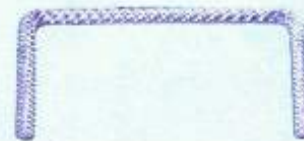

Cat. No. 466.09
U ROD SERRATED DIA 2.5MM
Cat. No. 467.10
U ROD SERRATED DIA 3.0MM

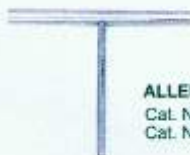

ALLEN KEY WITH T- HANDLE
Cat. No. 466.12 - 2.5MM
Cat. No. 467.14 - 3.0MM



Cat. No. 468.02
BAIXIAL UNIPLANER LINK JOINT



Cat. No. 468.03
HINGES JOINT



Cat. No. 468.04
SPANNER-8MM
Cat. No. 468.05
SPANNER-10MM

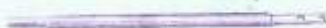

Cat. No. 468.06
ROD BENDER (PAIR)



Cat. No. 468.01
INDEPENDENT CONTROL LINK JOINT



INSTRUMENTS FOR PLATES & SCREWS



Cat. No. 641.00
Lane Screw Driver



Cat. No. 644.01
Universal Fibre Handle For
Quick Coupling Screw Driver Shaft



Cat. No. 644.02
Lanes Screw Driver with Quick
Coupling Shaft for slotted Screws



Cat. No. 644.03
Hexagonal Screw Driver with Quick
Coupling Shaft for 3.5mm Screw



Cat. No. 644.04
Hexagonal Screw Driver with Quick
Coupling Shaft for 4.5mm Screw



Cat. No. 651.02
Hexagonal Screw Driver Tip 1.5mm
with sleeve for 2.0mm Screw

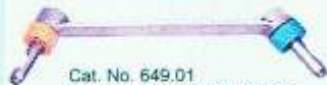

Cat. No. 649.01
Neutral & Load Drill Guide
For 3.5mm Screw

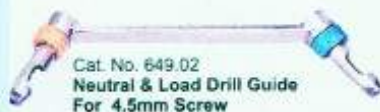

Cat. No. 649.02
Neutral & Load Drill Guide
For 4.5mm Screw



Cat. No. 650.00
Pointed Drill Guide with
insert Sleeve 4.5/3.2mm



Cat. No. 642.01
Hexagonal Screw Driver with Self Holding
Sleeve Tip 3.5mm For 4.5mm Screws



Cat. No. 642.02
Hexagonal Screw Driver with Self Holding
Sleeve Tip 2.5mm For 3.5mm Screws



Cat. No. 651.03
Hexagonal Screw Driver
Tip 3.5mm For 4.5mm Screws



Cat. No. 651.01
Hexagonal Screw Driver
Tip 2.5mm For 3.5mm Screws



Cat. No. 647.02
Hollow mill For Removal of Drill Bits 2.0, 2.7mm

Cat. No. 647.03
Hollow mill For Removal of 3.5mm Screws

Cat. No. 647.04
Hollow mill For Removal of 4.5mm & 6.5mm Screws

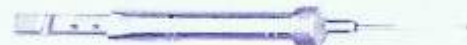

Cat. No. 652.01
Depth Gauge Small For 3.5mm Screw



Cat. No. 652.02
Depth Gauge Large For 4.5mm & 6.5mm Screw



Cat. No. 654.00
Screw Holding Forcep Self locking

INSTRUMENTS FOR PLATES & SCREW

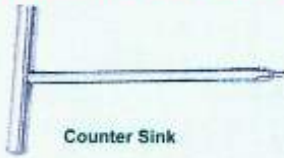

Counter Sink

Cat. No.	Size mm
655.06	6.0mm
655.08	8.0mm



Drill Sleeve

Cat. No.	Size mm
656.20	2.0mm
656.25	2.5mm
656.32	3.2mm



Tap Sleeve

Cat. No.	Size mm
656.35	3.5mm
656.45	4.5mm



Drill & Tap Sleeve Combined

Cat. No.	Size mm
657.01	Drill 2.5mm Tap 3.5mm
657.02	Drill 3.2mm Tap 4.5mm



Cat. No. 658.01
Plate Bender (Pair) Small



Cat. No. 658.02
Plate Bender (Pair) Large



Cat. No. 665.00
Goniometer S.S



Cat. No. 659.00
Plate Bending Press

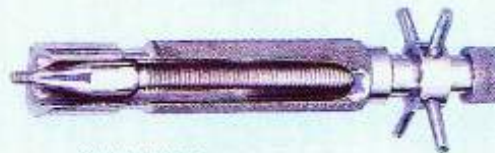

Plate Bender For Reconstruction Plates

Cat. No.	Size
660.01	For 2.7mm Plates
660.02	For 3.5mm Plates
660.03	For 4.5mm Plates



Cat. No. 661.00
Plate Bender Roller type



Cat. No. 662.00
Introducer/Extractor for Jewett Nail Plate



Cat. No. 663.00
Angle Guide Variable



Cat. No. 664.00
Muller Compression Clamp with spanner

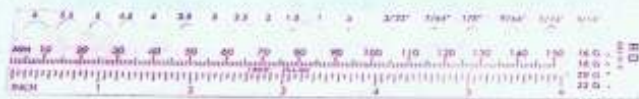

Cat. No. 665.10
Scale with Gauge

INSTRUMENTS FOR PLATES & SCREW

DRILL BITS (S.S) WITH NON- COUPLING END (PLAIN)

Length mm	DIA.mm	Cat. No.
75	1.5	666.15
100	2.0	666.20
125	2.5	666.25
125	2.7	666.27
125	3.2	666.32
125	3.5	666.35
125	4.5	666.45

DRILL BITS (S.S) WITH NON- COUPLING END (PLAIN)

Length mm	DIA.mm	Cat. No.
200	2.5	666.25L
200	3.2	666.32L
200	3.5	666.35L
200	4.0	666.40L
200	4.5	666.45L

DRILL BITS (S.S) WITH COUPLING END.)

Length mm	DIA.mm	Cat. No.
100	2.0	667.20
125	2.5	667.25
125	2.7	667.27
125	3.2	667.32
125	3.5	667.35
125	4.5	667.45

DRILL BITS (S.S) WITH COUPLING END.)

Length mm	DIA.mm	Cat. No.
200	2.5	667.25L
200	3.2	667.32L
200	3.5	667.35L
200	4.5	667.45L



DRILL TAP WITH HANDLE
 Cat. No. 668.20 DIA.2.0mm
 Cat. No. 668.27 DIA.2.7mm



DRILL TAP WITH HANDLE (For Cortex)
 Cat. No. 668.35 DIA.3.5mm



DRILL TAP WITH HANDLE (For Cancellous)
 Cat. No. 668.35c DIA.3.5mm
 Cat. No. 668.40c DIA.4.0mm

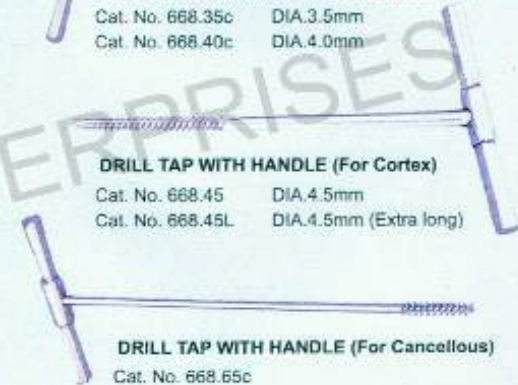

DRILL TAP WITH HANDLE (For Cortex)
 Cat. No. 668.45 DIA.4.5mm
 Cat. No. 668.45L DIA.4.5mm (Extra long)

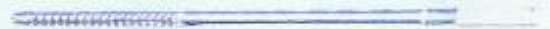

DRILL TAPS WITH COUPLING END
 Cat. No. 669.20 DIA. 2.0mm
 Cat. No. 669.27 DIA. 2.7mm



DRILL TAP WITH COUPLING END (FOR CORTEX)
 Cat. No. 669.35 DIA. 3.5mm



DRILL TAP WITH COUPLING END (FOR CANCELLOUS)
 Cat. No. 669.35c DIA. 3.5mm
 Cat. No. 669.40c DIA. 4.0mm



DRILL TAP WITH HANDLE (FOR CORTEX)
 Cat. No. 669.45 DIA. 4.5mm
 Cat. No. 669.45L DIA. 4.5mm(extra long)

BONE HOLDING INSTRUMENTS



Cat. No. 690.01 Bone & Plate Holding Forceps for Forearm
 Cat. No. 690.02 Bone & Plate Holding Forceps for Tibia
 Cat. No. 690.03 Bone & Plate Holding Forceps for Femur



SELF CENTERING BONE HOLDING FORCEPS

Cat. No.	Length mm
700.01	150
700.02	190
700.03	240
700.04	280

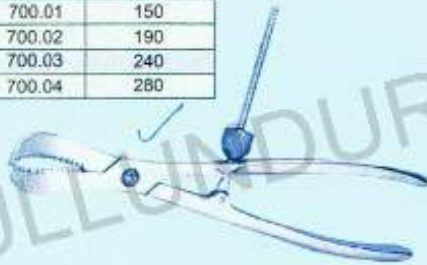

REDUCTION FORCEPS (SERRATED)

Cat. No.	Length mm
701.01	140
701.02	180
701.03	210
701.04	240

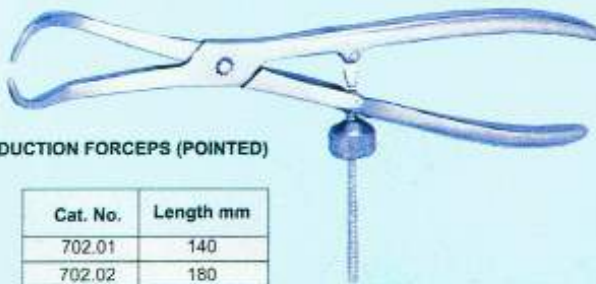

REDUCTION FORCEPS (POINTED)

Cat. No.	Length mm
702.01	140
702.02	180
702.03	210
702.04	240



PELVIC REDUCTION FORCEPS

Cat. No.	Length mm
702.06	190
702.07	250
702.08	400



PATELLA HOLDING FORCEPS FOUR PRONG

Cat. No.	Length mm
703.01	175
703.02	210
703.03	240



PATELLA HOLDING FORCEPS THREE PRONG

Cat. No.	Length mm
703.04	210
703.05	240



Cat. No. 704.S, Straight - 210mm Fibula Holding Forceps



Cat. No. 704.C Curved - 210mm Fibula Holding Forceps



Cat. No. 705.00 Malleolar forceps-210mm

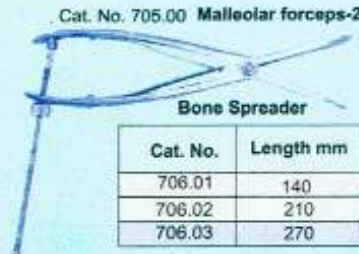

Bone Spreader

Cat. No.	Length mm
706.01	140
706.02	210
706.03	270

ONE HOLDING INSTRUMENTS



Cat. No. 707.00
Tibial Edge Holding Forceps



Cat. No. 708.S Bone Plate Holding Forceps for Small DCP
Cat. No. 708.N Bone Plate Holding Forceps for Narrow DCP
Cat. No. 708.B Bone Plate Holding Forceps for Broad DCP



Cat. No. 709.01 Lowman's Bone Holding Clamp 3 1/2"
(For Metacarpal Phalanges Mini)



Cat. No. 709.02 Lowman's Bone Holding Clamp 5"
(For Forearm Bones Small)

Cat. No. 709.03 Lowman's Bone Holding Clamp 6"
(For Humerus Medium)

Cat. No. 709.04 Lowman's Bone Holding Clamp 8"
(For Femur Tibia Large)

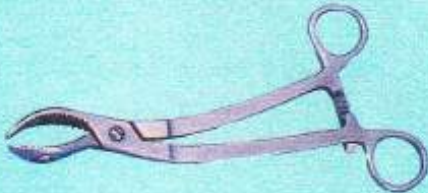

Cat. No. 710.00 Burn Bone Holding Forceps



Lane Bone Holding Forceps
without Ratchet

Cat. No.	Size
711.08	200mm
711.10	250mm
711.12	300mm

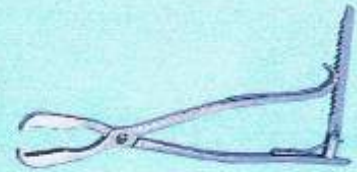

Lane Bone Holding Forceps
with Ratchet

Cat. No.	Size
712.08	200mm
712.10	250mm
712.12	300mm



Hay Grooves Bone Holding Forceps

Cat. No.	Size
713.08	200mm
713.10	250mm
713.12	300mm



Ferguson's or Lion Bone Holding Forceps

Cat. No.	Size
714.06	150mm
714.07	175mm
714.08	200mm
714.09	225mm



Pelvic Reduction Forceps For 3.5, 4.5mm Screws

Cat. No.	Size
702.09	200mm
702.10	250mm



Cat. No. 702.12 Pelvic Reduction Forceps Length - 400mm



Bone Cutting Forceps (Single Action)

Cat. No.	Size
716.06	150mm
716.07	175mm
716.08	200mm



Bone Cutting Forceps (Double Action)

Cat. No.	Size
717.07	175mm
717.08	200mm



Cat. No. 718.09 Bone Cutting Forceps (Double Action) 240mm



Cat. No. 719.00 Tuder Edward Bone Cutting Forceps 270mm



Bone Nibbler (Single Action)

Cat. No.	Size
720.06	150mm
720.07	175mm
720.08	200mm



Bone Nibbler (Double Action) Straight

Cat. No.	Size
721.07	175mm
721.08	200mm
722.09S	240mm



**Bone Nibbler (Double Action) 240mm Curved
Cat. No. 722.09C**



Cat. No. 722.09A Bone Nibbler (Double Action) 240mm Angular



Cat. No. 723.00 Finger Saw



Cat. No. 724.00 Amputation Saw



Cat. No. 725.00 Doyen Rib Shears

CHISELS, GOUGES, OSTEOTOMES BONE CURETT



Osteotome with Fibre Handle- Straight

Cat.No.	Size	Cat.No.	Size
726.05S	5mm	726.16S	16mm
726.08S	8mm	726.18S	18mm
726.10S	10mm	726.20S	20mm
726.12S	12mm	726.25S	25mm
726.14S	14mm	726.30S	30mm



Osteotome with Steel Handle

Cat.No.	Size	Cat.No.	Size
729.06	6mm	729.15	15mm
729.08	8mm	729.18	18mm
729.10	10mm	729.20	20mm
729.12	12mm	729.24	24mm



Osteotome with Fibre Handle- Curved

Cat.No.	Size	Cat.No.	Size
726.05C	5mm	726.16C	16mm
726.08C	8mm	726.18C	18mm
726.10C	10mm	726.20C	20mm
726.12C	12mm	726.25C	25mm
726.14C	14mm	726.30C	30mm



Chisel with Steel Handle

Cat.No.	Size	Cat.No.	Size
730.06	6mm	730.15	15mm
730.08	8mm	730.18	18mm
730.10	10mm	730.20	20mm
730.12	12mm	730.24	24mm



Chisels with Fibre Handle

Cat.No.	Size	Cat.No.	Size
727.05	5mm	727.20	20mm
727.10	10mm	727.25	25mm
727.15	15mm	727.30	30mm



Gouges with Steel Handle

Cat.No.	Size	Cat.No.	Size
731.06	6mm	731.15	15mm
731.08	8mm	731.18	18mm
731.10	10mm	731.20	20mm
731.12	12mm	731.24	24mm



Gouge with Fibre Handle- Straight

Cat.No.	Size	Cat.No.	Size
728.05S	5mm	728.16S	16mm
728.08S	8mm	728.18S	18mm
728.10S	10mm	728.20S	20mm
728.12S	12mm	728.25S	25mm
728.14S	14mm	728.30S	30mm

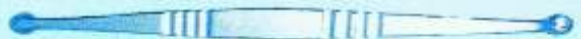

Bone Curette - Double Ended

Cat No.	Size
733.01/04	4 mm x 6 mm
733.01/06	6 mm x 9 mm
733.01/09	9 mm x 12 mm



Gouge with Fibre Handle- Curved

Cat.No.	Size	Cat.No.	Size
728.05C	5mm	728.16C	16mm
728.08C	8mm	728.18C	18mm
728.10C	10mm	728.20C	20mm
728.12C	12mm	728.25C	25mm
728.14C	14mm	728.30C	30mm



Bone Curette with Fibre Handle

Cat.No.	Size	Cat.No.	Size
733.02/03	3mm	733.02/08	8mm
733.02/04	4mm	733.02/10	10mm
733.02/05	5mm	733.02/12	12mm
733.02/06	6mm		

BONE HAMMERS - RETRACTORS



Bone Hammers with Fibre Handle

Cat. No.	Size
732.01	350 Gms.
732.02	500 Gms.
732.03	700 Gms.



Cat. No. 732.04 Bone Hammers Teflon Faced



Cat. No. 732.05 1 Pound
Cat. No. 732.06 2 Pounds

Bone Hammers with S.S Handle



Cat. No. 734.00 Bristow Retractor



Lagenback Retractor

Cat. No.	Size
734.01S	Small
734.01M	Medium
734.01L	Large



Volkman's Retractor

Cat. No.	Size
734.022	Two Prong
734.023	Three Prong
734.024	Four Prong



Hohman's Retractors

Width mm	Length 160 mm Cat No.	Length 220 mm Cat. No.
6	735.06	735.06L
8	735.08	735.08L
10	735.10	735.10L
12	735.12	735.12L
18	-	735.18
22	-	735.22
24	-	735.24
25	-	735.25
30	-	735.30
35	-	735.35
43	-	735.43
70	-	735.70



**SELF RETAINING RETRACTOR
WITHOUT HINGES**

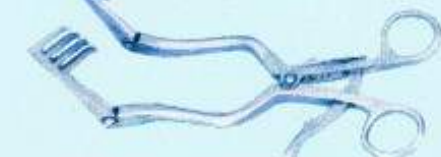

Self Retaining Retractors with Hinges

Size	Without Hinges Cat. No.	With Hinges Cat.No.
165mm	736.01	736.07
200mm	736.02	736.08
250mm	735.03	736.09
290mm	736.04	736.10
345mm	736.05	736.11
410mm	736.06	736.12

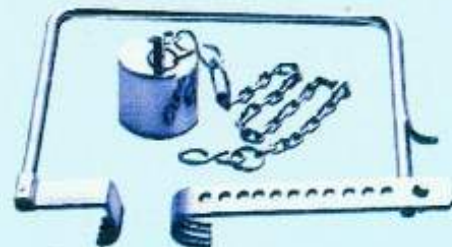

Cat. No. 736.50 Initial Incision Retractor With Weight & Chain (31)

BONE LEVERS - ELEVATORS



Cat. No. 737.01 Lane's Bone Lever Small



Lane's Bone Lever

Cat. No.	Size
737.02	Medium
737.03	Large



Cat. No. 737.04 Lane's Bone Lever -Serrated



Elevators Doyen's Right/left

Cat. No.	Size
738.L	Left
738.R	Right



Periosteal Elevators With Fibre Handle

Cat. No.	Size
739.01	Slightly Curved blade straight edge 3mm wide
739.02	Slightly Curved blade round edge 6mm wide
739.03	Slightly Curved blade straight edge 6mm wide
739.04	Curved shaft straight edge 13mm wide
739.05	Curved shaft round edge 14mm wide
739.06	Straight shaft straight edge 13mm wide
739.07	Straight shaft round edge 14mm wide
739.08	Straight shaft round edge 20mm wide



Periosteal Elevator - Straight

Cat.No.	Size	Cat.No.	Size
740.016	6mm	740.0114	14mm
740.018	8mm	740.0116	16mm
740.0110	10mm	740.0120	20mm
740.0112	12mm	740.0125	25mm



Periosteal Elevator - Curved

Cat.No.	Size	Cat.No.	Size
740.026	6mm	740.0214	14mm
740.028	8mm	740.0216	16mm
740.0210	10mm	740.0220	20mm
740.0212	12mm	740.0225	25mm



Farabeuf Rugins

Cat. No.	Size
740.03S	Straight
740.03C	Curved



Bone File S.S. With Fibre Handle

Cat. No.	Size
741.10	100mm
741.20	150mm



Cat. No. 741.30 Bone File SS with Fibre Handle Half Round Pointed



Bone Hooks

Cat. No.	Size
742.01	Large
742.02	Medium
742.03	Small



INSTRUMENTS FOR PINS & WIRES



Wire Passer

Cat. No.	Size
742.04	Small
742.05	Medium
742.06	Large



Cat. No.742.07 Wire Twister Circular Type



Cat. No.743.00 Steinman Pin Introducer with SS Chuk & Key



Steinman Pin Holder

Cat No.	Size	Dimintions (Width X Length)
744.01	Small	130mm x 180mm
744.02	Medium	130mm x 240mm
744.03	Large	130mm x 280mm
744.04	14"	130mm x 340mm
744.05	16"	130mm x 380mm
744.06	18"	130mm x 420mm
744.07	20"	130mm x 460mm



Cat. No.745.00 Charnley Compression Clamp with 2 Steinman Pins



Cat. No.749.00 K. Wire Bender



Bone Awl with Fibre Handle

Cat. No.	Size
746.01	2.5mm
746.02	3.0mm
746.03	3.5mm
746.04	4.0mm

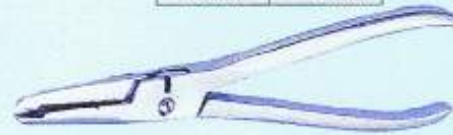

Cat. No.747.01 Wire Cutter - cum Plier -7" Cutting upto 1.5mm



Cat. No.747.02 Wire Cutter - cum Plier -9" Cutting upto 2.0mm

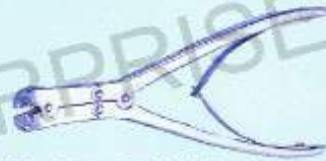

Cat. No.747.03 Wire Cutter - Double Action Cutting upto 2.5mm



Cat. No.748.00 Wire Tightner with Two Pags



Cat. No.750.00 Wire Holding Forcep

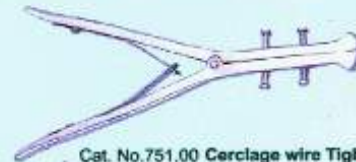

Cat. No.751.00 Cerclage wire Tightener

K. Wire Tractor

Cat. No.	Size
752.01	Small
752.02	Medium
752.03	Large





INSTRUMENTS FOR K - NAILS



Cat. No.753.01 K. Nail Extractor with Two Hooks



Cat. No.753.03 Diamond Pointed AWL



Cat. No.753.04 K. Nail Setting Device



Cat. No.753.05 K. Nail Driver



Cat. No.753.06 Measuring Gauge For K. Nail

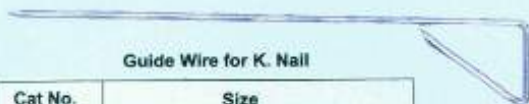

Guide Wire for K. Nail

Cat No.	Size
753.07-1	2.5 mm for 6 & 7 mm Nails
753.07-2	3.0 mm for 8 & 9 mm Nails
753.07-3	4.0 mm for 10 & 11 mm Nails
753.07-4	4.5 mm for 12 & 13 mm Nails



K. Nail Reamer

Cat.No.	Size	Cat.No.	Size
753.08-1	6mm	753.08-6	11mm
753.08-2	7mm	753.08-7	12mm
753.08-3	8mm	753.08-8	13mm
753.08-4	9mm	753.08-9	14mm
753.08-5	10mm		

INSTRUMENTS FOR SQUARE NAIL-RUSH NAIL



Cat. No.754.01 Impactor for Square Nail



Square Nail /Rush Nail Reamers

Cat. No.	Size
754.02-1	2.0mm
754.02-2	2.5mm
754.02-3	3.0mm
754.02-4	3.5mm
754.02-5	4.0mm
754.02-6	5.0mm



Extractor for Square Nail T-Handle Type

Cat. No.	Size
754.03-1	2.0mm
754.03-2	2.5mm
754.03-3	3.0mm
754.03-4	3.5mm



Square Nail Extractor Hook

Cat. No.	Size
754.04-1	2.0mm
754.04-2	2.5mm
754.04-3	3.0mm
754.04-4	3.5mm



Rush Nail Impactor /Introducer

Cat. No.	Size
754.05-1	2.0mm
754.05-2	2.5mm
754.05-3	3.0mm
754.05-4	3.5mm
754.05-5	4.0mm
754.05-6	5.0mm



INSTRUMENTS FOR HIP PROSHEIS



Cat. No. 763.01B Austin Moore Rasp Broad



Cat. No. 763.01N Austin Moore Rasp Narrow



Cat. No. 763.02 Thomson Rasp



Cat. No. 763.03 Hollow Chisel



Cat. No. 763.04A Impactor Teflon Faced Aluminium
Cat. No. 763.04S Impactor Teflon Faced S.S.



Cat. No. 763.05 Extractor with two Hooks



Cat. No. 763.07 Murphy Bone Skid



Cat. No. 763.08 Judet Extractor



Cat.No	
763.09	Measuring Gauge for Prosthesis Set of Seven 39 to 51
763.10	Measuring Gauge for Prosthesis Set of Ten 37 to 55

INSTRUMENTS FOR SPINE SURGERY

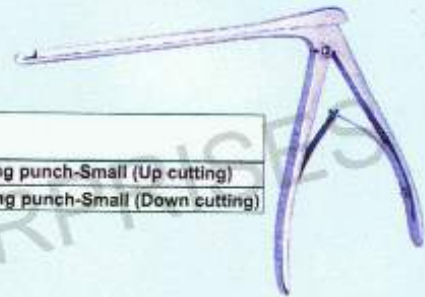

Cat.No	
777.01U	Bone cutting punch-Small (Up cutting)
777.01D	Bone cutting punch-Small (Down cutting)

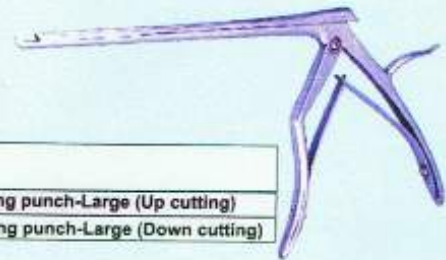

Cat.No	
777.02U	Bone cutting punch-Large (Up cutting)
777.02D	Bone cutting punch-Large (Down cutting)

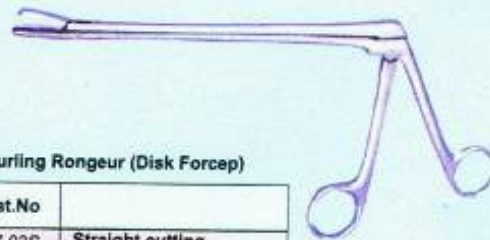

Spurling Rongeur (Disk Forcep)

Cat.No	
777.03S	Straight cutting
777.03D	Down ward cutting
777.03U	Up ward cutting



Cat. No. 777.04 Self Retaining Retractor

INSTRUMENTS FOR SPINE SURGERY



Cat. No. 777.05 Cobbs Elevator



Cat. No. 777.06 Capner Gouge



Nerve Root Retractor

Cat.No	
777.07A	Straight
777.07B	45° Angle
777.07C	90° Angle

INSTRUMENTS FOR STEFFEE IMPLANTS

Steffee Screw Tap

Cat.No	DIA
778.01	4.5mm
778.02	5.5mm

Steffee Screw Spanner

Cat.No	DIA
778.03	8mm
778.04	11mm

Steffee Screw Introducer

Cat.No	DIA
778.05	4.5mm
778.06	5.5mm



Cat. No. 778.07 Steffee Awl

INSTRUMENTS FOR SKULL SURGERY



Cat. No. 782.00 Skull Traction Apparatus

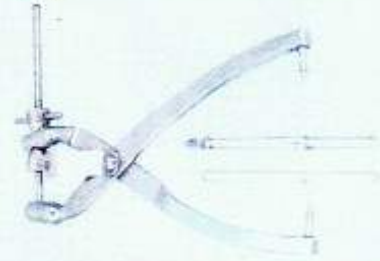

Crutch Field Tong with Two Burrs

Cat.No	Size
783.01	Small
783.02	Medium
783.03	Large



Gigle Saw Wire

Cat.No	Size
784.011	Ordinary
784.012	Fine(Imported)



Cat. No.784.02 Gigle Saw Handle (Pair)



Cat. No.784.03 Gigle Saw Introducer

Cat. No.784.04 Gigle Saw Guide

INSTRUMENTS FOR SKULL SURGERY



Cat. No. 785.00 Hudson Brace



Hudson Burrs Spherical

Cat.No.	Size	Cat.No.	Size
786.09	9mm	786.13	13mm
786.10	10mm	786.16	16mm
786.11	11mm	786.20	20mm



Hudson Drill Bits

Cat.No.	Size	Cat.No.	Size
787.09	9mm	787.13	13mm
787.10	10mm	787.16	16mm
787.11	11mm	787.20	20mm



Hudson Burr Conical

Cat.No.	Size	Cat.No.	Size
788.09	9mm	788.13	13mm
788.11	11mm	788.16	16mm

INSTRUMENTS FOR STAPLES



Cat. No. 790.01 Inserter for Coventry Staples



Cat. No. 790.02 Starter for U Staples



Cat. No. 790.03 Inserter for U Staples



Cat. No. 790.04 Extractor for U Staples



Cat. No. 790.05 Extractor for Coventry Staple



Cat. No. 790.06 Impactor for Coventry Staple

BONE DRILLING INSTRUMENTS



Cat.No.	
801.00	Electric Bone Drill with SS Chuck (Cannulation 3.5mm)
802.01	Electric Bone Drill with SS Chuck (Cannulation 3.5mm) with Reverse Operation-Delux



Cat. No. 803.00
Universal Hand Drill with SS Chuck & Key (Black Body)



Cat. No. 804.00
Universal Hand Drill with SS Chuck & Key



ONE DRILLING INSTRUMENTS



Cat. No. 805.00
Micro Hand Drill with SS Chuck & key



Cat. No. 806.00
Micro Hand Drill with SS Chuck & key Open Gear



Cat. No. 807.00
pen gear Bone Drill with SS Chuck & key



Cat. No. 810.00
Plaster Shear (Bohier's)



Cat. No. 811.00
Plaster Shear (Guy's)



Cat. No. 812.00
Plaster Saw (Bergman's)

PLASTER CUTTING INSTRUMENTS



Cat. No. 808.00
Electric Plaster Cutting Saw Oscillating Deluxe



Cat. No. 813.00
Plaster Saw (Engel)



Cat. No. 809.00
Plaster Shear (Stille's)15'



Cat. No. 814.00
Plaster Saw Heavy Handle

PLASTER CUTTING INSTRUMENTS



Cat. No. 815.00 Plaster Spreader



Cat. No. 816.00 Plaster Bender



Cat. No. 817.00 Bendage Cutting Scissor



Cat. No. 819.00 Plaster Opener - Daw's

MISCELLANEOUS INSTRUMENTS



Cat. No. 820.00 Pneumatic Tourniquet (Complete Set)



Cat. No. 822.00 Skin Grafting Handle (Small)



Cat. No. 823.00 Skin Grafting Handle (Large)



Cat. No. 823.00 Skin Grafting Handle (Large) Deluxe

Cat. No.001.00 **SCREW SET LARGE**

4.5MM CORTEX SCREWS		
7 Each of	14, 16, 18, 20, 22, 24mm	42 Pcs
14 Each of	26, 28mm	28 Pcs
12 Each of	30, 32, 34, 36, 38mm	60 Pcs
6 Each of	40, 42, 44, 46, 48, 50mm	36 Pcs
6.5MM CANCELLOUS BONE SCREWS 16MM THREAD		
2 Each of	25, 30, 35, 40, 45, 50, 55, 60mm	16 Pcs
3 Each of	65, 70, 75, 80, 85, 90, 95mm	21 Pcs
2 Each of	100, 105, 110mm	6 Pcs
6.5MM CANCELLOUS BONE SCREWS 32MM THREAD		
4 Each of	35, 40, 45, 50, 55, 60mm	24 Pcs
2 Each of	65, 70, 75, 80, 85, 90mm	12 Pcs
MALLEOLAR SCREWS 4.5MM		
2 Each of	25, 30, 35, 40, 45, 50, 55, 60mm	16 Pcs
SCALE WITH DRILL GAUGE 6"		
		1 Pc
LARGE WASHERS		
		15 Pcs
SCREW HOLDING FORCEPS		
		1 Pc
SCREW BOX WITH SS TRAY LARGE		
		1 Pc



Cat. No.01-SB
Screw box with SS tray large

Cat. No. 002.00 SCREW SET - SMALL

3.5MM CORTEX SCREWS		
4 Each of	10, 12, 20, 22, 24, 26, 28, 32, 36, 40mm	40 Pcs
8 Each of	14, 16, 18mm	24 Pcs
4.0 MM CANCELLOUS SHORT THREAD		
2 Each of	12, 14, 16, 18, 20, 22, 24, 26, 28, 30, 35, 40, 45, 50mm	28 Pcs
3.5MM CANCELLOUS		
2 Each of	12, 14, 16, 18, 20, 22, 24, 26, 28, 30, 35, 40, 45, 50, 55, 60mm	32 Pcs
SMALL WASHER		
		10Pcs
SCREW HOLDING FORCEPS		1 Pc
SCREW BOX WITH SS TRAY SMALL		1 Pc



at. No.002.SB SCREW BOX WITH SS TRAY SMALL

at. No.004.00 BASIC INSTRUMENT SET FOR DC PLATING

i49.01	Neutral and Load Drill Guide For	3.5mm Screw	1 Pc
i49.02	Neutral and Load Drill Guide for	4.5mm Screw	1 Pc
i66.25	Drill Bit S.S.	2.5mm	2 Pc
i66.32	Drill Bit S.S.	3.2mm	2 Pc
i52.01	Depth Gauge Small For	3.5mm Screw	1 Pc
i52.02	Depth Gauge Large For	4.5, 6.5mm Screw	1 Pc
i68.35	Bone Tap	3.5mm	1 Pc
i68.45	Bone Tap	4.5mm	1 Pc
i51.01	Screw Driver For	3.5mm Screw	1 Pc
i51.03	Screw Driver For	4.5mm Screw	1 Pc
i55.06	Counter Sink For	3.5, 4.5mm Screw	2 Pc
i65.10	Scale with Drill Gauge 8"	Holes in mm	1 Pc
i58.01	Plate Bender For Small Plate		1 Pair
i58.02	Plate Bender For Large Plate		1 Pair
i04.1B	Box with two SS Trays		1 Pc



Cat. No.004.1B Box with Two S.S.Tray

Cat. No.005.00

INSTRUMENTS SET FOR LARGE CANNULATED SCREWS



Cat. No.005.01

Cannulated Drill Bit 4.5mm



Cat. No.005.02

Cannulated Tap



Cat. No.005.03

Parallel Wire Guide



Cat. No.005.04

Direct Measuring Device



Cat. No.005.05

Threaded Guide Wire 1.8mm



Cat. No.005.06

Large Cannulated Hexagonal Screw Driver



Cat. No.005.07

Protection Sleeve



Cat. No.005.08 Stylet



Instrument No. 007.00

INSTRUMENTS SET FOR DHS / DCS



Cat. No. 007.01 DHS Angle Guide 135°



Cat. No. 007.02 Guide Wire 2.5mm Threaded Tip



Cat. No. 007.03 DHS Triple Reamer with Coupling End



Cat. No. 007.04 Quick Coupling T-Handle



Cat. No. 007.05 Direct Measuring Gauge



Cat. No. 007.06 Centering Sleeve For DHS Wrench



Cat. No. 007.07 Centering Sleeve For DHS Tap



Cat. No. 007.08 DHS Tap



Cat. No. 007.09 Wrench For DHS Screw



Cat. No. 007.10 DHS Impactor



Cat. No. 007.11 Coupling Screw DHS Screw Insertion

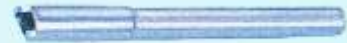

Cat. No. 007.11 A Guide Shaft for Coupling Screw



Cat. No. 007.12 Long Coupling Screw For Screw Removal



Cat. No. 007.13 DCS Triple Reamer



Cat. No. 007.14 DCS Angle Guide 95°



Cat. No. 007.1B S.S. Box with Two S.S. Trays

JULENDUR ENTERPRISES

Cat No. 008.00

ANGLED BLADE & CANDYLAR PLATE INSTRUMENTS SET



Cat. No. 008.01 Chisel Guide



Cat. No. 008.02 Seating Chisel

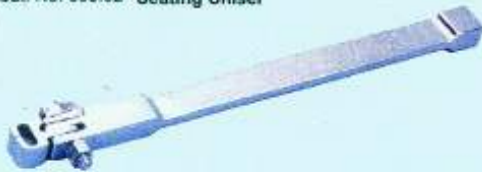

Cat. No. 008.03 Inserter - Extractor



Cat. No. 008.04 Slotted Hammer



Cat. No. 008.05 Impactor



Cat. No. 008.06 Condylar Plate Guide



Cat. No. 008.07 Triangular Positioning Plates Set



Cat. No. 008.08 Quadrangular Positioning Plates



Cat. No. 008.09 Triple Drill Guide-130° Angle



Cat. No. 008.10 S.S. Box with Two Trays

Cat No. 01.01

INSTRUMENTS SET FOR INTER-LOCKING NAILS (FEMUR)



Cat. No.755-10 Drill Guide Bar (For Femoral Nails)



Cat. No.755-08 Nail/Drill Guide Bar Holder



Cat. No.755-05 Insertion / Driving Hand



Cat. No.755-22 Combination Wrench



Cat. No.755-01 Bone AWL - Large



Cat. No.755-04 Guide Rod Length 95cm

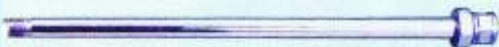

Cat. No.755-17 Ram Guide Rod



Cat. No.755-18 Ram



Cat. No.755-37 Guide Rod Holding Forcep



Cat. No.755-24 Drill Bit 3.2mm
Cat. No.755-23 Drill Bit 4.0mm



Cat. No.755-29 Depth Gauge



Cat. No.755-30 Protection Sleeve 8.0mm



Cat. No.755-32 Trocar



Cat. No.755-34 Drill Sleeve 4.0mm



Cat. No.755-27 Hexagonal Screw Driver



Cat. No.755-38 Tissue Protector



Cat. No.755-39 Container with S.S. Trays

Cat No. 010.02

INSTRUMENTS SET FOR INTER-LOOKING NAILS(TIBIA)



Cat. No.755-11 Drill Guide Bar (For Tibial Nails)



Cat. No.755-08 Nail / Drill Guide Bar Holder



Cat. No.755-05 Insertion / Driving Head



Cat. No.755-22 Combination Wrench



Cat. No.755-01 Bone AWL - Large



Cat. No.755-04 Guide Rod



Cat. No.755-17 Ram Guide Rod



Cat. No.755-18 Ram



Cat. No.755-37 Guide Rod Holding Forcep



Cat. No.755-24 Drill Bit 3.2mm

Cat. No.755-23 Drill Bit 4.0mm



Cat. No.755-29 Depth Gauge



Cat. No.755-30 Protection Sleeve 8.0mm



Cat. No.755-32 Trocar



Cat. No.755-34 Drill Sleeve 4.0mm



Cat. No.755-27 Hexagonal Screw Driver



Cat. No.755-38 Tissue Protector



Cat. No.755-39 Container with S.S. Trays

Cat No. 015.00
INSTRUMENTS SET FOR FEMORAL RECONSTRUCTION NAIL



Cat. No.755-15 Drill Guide Bar (For Recon Nails- Right)
 Cat. No.755-16 Drill Guide Bar (For Recon Nails- Left)



Cat. No.755-08 Nail / Drill Guide Bar Holder



Cat. No.755-05 Insertion / Driving Head



Cat. No.755-22 Combination Wrench



Cat. No.755-01 Bone AWL - Large



Cat. No.755-04 Guide Rod



Cat. No.755-17 Ram Guide Rod



Cat. No.755-18 Ram



Cat. No.755-37 Guide Wire Holding Forcep



Cat. No.755-26 Drill Bit(Q.C.End) - 4.8mm / 6.5mm

Cat. No.755-23 Drill Bit (Q.C. End) - 4mm



Cat. No.755-29 Depth Gauge



Cat. No.755-35 Guide Wire Sleeve



Cat. No.755-34 Drill Sleeve 4mm

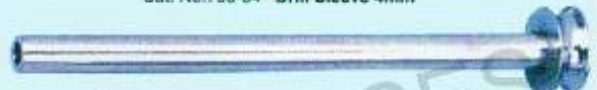

Cat. No.755-31 Protection Sleeve, Extra Long Dia. : 8mm

Cat. No.755-30 Protection Sleeve, Dia. : 8mm



Cat. No.755-33 Trocar Extra Long

Cat. No.755-32 Trocar



Cat. No.755-27 Hexagonal Screw Driver with Long Shaft



Cat. No.755-38 Tissue Protector



Cat. No.755-36 Guide Wire (For Recon Nails)



Cat. No.755-39 Container with Tray SS



Cat No. 011.00
INSTRUMENTS SET FOR INTER -LOCKING NAILS (HUMERUS)

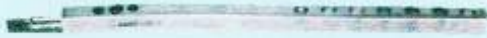

Cat. No.755-13 Drill Guide Bar (For Humerus Nails)



Cat. No.755-14 L-Shaped Drill Guide



Cat. No.755-09 Nail / Drill Guide Bar Holder



Cat. No.755-06 Insertion / Driving Head



Cat. No.755-22 Combination Wrench



Cat. No.755-02 Bone AWL - Small



Cat. No.755-19 Ram Guide Rod



Cat. No.755-20 Ram



Cat. No.755-24 Drill Bit 3.2mm

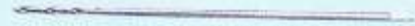

Cat. No.755-25 Drill Bit 2.3mm



Cat. No.652-01 Depth Gauge



Cat. No.755-30 Protection Sleeve



Cat. No.755-32 Trocar



Cat. No.755-34 Drill Sleeve



Cat. No.651.01 Hexagonal Screw Driver

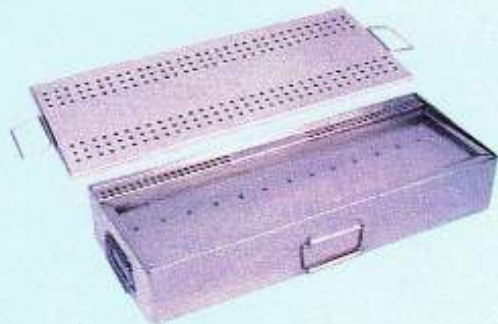

Cat. No.755-39 Container with S.S. Trays

INSTRUMENT FOR INTER -LOCKING NAILS (FREE HAND TECHNIQUE)

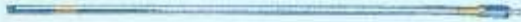

Cat. No.755-21 Flexible Reaming Shaft



Detachable Reamers

Cat. No.	Size mm
756.09	9mm
756.10	10mm
756.11	11mm
756.12	12mm
756.13	13mm

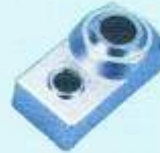

Cat. No.760-04 Direction Finder



Cat. No.760-03 Distal Aiming Device



Cannulated Straight Reamers

Cat. No.	Size mm
757.08	8mm
757.09	9mm
757.10	10mm
757.11	11mm
757.12	12mm
757.13	13mm



Cat. No.760-05 Aiming Trocar



Cat. No.760-06 Fixation Bolt



Cat. No.755-03 Reaming Rod (Guide Rod For Reamers)

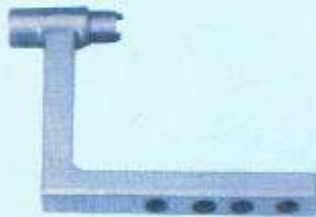

Cat. No.760-01 Insertion / Guide Handle



Sterilizing Tubes
For Sterilization of Wires, Nails, Pins & Drill Bits

Cat. No.	Size mm
012.01	150mm
012.02	250mm
012.03	300mm
012.04	400mm
012.05	500mm

THE MARK OF QUALITY & CRAFTSMANSHIP



NEURO SURGICAL INSTRUMENTS

**The House Known For
Surgical Instruments**



JULLUNDUR ENTERPRISES

Manufacturer & Exporter Of Surgical Instruments



Caspar Cervical

Vertebral Column
Retractor Frame



Scoville Retractor Frame



Medial Blades

- stainless steel



Lateral Blades

- stainless steel



Caspar Forceps

- for changing the blades



Blunt Blades



V-Blunt Blades

- stainless steel



Caspar Hand Retractor



Caspar Screw Driver for Distractor



Caspar Screw Post for Distraction

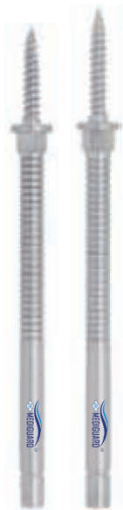

Caspar Twist Drill

Caspar Lumbar Speculum



**Counter Retractor
for Caspar Speculum**



Caspar Distractor
Punch Vertebral Retractor

• right

Caspar Distractor
Punch Vertebral Retractor

• left



Cloward Cervical Retractor

complete, with 5 toothed blades



Toothed Blades

- for Cloward Cervical Retractor



Gelpi Retractor



Caspar Cervical
Vertebral Retractor

Caspar Cervical,
Vertebral Retractor



Ribbon Retractor

- malleable



Caspar Nerve-Root Retractor



Love Nerve Retractor

- 90°
- 45°
- Straight



Love Nerve Root Retractor

Straight
45°
90°



Scoville Nerve Root Retractor



Scoville Retractor



Wide Scoville
Nerve Root Retractor



Suction Nerve Retractor

AT 2000



Spinal Compressor



Modified Lamina Spreader



Inge Lamina Spreader

- 4 x4 tip
- spring handle with speedlock

Inge Retractor

- with custom tips
- child size



Beckman-Eaton Retractor

- hinged blades
- 7 x 7 prongs
- sharp



Adson Retractor

- 4 x 4 prongs
- sharp



Beckman-Adson Retractor

- 4 x 4 prongs
- hinged
blunt
sharp

Fukushima Suction Tube



Poole Suction Tube



Andrews Pynchon Suction



Micro Suction



Frazier Suction Tube



Frazier Suction Tube

**Rhoton Micro Neuro
Suction**



Jameson Caliper



Ruler



Neuro Caliper



Caliper

straight
curved



Rosen Dissector

- angled

1.0 mm	1.4 mm	1.6 mm	2.0 mm
2.6 mm	2.8 mm	3.0 mm	



Masing Elevator

Graduated



Oschner Dissector

- double-ended
- smooth, blunt tips
- cvd



Olivecrona Dissector

- double-ended
- ligature guide



Penfield Dissector

- double-ended dissector / curette
- double-ended dissector / wax packer
- single-ended dissector
- double-ended dissector



Jansen Curette

- double-ended



Tholl Curette

- double ended

11 30 33



Micro Axial Curette

Straight

M 0400

Angled

Rev. Angled

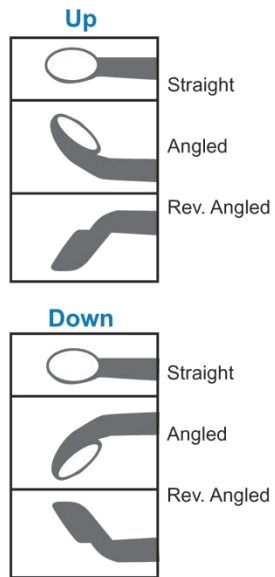

Micro Curette

Straight

M 0401

Angled

M 0402

Rev. Angled

M 0403

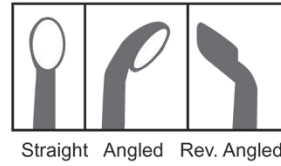

Micro Axial Curette

Straight

M 0400

Angled

Rev. Angled

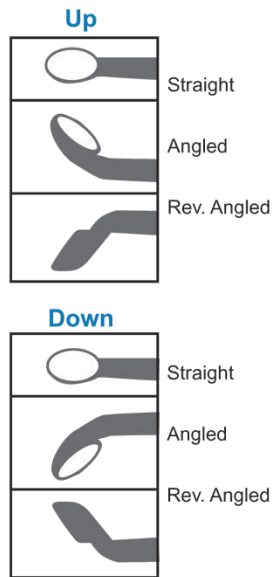

Micro Curette

Straight

M 0400

Angled

M 0400

Rev. Angled

M 0400

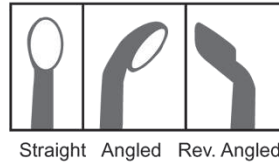

Long Handle Cone Ring Curette

- phenolic handle

straight
40° lateral



Ring Curette

- inside ring diameter



Cone Ring Curette

- Phenolic handle

Straight

31 0174

Angled

Lateral Angled

31 0175



Cobb Curette

- hollow knurled handle
- oval cup



Bruns Curette

- oval cup



Bruns Curette

- thin neck
- oval cup



**Maxillary Ostium Elevator/
Feeler**

- double-ended
- with ball tips



Cobb Spinal Elevator

- stainless

N. 0046



actual size



Wagner Elevator

- Phenolic handle

N. 0055



N. 0055

N. 0054



N. 0055

Cushing Dura Hook



Tufts Pigtail Hook

- with ball tip

spirals left
spirals right



Pashley Hooks



Murphy Ball Hook



Ball Probes



Krayenbuehl Nerve Hook

• 90°



Nerve & Vessel Hook

- stainless



Bayonet Nerve Hook



Yasargil Raspatory

- single-ended



Jacobson Raspatory

- Single-ended

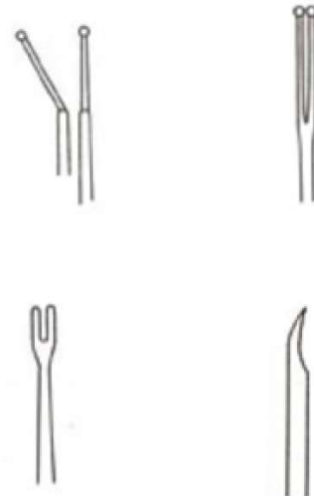

Mead Rongeur



Blumenthal Rongeur



Hartman Rongeur

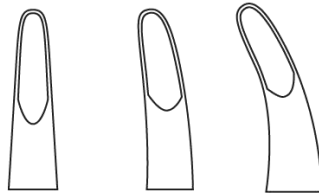

Hakansson Rongeur



Olivecrona Rongeur



Leksell Duckbill Rongeur

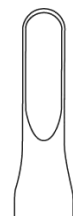
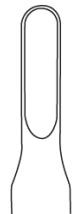
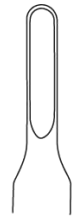
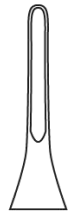

Echlin Duckbill Rongeur



Stille-Luer Echlin Duckbill Rongeur



Stille-Luer Duckbill Rongeur



Ruskin Duckbill Rongeur



Leksell Bayonet Shaped Rongeur

left
right



Stille-Luer Rongeur

- double-action



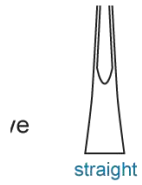

Rongeur

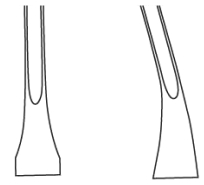

Smith-Peterson Laminectomy Rongeur



Kerrison Rongeur 8"

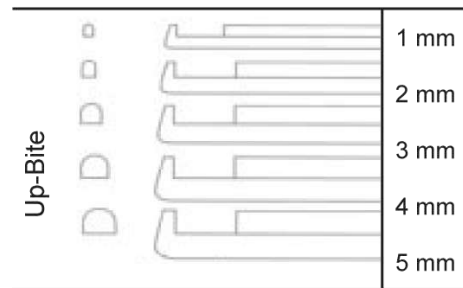
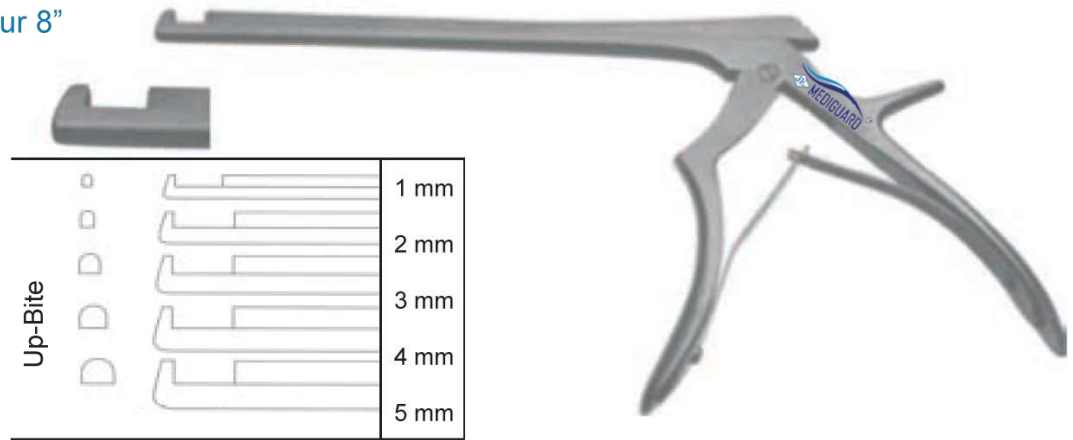

stainless steel

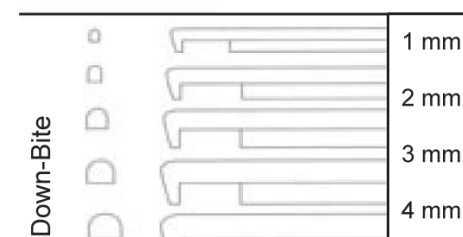
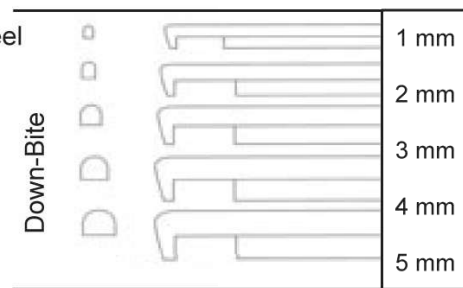

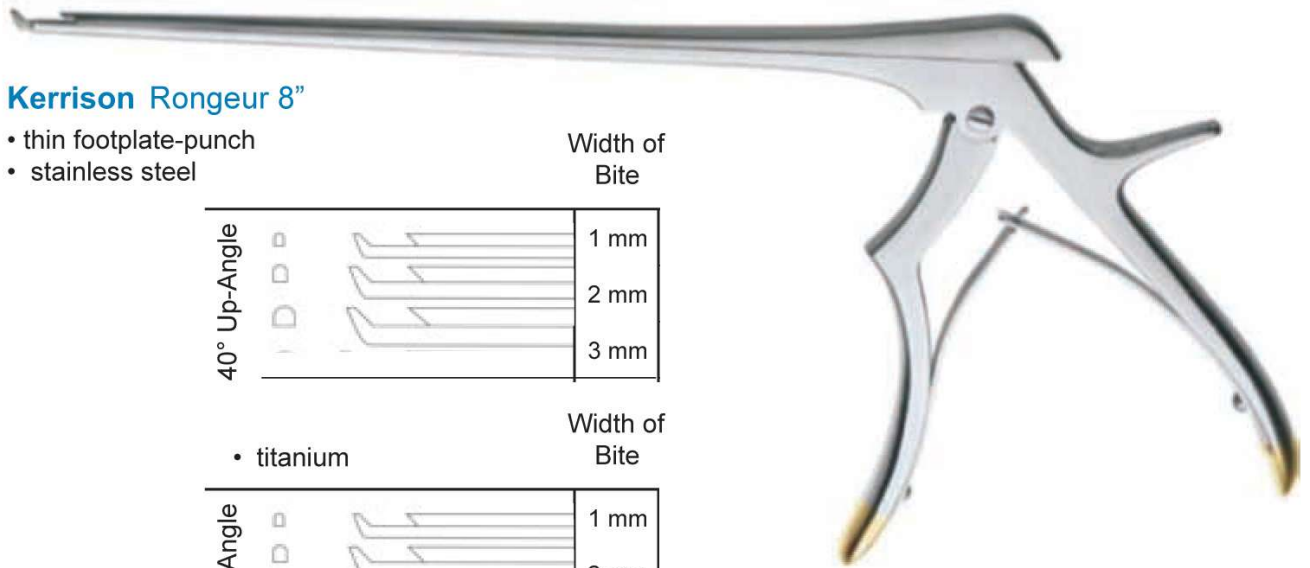







Kerrison Rongeur 8"







- thin footplate-punch
- stainless steel

Width of Bite

40° Up-Angle			1 mm
			2 mm
			3 mm

- titanium

Width of Bite

40° Up-Angle			1 mm
			2 mm
			3 mm



Cushing Pituitary Rongeur



Love-Gruenwald Pituitary Rongeur

Spurling Pituitary Rongeur

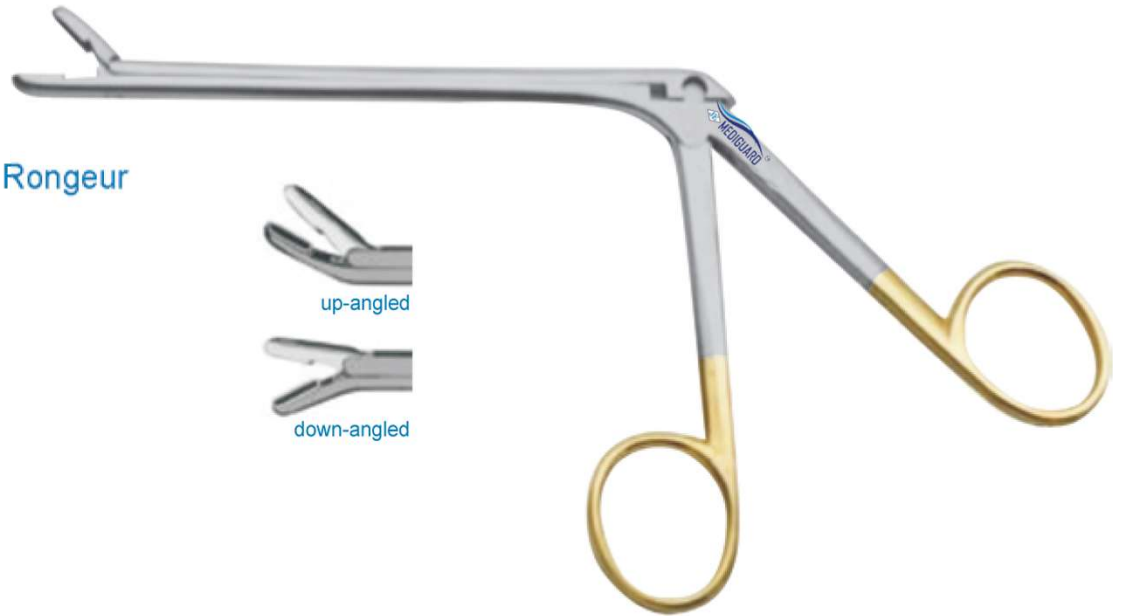

Schlesinger (Cloward) Rongeur



Caspar Grasping Rongeur

- custom instrument
- fenestrated



Micro Grasping Forceps

- 2 mm x 6 mm bite
- straight 6"



Micro Biopsy Rongeur

- round cup



- 2.0 mm cup 6"



Micro Fine Scissor

- tubular shaft
- serrated bite



- Fine Scissor 6"



Yasargil Tumor Bayonet Forcep

- 9" (23 cm)
- serrated handle

curette toothed **3 mm**
curette toothed **5 mm**



Round Handle Bayonet Forceps

- ring tip
- Straight

2 mm 8 1/4" (21 cm) (titanium)





JEWELER STRAIGHT BIPOLAR FORCEPS
4½" (11.5CM)



JEWELER CURVED BIPOLAR FORCEPS
4½" (11.5CM)



ADSON STRAIGHT WITH FINE TIP BIPOLAR FORCEPS
4¾" (12.5CM)



ADSON STRAIGHT BIPOLAR FORCEPS
6" (15CM)
8" (20CM)



Mc PHERSON BIPOLAR FORCEPS
4" (10CM)



JEWELER NO. 5 ANGLED BIPOLAR FORCEPS
4½" (11.5CM)



CUSHING COAGULATION WITH TWO PIN STRAIGHT BIPOLAR FORCEPS
6" (15CM)



CUSHING COAGULATION WITH FLAT PIN STRAIGHT BIPOLAR FORCEPS
6" (15CM)
8" (20CM)



CUSHING COAGULATION WITH IRRIGATION STRAIGHT BIPOLAR FORCEPS
6¾" (15.9CM)



HARDY BAYONET BIPOLAR FORCEPS
8½" (21.5CM)



**GERALD COAGULATION
WITH TWO PINS CURVED
BIPOLAR FORCEPS**
6" (15CM)
8" (20CM)
9" (23CM)



**GERALD COAGULATION
WITH FLAT PIN CURVED
BIPOLAR FORCEPS**
6" (15CM)
8" (20CM)



**BAYONET COAGULATION
ANGLED DOWN
BIPOLAR FORCEPS**
6" (15CM)
8" (20CM)
9" (23CM)



**SCOVILLE - GREENWOOD
BIPOLAR FORCEPS**
6" (15CM)
8" (20CM)
9" (23CM)



**POTT'S SMITH
INSULATED STRAIGHT
BIPOLAR FORCEPS**
8½" (21CM)



**POTT'S SMITH
INSULATED BAYONET
BIPOLAR FORCEPS**
6¼" (15.9CM)



**JANSEN
INSULATED BAYONET
BIPOLAR FORCEPS**
8" (20CM)



**JANSEN
INSULATED BAYONET
UPWARD CURVED TIP
BIPOLAR FORCEPS**
8" (20CM)



**DISSECTING TIP 2.0MM
BIPOLAR FORCEPS
7" (17.8CM)**



**DISSECTING TIP 2.0MM
BIPOLAR FORCEPS
8 1/4" (21CM)**



**DISSECTING
BIPOLAR FORCEPS
9 1/4" (24CM)**



**DISSECTING TIP 2.0MM
BIPOLAR FORCEPS
6 1/4" (16CM)**



**BAYONET TIP 2.0MM
BIPOLAR FORCEPS
8" (21CM)**



**BAYONET CURVED UPWARD
BIPOLAR FORCEPS
8 1/4" (21CM)**



**GERALD 1X2 TEETH
BIPOLAR FORCEPS
7" (17.8CM)**



**BAYONET TIP 1.0MM
BIPOLAR FORCEPS
7" (17.8CM)**



GERALD BAYONET COAGULATION FORCEPS WITH TWO PIN STRAIGHT BIPOLAR FORCEPS
 6" (15CM)
 8" (20CM)
 9" (23CM)



GERALD BAYONET COAGULATION FORCEPS WITH FLAT PIN STRAIGHT BIPOLAR FORCEPS
 6" (15CM)
 8" (20CM)
 9" (23CM)



GERALD BAYONET COAGULATION FORCEPS WITH SUCTION STRAIGHT BIPOLAR FORCEPS
 6" (15CM)
 8" (20CM)



GERALD BAYONET COAGULATION FORCEPS WITH IRRIGATION STRAIGHT BIPOLAR FORCEPS
 6" (15CM)
 8" (20CM)



BAYONET COAGULATION WITH FLAT PIN CURVED BIPOLAR FORCEPS
 6" (15CM)
 8" (20CM)
 9" (23CM)



BAYONET COAGULATION WITH SUCTION CURVED BIPOLAR FORCEPS
 6" (15CM)
 8" (20CM)



BAYONET COAGULATION WITH TWO PINS CURVED BIPOLAR FORCEPS
 6" (15CM)
 8" (20CM)



BAYONET COAGULATION WITH IRRIGATION CURVED BIPOLAR FORCEPS
 6" (15CM)
 8" (20CM)

ABBEY SUB MUCOSAL RESECTION



**MONOPOLAR
SUCTION TUBE**
5FR
8FR
10FR



**ANTRUM MONOPOLAR
SUCTION TUBE**



**SUCTION TUBE
BIPOLAR**



**NEEDLE
BIPOLAR**



**KNIFE
BIPOLAR**



**BIPOLAR SURGICAL
PATIENT PLATE**
7507



**BIPOLAR FOOT
PADDLE**
7509



CABLE



BIPOLAR SURGICAL HANDLE



BIPOLAR CABLE TWO PIN



BIPOLAR CABLE ROUND PIN



BIPOLAR CABLE FLAT PIN



BIPOLAR CABLE TWO PIN





**METZENBAUM SCISSORS
CURVED
STAINLESS STEEL**

**METZENBAUM SCISSORS
STRAIGHT
STAINLESS STEEL**





METZENBAUM SCISSORS
CURVED
STAINLESS STEEL

METZENBAUM SCISSORS
STRAIGHT
STAINLESS STEEL



**GREEN BERG
SCISSORS (KILNER)
CURVED
STAINLESS STEEL**

**GREEN BERG SCISSORS
(KILNER)
STRAIGHT
STAINLESS STEEL**



**MAYO SCISSORS
CURVED
STAINLESS STEEL**

**MAYO SCISSORS
STRAIGHT
STAINLESS STEEL**



**STEVENS SCISSORS
CURVED
STAINLESS STEEL**

**STEVENS SCISSORS
STRAIGHT
STAINLESS STEEL**



**IRIS SCISSORS
STRAIGHT
STAINLESS STEEL**



**IRIS SCISSORS
CURVED
STAINLESS STEEL**



ADSON FORCEPS
PLAIN
STAINLESS STEEL
5"



**MICRO SPRING
NEEDLE HOLDER**
ROUND WITH LOCK
CURVED
STAINLESS STEEL
6"



ADSON FORCEPS
1x2 TOOTH
STAINLESS STEEL
5"



**MICRO SPRING
NEEDLE HOLDER**
ROUND WITHOUT LOCK
STRAIGHT
STAINLESS STEEL
6"



**MICRO SPRING
NEEDLE HOLDER**
ROUND WITHOUT
LOCK CURVED
STAINLESS STEEL
6"



**MICRO SPRING
NEEDLE HOLDERS FLAT
WITHOUT LOCK STRAIGHT
STAINLESS STEEL**



**MICRO SPRING
NEEDLE HOLDERS FLAT
WITH OUT LOCK CURVED
STAINLESS STEEL**



**MICRO SPRING
NEEDLE HOLDERS FLAT
WITH LOCK STRAIGHT
STAINLESS STEEL**



**MICRO SPRING
NEEDLE HOLDERS FLAT
WITH LOCK CURVED
STAINLESS STEEL**



MICRO NEEDLE HOLDER
BAYONET TYPE
STRAIGHT
STAINLESS STEEL



MICRO NEEDLE HOLDER
BAYONET TYPE CURVED
STAINLESS STEEL





MICRO SPRING SCISSORS
FLAT CURVED
STAINLESS STEEL

MICRO SPRING SCISSORS
FLAT STRAIGHT
STAINLESS STEEL



MICRO SPRING SCISSORS
ROUND CURVED
STAINLESS STEEL

MICRO SPRING SCISSORS
ROUND STRAIGHT
STAINLESS STEEL

Cob Type Spinal Gouges



Bayonet Spinal Knife



Leyla Retractor

full set
single strand

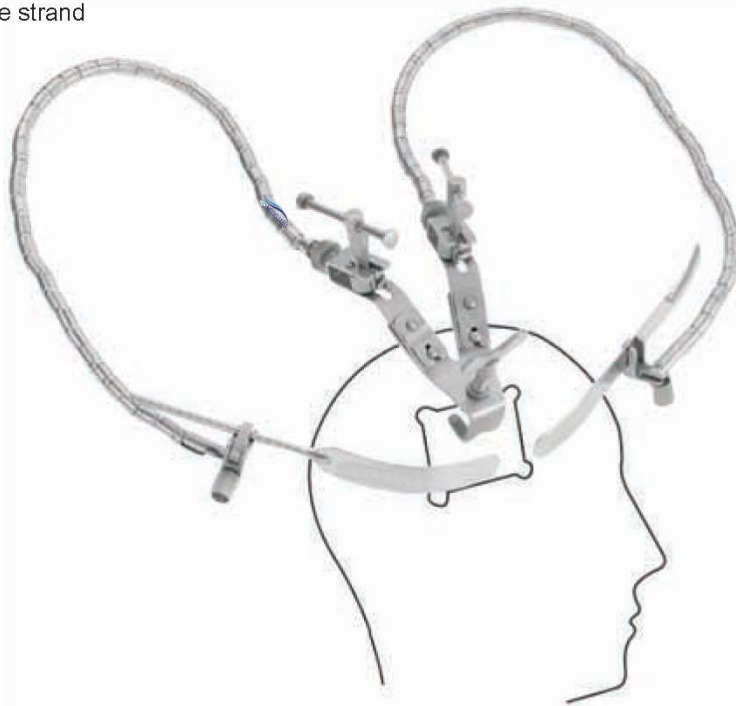

Microvascular Clamps

- for ordering, use order numbers listed below
- also available in black

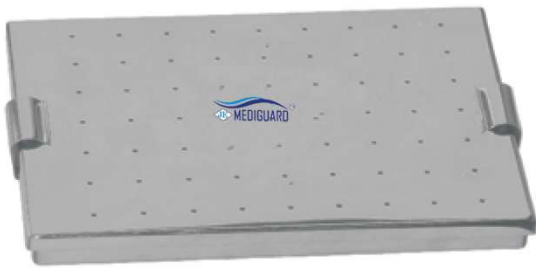

**INSTRUMENTS STERILIZING
PERFORATOR BOX
STAINLESS STEEL**



**AUTOClave INSTRUMENT BOX
WITH SILICONE MATT
STAINLESS STEEL**



CIDEX BOX HEAVY
STAINLESS STEEL



SURGICAL TRAY WITH LID
HEAVY STAINLESS STEEL

Tray for Micro Instruments

silicone mat

Slim Thermo Plastic Instrument Tray



Cob Type Spinal Gouges

straight
medium curve



Bayonet Spinal Knife



Microvascular Clamps

- for ordering, use order numbers listed below
- also available in black

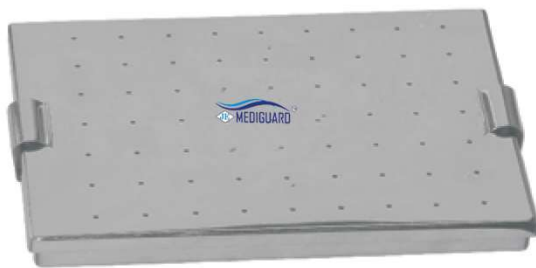

**INSTRUMENTS STERILIZING
PERFORATOR BOX
STAINLESS STEEL**



**AUTOClave INSTRUMENT BOX
WITH SILICONE MATT
STAINLESS STEEL**



CIDEX BOX HEAVY
STAINLESS STEEL
28" x 6" x 5"



SURGICAL TRAY WITH LID
HEAVY STAINLESS STEEL

Tray for Micro Instruments

silicone mat

Slim Thermo Plastic Instrument Tray



THE MARK OF QUALITY & CRAFTSMANSHIP



PLASTIC SURGICAL INSTRUMENTS

**The House Known For
Surgical Instruments**



JULLUNDUR ENTERPRISES

Manufacturer & Exporter Of Surgical Instruments





B.P. Handle No. 3



B.P. Handle No. 4



B.P. Handle No. 7



B.P. Handle Round



B.P. Handle Curved



B.P. Handle Baynet

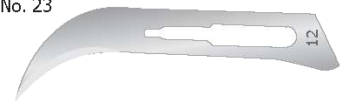

B.P. Blade No. 10
 B.P. Blade No. 11
 B.P. Blade No. 12
 B.P. Blade No. 15
 B.P. Blade No. 21
 B.P. Blade No. 23



MAYO SCISSORS
STRAIGHT
STAINLESS STEEL



MAYO SCISSORS
CURVED
STAINLESS STEEL



MAYO SCISSORS
STRAIGHT
TUNGSTEN CARBIDE



MAYO SCISSORS
CURVED
TUNGSTEN CARBIDE



MAYO SCISSORS
STRAIGHT
SUPER CUT



MAYO SCISSORS
CURVED
SUPER CUT

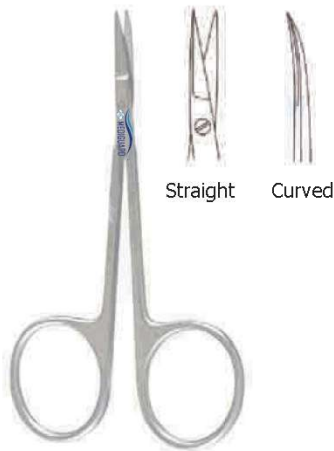

Straight Curved

IRIS SCISSORS
Straight

S.S.

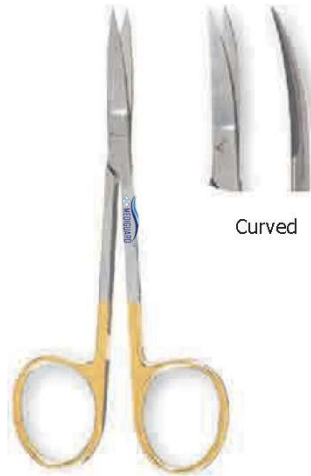

Curved

IRIS SCISSORS

T.C.
Straight
Curved

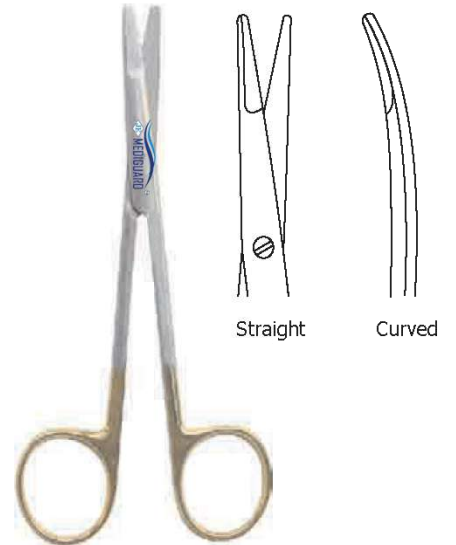

Straight Curved

GREEN BERG SCISSORS (KILNER)

T.C.
Straight
Curved
Super Cut
Straight
Curved



KNAPP SCISSORS

S.S.
Straight
Curved
T.C.
Straight
Curved
Super Cut
Straight
Curved



Pott's Angle Scissors

25°
45°
60°



O' Brien Stitch Removal
4 1/2"



STEVENS SCISSORS

S.S.
Straight
Curved
T.C.
Straight
Curved
Super Cut
Straight
Curved



Straight



Curved

MAYO SCISSORS

S.S.
Straight
Curved
T.C.
Straight
Curved
Supercut
Straight
Curved

6"

8"

10"

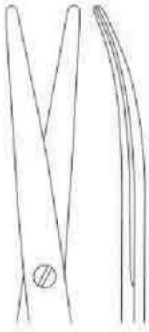

Straight Curved

METZENBAUM SCISSORS

S.S.
Straight
Curved
T.C.
Straight
Curved
Supercut
Straight
Curved

6"

8"

10"



Fomon Angular Scissors



Heymann Scissors



Hartman Packing Forceps



Tilley Packing Forceps



S.S. 7065
T.C.-17098

GILLIES NEEDLE HOLDER WITH SCISSORS

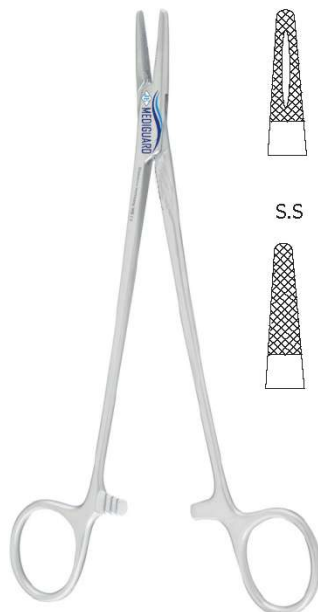

S.S

MAYO HEGAR NEEDLE HOLDER



S.S



S.S

NEEDLE HOLDER RYDER T.C.



CRILE WOOD DEBAKEY NEEDLE HOLDER T.C.



MATHIEU NEEDLE HOLDER T.C.



NEEDLE HOLDER FINE T.C.



Bozemann Needle Holder

S.S.

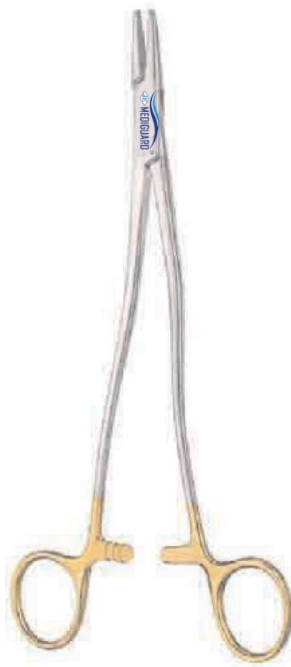

Killner Needle Holder Fine T.C.

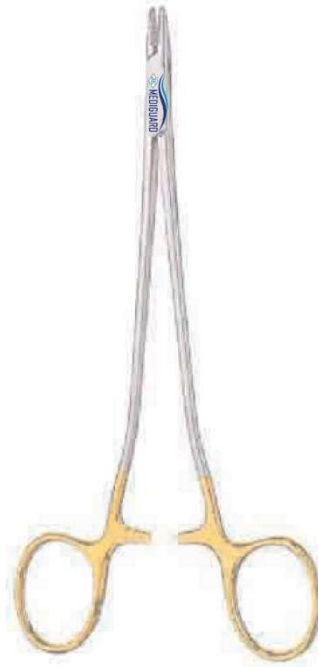

Senning Needle Holder T.C.



Allis Tissue Forceps



Wire Holding Forceps



Mosquito Forceps



Artery Forceps



Kochers Forceps



Adson Forceps Plain



Adson Forceps Tooth



Fine Adson Forceps



SS



SS
Tooth



Dissecting Forceps



Tooth



Tooth



Debaquey Forceps



Nelson Tissue Forceps



Jansen Baynot
Packing Forceps



Tooth





Angled



Angled



Tooth



Tooth



Tooth

Micro Forceps Round

Micro Forceps Round Tooth

Micro Forceps Tooth S.S.
Micro Forceps Tooth S.S.

Plain Micro Forceps with Platform 6" SS
Plain Micro Forceps with Platform 6" SS

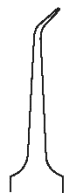

Tooth



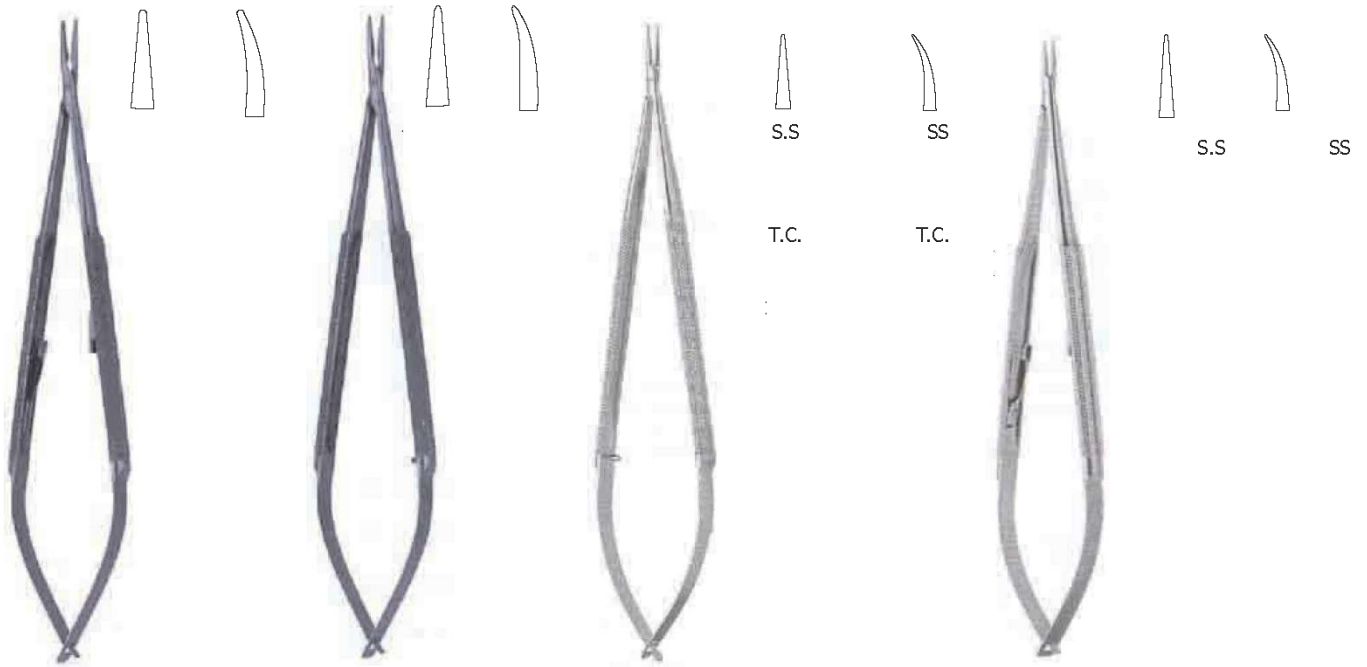

Micro Needle Holder Round with Lock

Micro Needle Holder Round

Micro Needle Holder Flat

Micro Needle Holder Flat with lock



Debakey Bull-Dog Clamps

Debakey Bull-Dog Clamps Curved

Micro Apply Clamps Single

Micro Apply Clamps Double

Mosquito Forceps Atraumatic Serration



Measuring Clamp



Caliper



Caliper Curved

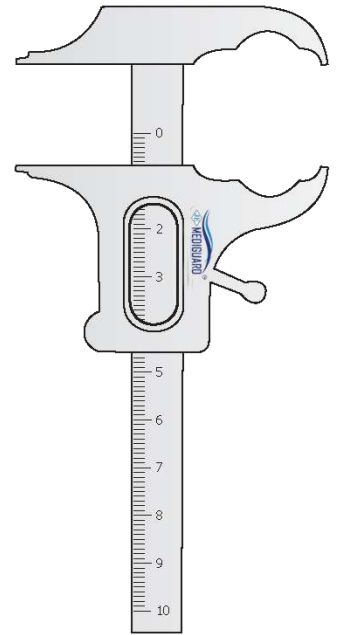

Measuring Scale



Nose Tip Marker



Large

Killian Nasal Speculum Medium



Killian Nasal Speculum with Fiber Optic Light



Cottle Retractor Blunt



Cottle Retractor Sharp



Kilner Alar Retractor



Cottle Uper lateral Retractor



Joseph Retractor Fine Sharp



Kilner Retractor



Gillies Skin Hook



Rollet extractor Spring Action

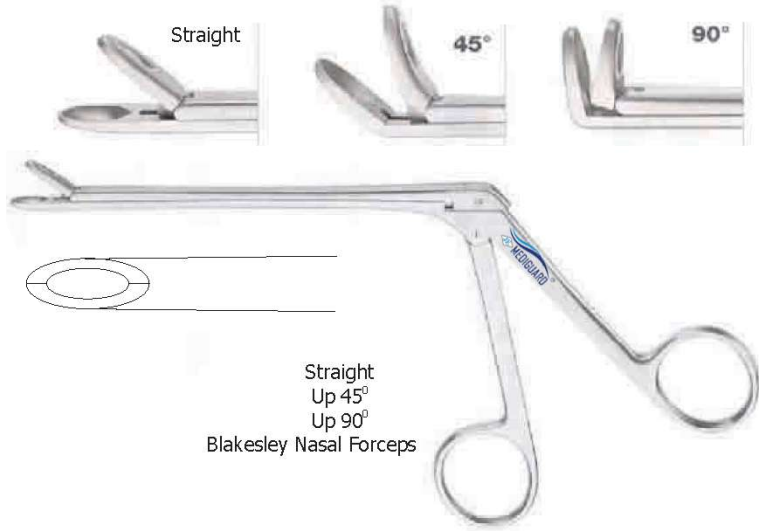

Freer Knife

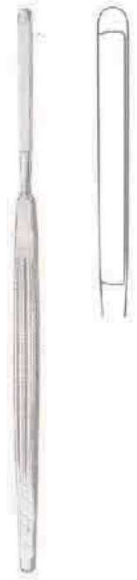

Joseph Knife Straight



Joseph Knife Curved



Masing Elevator with Graduated



Cottle Mckenty Elevator



Cohen Elevator



Pennington Elevator



Freer Elevator



Nagata Elevator



Joseph Nasal Elevator



Cottle Elevator



Walter Elevator



Peristal Elevator

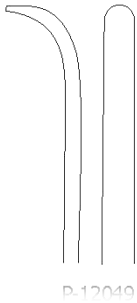

P-12040



Suction with Dissector



Mallet



Columella Nasal Clamp



Chalazion Clamp

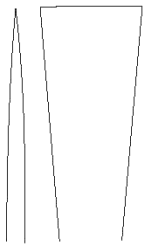

Gillies Chisel

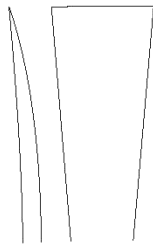

Gillies Osteotome



Measuring Chisel



Osteotome Moon Type



6mm

Cinelli Nasal Osteotome



Jenkins Gouge



Killian Nasal Gouge



Tilley Septum Gouge V shape



Left



Right

Silver Chisel Straight



Malinac Nasal Retractor



Aufricht Retractor Nasal with Handle



Joseph Nasal Saw



Right

left



Fomon Double Ended Rasp



Aufricht Rasp

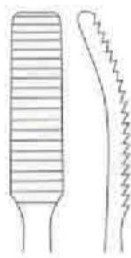

Maltz Rasp

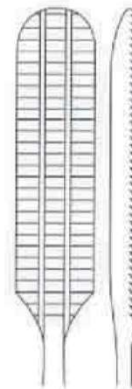

Aufright Nasal Rasp

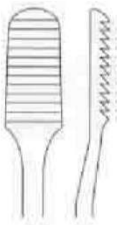

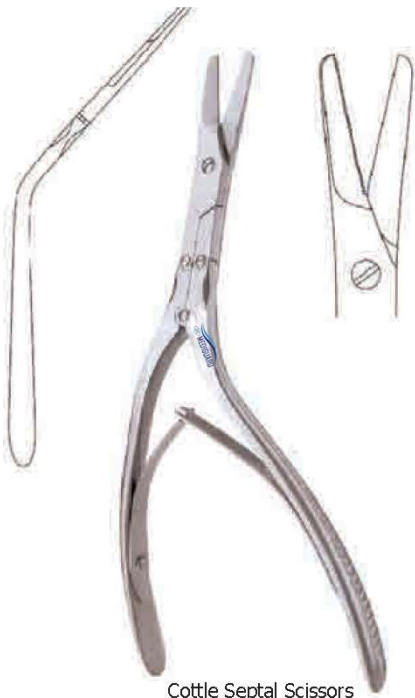

Cottle Septal Scissors
Double Action

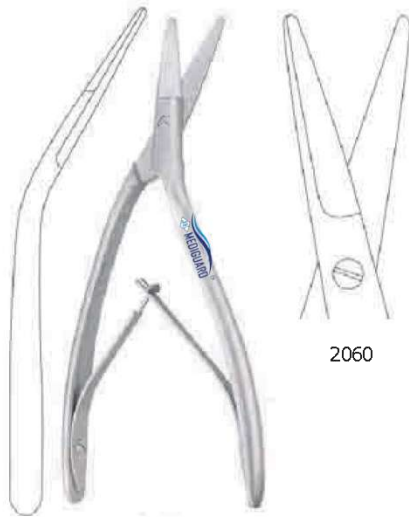

Cottle Septal Scissors

2060



Bone Cutter



Septum Morcelizer



Walsham Septum Forceps

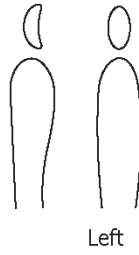

Left



Walsham Septum Forceps

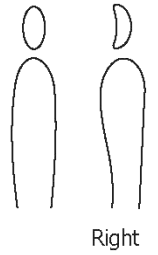

Right



Walsham Septum Straight Forceps



Ash Septum Forceps



Catlage Cruiser



Tourniquet with Pump Along with 3 Cup



Micro Bone Drill

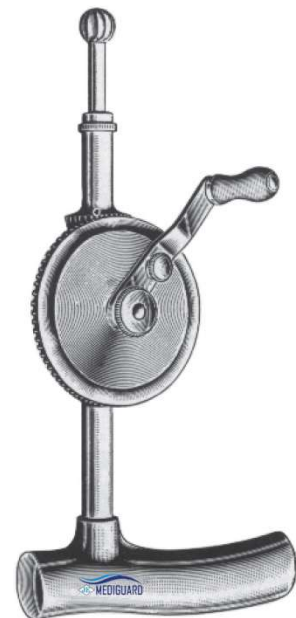

Universal Hand Drill



Heavy Duty Micro Motors



Derma Brazier Burrs Diamond



Plate Bender



Screw Driver with Adjustable



Screw Driver Plain



K Wire Introducer



Plate Bender



Plate Holding



Bone Holding Forceps



Tendon Holding Forceps

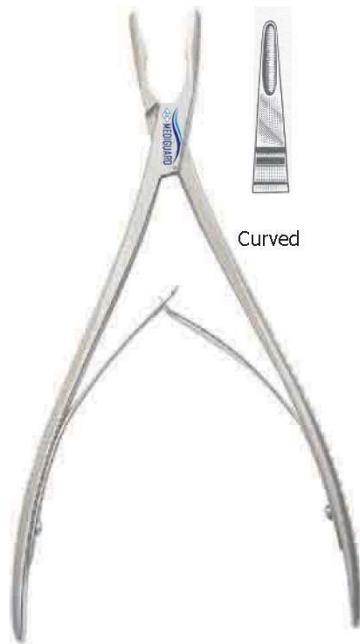

Lempert Rongeur St.

Curved



Stille Ruskin Bne Rongeur
Curved



Stille Ruskin Bne Rongeur
Straight



Wire Cutter



Weire Cutter
Cutting 2.0mm Wire



Top Cutter
Cutting 2.0mm Wire

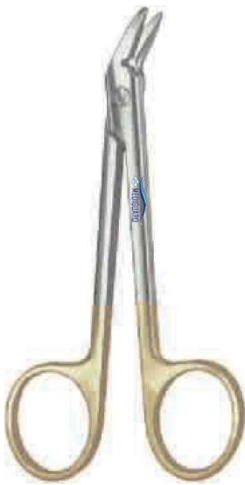

Wire Cutting Scissors

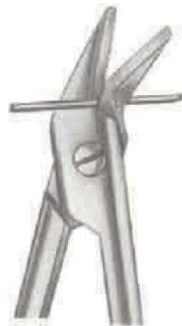

Weire Cutter
Cutting 2.0mm Wire



Dingman Mouth Gag
with 3 Tongue Plates



Doyan Mouth Gag
Adult
Child



Heister Mouth Gag



Mouth Gag

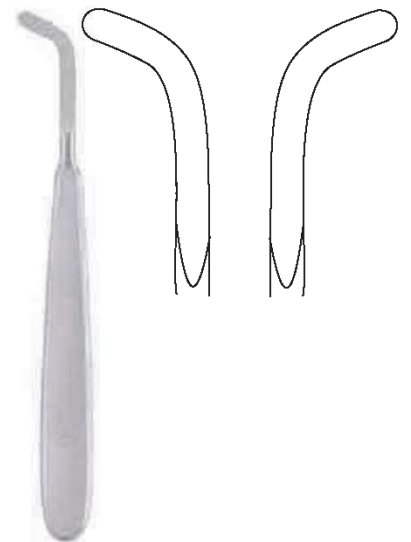

Rose Raspatory

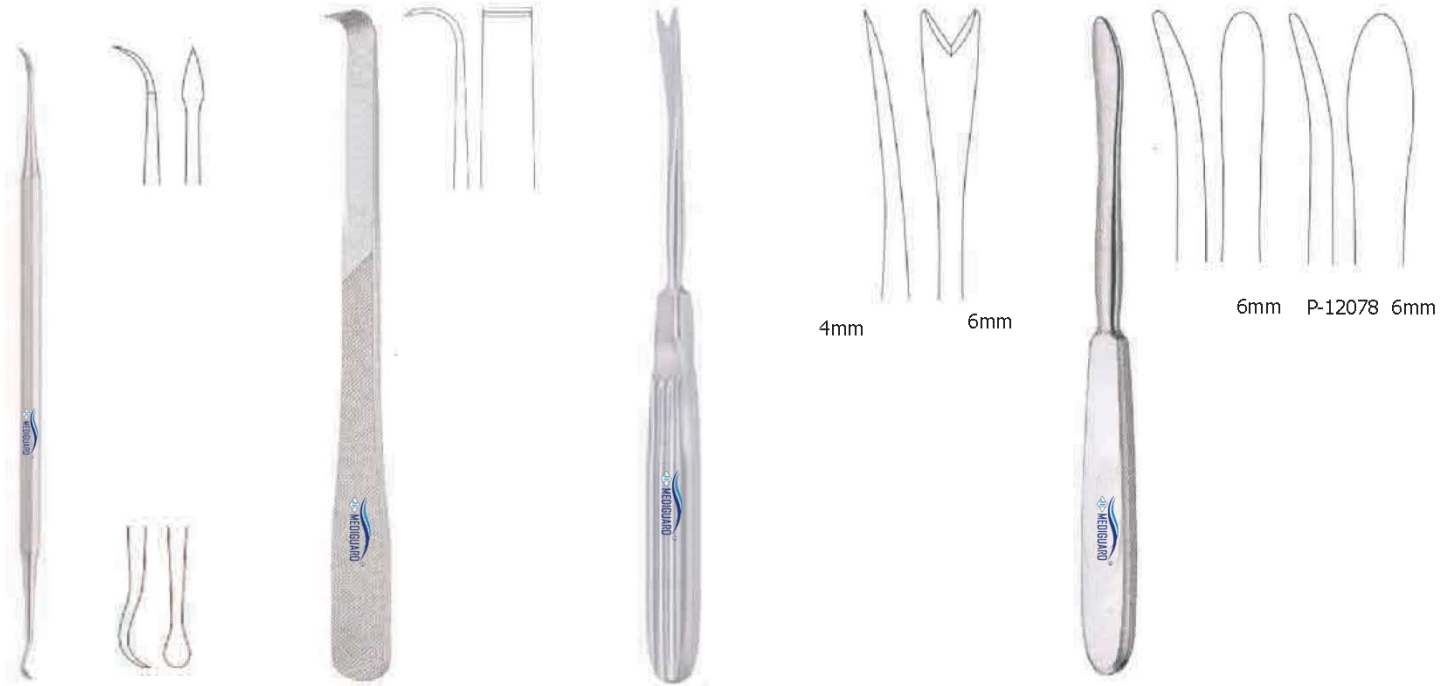

Mc. Indoe Elevator

Maxilla Mobilizer Elevator

Obwegeser Raspatorien

Langenbeck Elevator



Plester Self Retaining Retractor
Solid Blade



Plester Self Retaining Retractor
2x2 prongs



Gelpi Retractor



Rowe Zygomatoc Elevator



Bristow Malar Elevator



Hayton Willams Forceps



Hayton Williams Forceps



Rowe Disimpaction Forceps Left



Rowe Disimpaction Forceps Right



Bone Awl



Bone Awl



Bone Awl Large

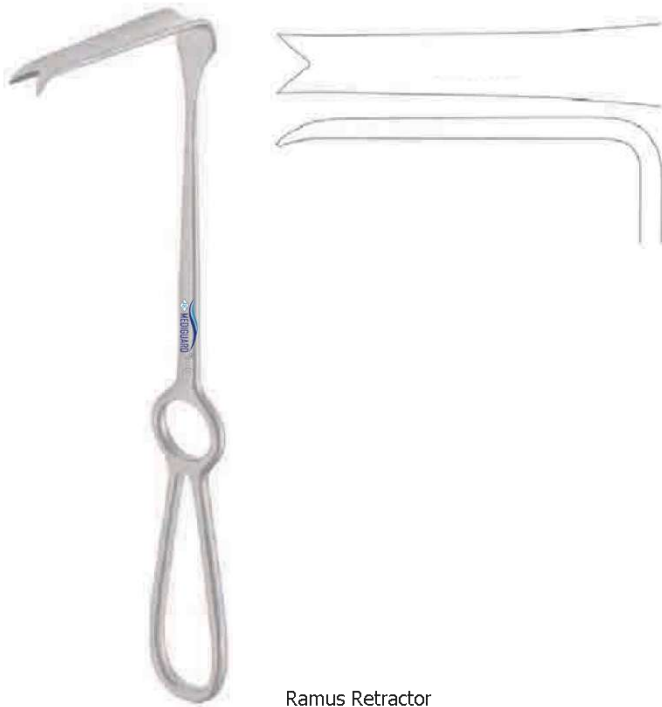

Ramus Retractor

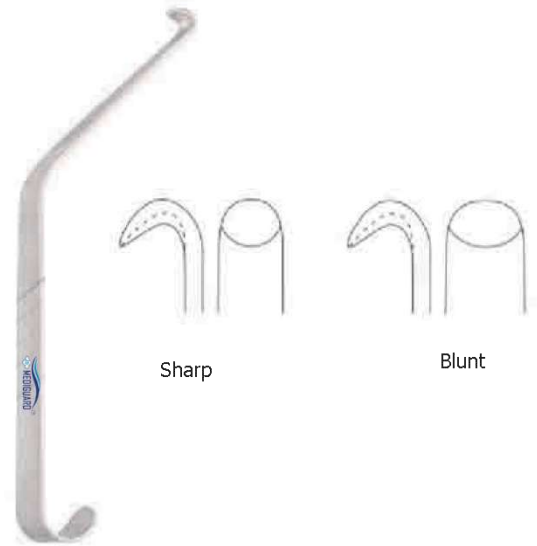

Sharp

Blunt

Channel Retractor



Chin Retractor



Muco Periost Retractor



Muco Periost Retractor



Arch Bar



Lane's Retractor



Soft Tissue Retractor



Skin Biopsy Punch



Skin Biopsy Punch Forceps Fine



Hair Transparent Punch & Introducer



Hair Transparent Punch



Disposable Skin Punch



Skin Punch



Skin Stainless Steel Punch



Silver Skin Grafting Knife
for Saving Blades



Humby Skin Grafting Handle



Watson Skin Grafting Handle



Skin Grafting Knife Blade



Heaney/Simon
(Retractor) Fiber optic Light



Lighted Freeman Flap Retractor
with Fiber optic Light



Deavers Retractors with Fiber Optic Light



Aufrecht Nasal Retractor
with Fiber Optic Carrier



Ribbon (Carins Strip Retractors)
Malleable Retractors



Soft Tissue
Retractor

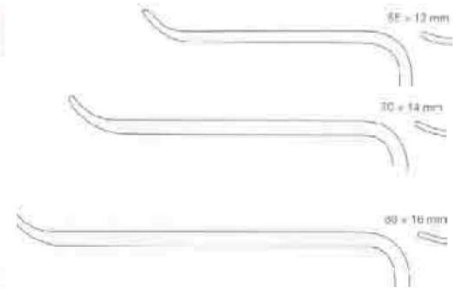



Fiber Optic Cable



Fiber Optic Head Light Band



Fiber Optic Light Source
Double Point



Biggs Mammoplasty Retractor
with Suction
& Fiber Light Carrier

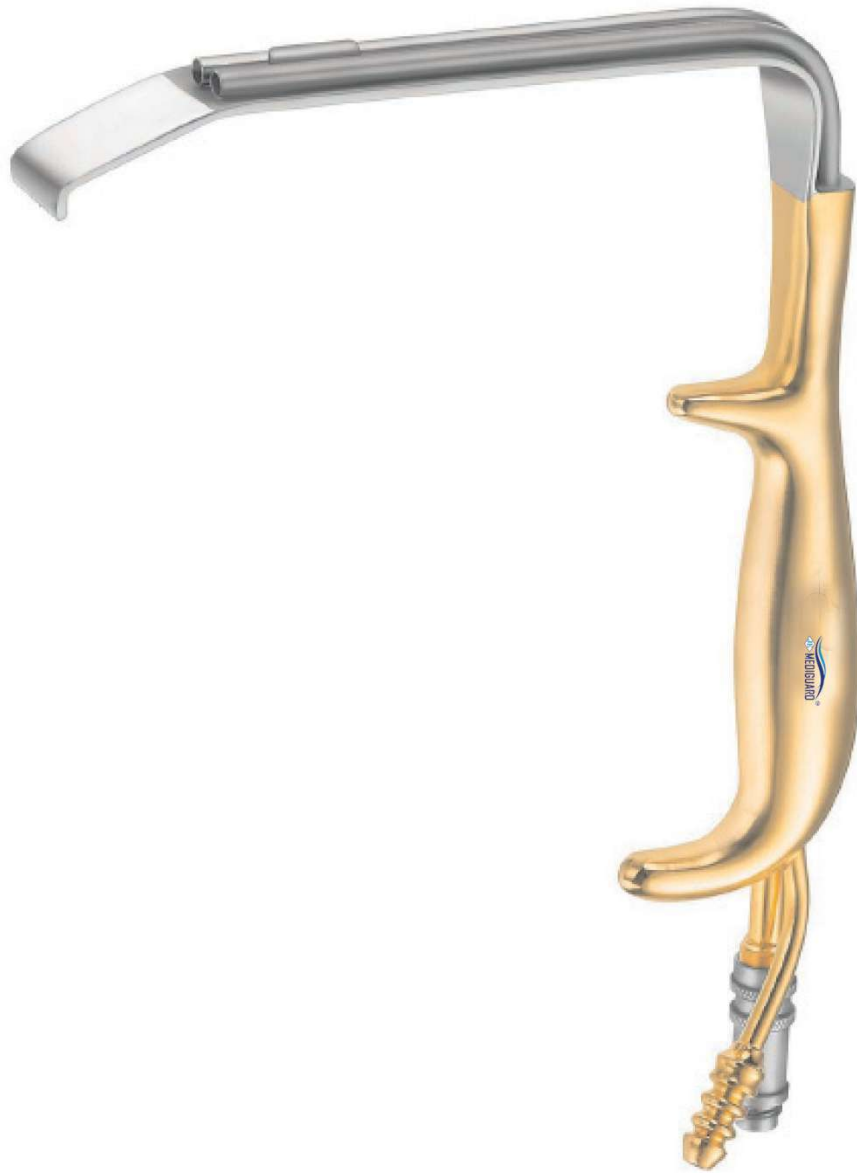

Tannetts Retractor
with Fiber Optic Illumination
& Irrigation Tube



Fiber Optic

Tebbetts Retractor with
Fiber Optic Illumination & Irrigation Tube



Tebbetts Style
(with tooth serrated end)



Ferreira Style
(with smooth end)



Marx Breast Retractor



Solz Breast Retractor



Solz Breast Retractor



Agris-Dingman Transaxillary Breast Dissector Pair: Left/Right



Mac Collum-Dingman Transaxillary Breast Dissector Angled Shaft



Autoclave Instruments Box with Silicon Matt



Freeman Rake



P-12134 1.5in



Yancoskie Abdominoplasty Retractor



- 3mm
- 4mm
- 5mm
- 6mm
- 8mm
- 10mm

Liposuction Cannula with adpoter length 11 Inch Curved



- 3mm
- 4mm
- 5mm
- 6mm
- 8mm
- 10mm

Liposuction Cannula with adopter length 11inch

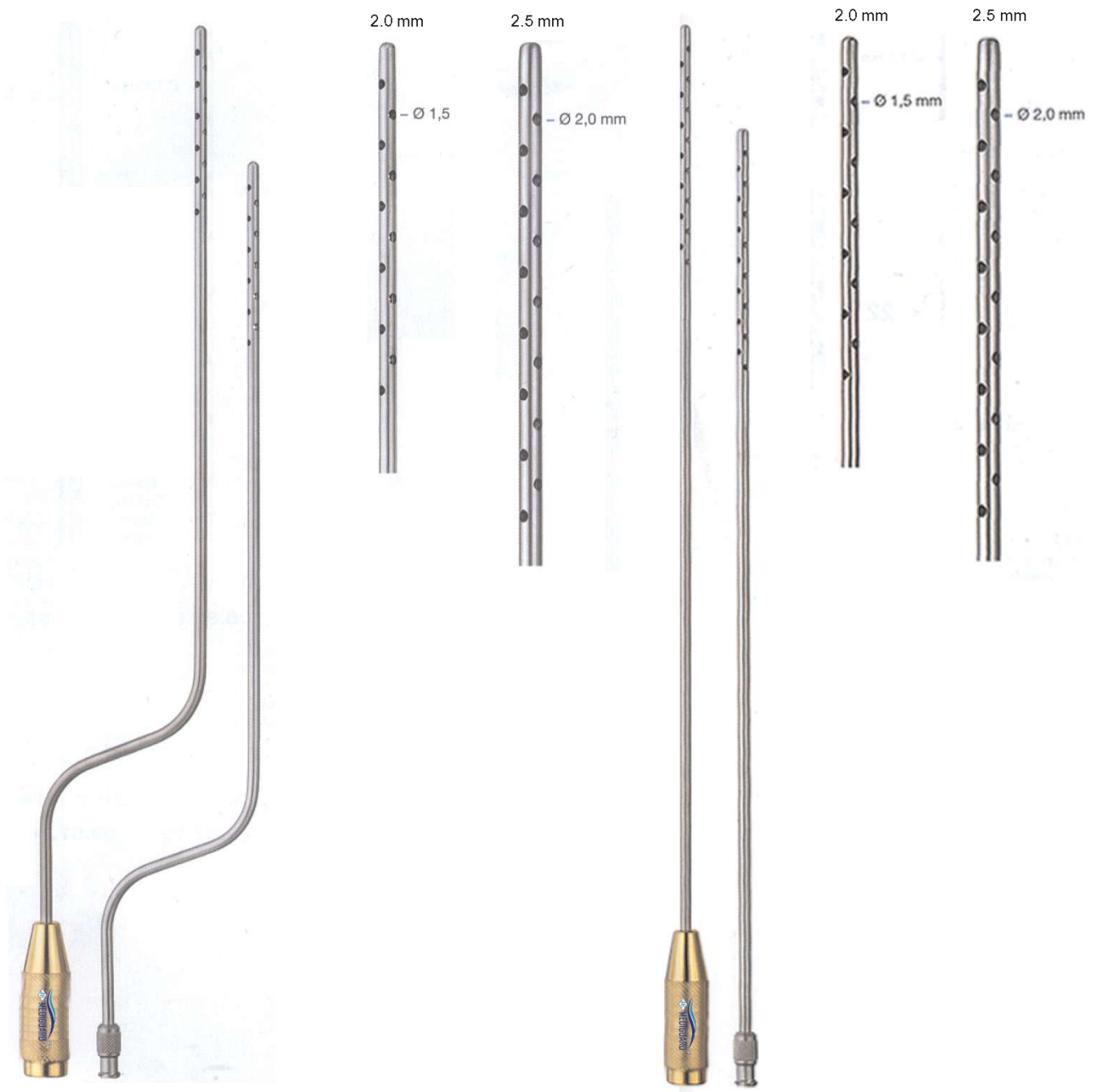

Cannulas and Syringes for Infiltration Length 11 inch

- P-12151 2mm
- P-12152 2 1/2mm

Cannulas and Syringes for Infiltration Length 11 inch

- P-12153 2mm
- P-12154 2 1/2mm

THE MARK OF QUALITY & CRAFTSMANSHIP



OPHTHALMIC SURGICAL INSTRUMENTS

**The House Known For
Surgical Instruments**



JULLUNDUR ENTERPRISES

Manufacturer & Exporter Of Surgical Instruments





MOORFIELDS
CONJUNCTIVAL FORCEPS
STRAIGHT

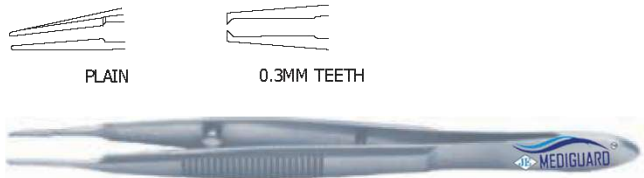

RYCROFT CORNEAL
TYING FORCEPS STRAIGHT



Mc PHERSON
TYING FORCEPS
STRAIGHT 7MM PLATFORM

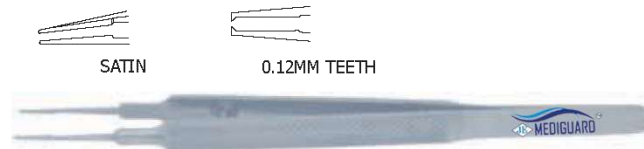

BIRKS TYING
FORCEPS STRAIGHT



SLIMLINE
FORCEPS STRAIGHT
PLAIN
TYING



SLIMLINE
FORCEPS STRAIGHT
0.1MM TEETH
FORWARD FACING
0.12MM TEETH



CASTROVIEJO TYING
FORCEPS STRAIGHT
DELICATE
0.25MM NOTCH



CASTROVIEJO TOOTH
FORCEPS STRAIGHT
0.3MM TEETH
0.5MM TEETH
0.12MM TEETH



Mc PHERSON
TYING FORCEPS
7MM ANGLED JAWS
LONG HANDLE



GUTIERREZ-C
COMBI MICRO FORCEPS
SCISSORS
CAPSULORHEXIS

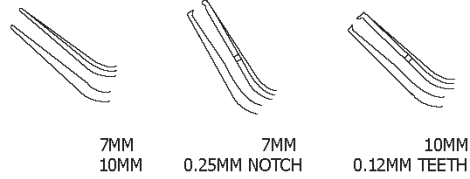

BIRKS
TYING FORCEPS
ANGLED JAWS



Mc PHERSON
TYING FORCEPS
ANGLED JAWS SHORT HANDLE
10MM



UTRATA
CAPSULORHEXIS FORCEPS
STANDARD SHANK
SHARP TIP
DELICATE TIP

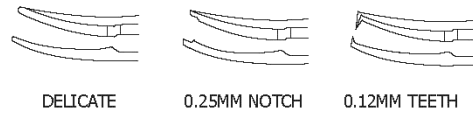

TYING FORCEPS
CURVED JAWS



CASTROVIEJO COLIBRI
TYING FORCEPS
0.12MM TEETH



SLIMLINE
COLIBRI FORCEPS
TYING
0.25MM NOTCH
0.1MM TEETH
FORWARD FACING



CAPSULORHEXIS
FORCEPS SLIMLINE
STANDARD SHANK
SERRATED STANDARD TIP
SERRATED SHARP TIPS



CAPSULORHEXIS
FORCEPS WIDE BODY
STANDARD SHANK
DELICATE TIPS



CLAYMAN INTRAOCULAR
LENS INTRODUCING
FORCEPS
RIGHT HAND
LEFT HAND



LIM'S PIERSE
TYPE FORCEPS
NO. 18 0.5MM TIP



TROUTMAN SUPERIOR
RECTUS FORCEPS
MUSCLE



BIRKS
TYING FORCEPS
CURVED JAWS



GRAEFE IRIS
FORCEPS
SERRATED TIPS 1MM
CURVED



GRAEFE IRIS
FORCEPS
SERRATED TIPS 1MM
STRAIGHT



ROUND END
CILIA FORCEPS



WHITFIELD
CILIA FORCEPS



SPRING ACTION
CILIA FORCEPS



JAMESON STRABISMUS
MUSCLE FORCEPS
7X2X0.6MM DEEP
ADULT RIGHT
ADULT LEFT

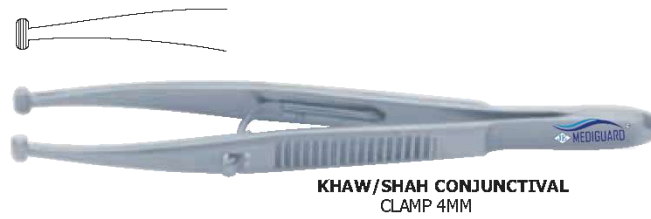
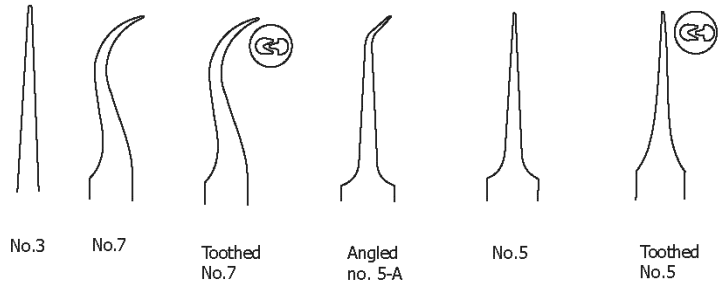



**LENS
FOLDING FORCEPS**
WITH MID JAW INDICATOR
FLAT BODY



**LENS
HOLDING FORCEPS**
NOTCHED TIPS
CATCH
NO CATCH

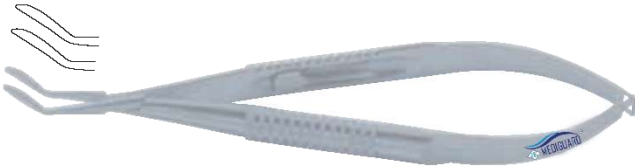

MORCHER
LENS FORCEPS
FOLDING



FIXATION FORCEPS
STRAIGHT
1/2MM TEETH

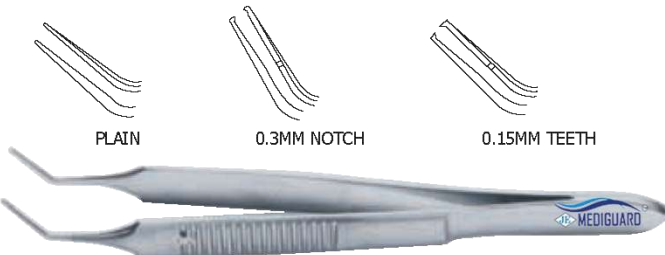

Mc PHERSON
TYING FORCEPS
7MM ANGLED JAWS



CHAUVASSE
FIXATION FORCEPS
STRAIGHT
1.5 5/6 MM TEETH



ST. MARTIN CORNEAL
TYING FORCEPS
STRAIGHT
0.15MM TEETH

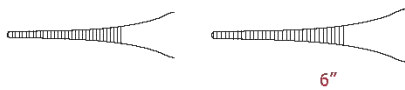

**MICRO ADSON
FORCEPS PLAIN**



**MICRO ADSON
FORCEPS TOOTH**



**ADSON FORCEPS
PLAIN
STAINLESS STEEL
5"**

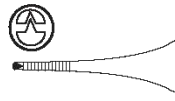

**ADSON FORCEPS
1x2 TOOTH
STAINLESS STEEL
5"**



CASTROVIEJO
NEEDLE HOLDER FLAT
STRAIGHT
CATCH
NO CATCH



CASTROVIEJO
NEEDLE HOLDER FLAT
CURVED
CATCH
NO CATCH



BARRAQUER
NEEDLE HOLDER
CURVED
CATCH
NO CATCH



CASTROVIEJO
NEEDLE HOLDER ROUND
STRAIGHT
CATCH
NO CATCH



CASTROVIEJO
NEEDLE HOLDER ROUND
CURVED
CATCH
NO CATCH



SILCOCK
NEEDLE HOLDER
CATCH



KALT
NEEDLE HOLDER
WITH CATCH

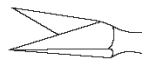

VANNAS SCISSORS
ULTRA FINE BLADES
STRAIGHT



VANNAS SCISSORS
ULTRA FINE BLADES
CURVED



VANNAS SCISSORS
ULTRA FINE BLADES
ANGLED FORWARD



ONG STYLE
CAPSULOTOMY SCISSORS
10MM BLADE LENGTH



WESTCOTT TENOTOMY
SCISSORS
LONG WIDE HANDLE
23MM BLADE LENGTH
BLUNT



WESTCOTT TENOTOMY
SCISSORS
LONG WIDE HANDLE
23MM BLADE LENGTH
SHARP

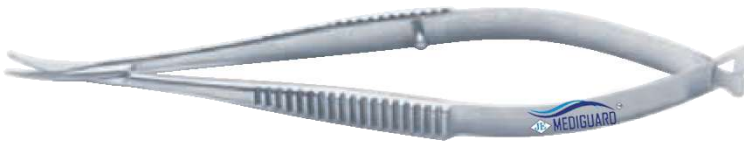

Mc PHERSON-WESTCOTT
SCISSORS
CURVED SHARP TIP
12MM BLADE LENGTH



WILLIAMSON-NOBLE
STRABISMUS SCISSORS
STRAIGHT
27MM BLADE LENGTH



WILLIAMSON-NOBLE
STRABISMUS SCISSORS
CURVED
27MM BLADE LENGTH



CORNEAL SCISSORS
KATZIN 10MM BLADE LENGTH
RIGHT



CORNEAL SCISSORS
KATZIN 10MM BLADE LENGTH
LEFT



CASTROVIEJO MICRO
CORNEAL SCISSORS
12MM BLADE LENGTH



CASTROVIEJO
CORNEAL SCISSORS
CIRCULAR GRAFT
21MM BLADE LENGTH



CAPSULOTOMY
SCISSORS
CURVED ROUND BODY
12MM BLADE LENGTH



CASTROVIEJO
CORNEAL SCISSORS
SQUAR GRAFT
21MM BLADE LENGTH



VANNAS SCISSORS
SMALL
9MM BLADE LENGTH
STRAIGHT



VANNAS SCISSORS
SMALL
9MM BLADE LENGTH
CURVED



MINIATURE RESEARCH
SCISSORS
STRAIGHT LONG HANDLE
12MM BLADE LENGTH



MINIATURE RESEARCH
SCISSORS
STRAIGHT LONG HANDLE
9MM BLADE LENGTH





STITCH RIBBON SCISSORS
CURVED
STAINLESS STEEL

STITCH RIBBON SCISSORS
STRAIGHT
STAINLESS STEEL



IRIS SCISSORS
CURVED
STAINLESS STEEL

IRIS SCISSORS
STRAIGHT
STAINLESS STEEL



KNAPP SCISSOR
CURVED
STAINLESS STEEL

KNAPP SCISSORS
STRAIGHT
STAINLESS STEEL



De WECKER
IRIS SCISSORS
12MM BLADE LENGTH
BOTH BLADES SHARP
RIGHT BLADES SHARP
LEFT BLADES SHARP



BARRAQUER
IRIS SCISSORS
8.5MM BLADE LENGTH



SINSKEY
DIALING HOOK
STRAIGHT SATIN



SINSKEY
DIALING HOOK
ANGLED SATIN



LESTER
LENS PUSHER
STRAIGHT



FENZL HOOK



**DRYSDALE
NUCLEUS MANIPULATOR**



**JAFFE BECHERT
NUCLEUS ROTATOR**



TAMBLYN
NUCLEUS SPLITTR/MANIPULATOR



PHACO CHOPPER
STRAIGHT BLADE



KUGLEN
LENS MANIPULATOR
45° ANGLED TIP



PHACO CLEAVER



JAFFE BECHERT
NUCLEUS ROTATOR
BLUNT "Y" SHAPED TIP
9MM FROM BEND TO TIP



STEVEN DUAL
CUT PHACO CHOPPER
SHARP LEADING AND REAR EDGES



LESTER
LENS PUSHER
ANGLED



HESSBURG
LENS PUSHER STRAIGHT



CARO
MANIPULATOR



KOCH
PHACO MANIPULATOR
AND SPLITTER 0.8MM WIDTH



KELLAN
NUCLEUS SEGMENTOR
PADDLE SHAPED TO SPLIT
NUCLEUS



NORDAN
CAPSULE ELEVATOR
FOR IN-THE BAG
IOL PLACEMENT



NIGHTINGALE
CAPSULE POLISHER
1.75MM DIA.OPEN RING
SEMI-SHARP EDGE
ANTERIOR
POSTERIOR



KANSAS
NUCLEUS TRISECTOR
FOR MANUAL SMALL
INCISION SURGERY



KNOLLE
IRIS HOOK
VERY BLUNT SMALL
STRAIGHT



KUGLEN
IRIS HOOK
AND LENS MANIPULATOR
CLOVER LEAF MODEL



DSEK
DECEMENT'S STRIPPER
FACILITATES EASY REMOVAL OF
DM AS A SINGLE DISK



HIRSHMAN
IRIS HOOK, ANGLED

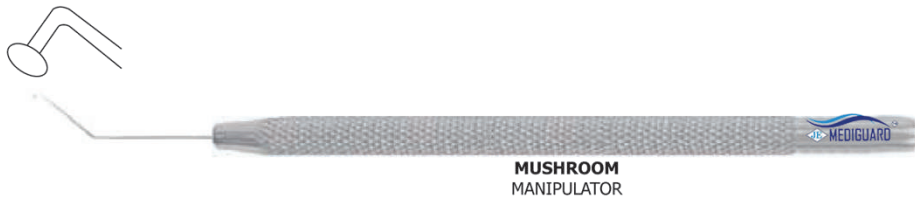



MANIPULATOR/ROTATOR



**TRIPLE
CHOPPER/MUSHROOM
MANIPULATOR**



**GREEN'S
CHOPPER/MUSHROOM
MANIPULATOR**





CAUTERY
BALL POINT
STAINLESS STEEL



CAUTERY
CONE TYPE
STAINLESS STEEL



PIGTAIL PROBE
WITH SUTURE HOLES FOR LOWER
PUNCTUM AND UPPER PUNCTUM



JAMESON
MUSCLE HOOK



GREEN
MUSCLE HOOK



ARRUGA
LENS EXTRACTOR



KIRBY
LENS EXPRESSOR &
VECITS



KIRBY
LENS EXPRESSOR
& REPOSITOR
CP 8143



KIRBY
LENS EXPRESSOR
& SPATULA



DESMARRES
CORNEAL KNIFE



CORNEA
ZONE MARKERS



CORNEA
RADIAL MARKERS
6 BLADES
8 BLADES
12 BLADES



CORNEA
SCLERAL DEPRESSOR



CORNEA
LASIK FLAP LIFTER



DEITZ
 INCISION DEPTH GAUGE
 FOR CORNEAL INCISION
 0.50MM
 0.55MM

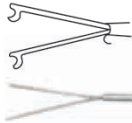

MICRO BEEHLER
 PUPIL DILATOR
 BEEHLER PUPIL DILATOR STRAIGHT 20G,
 THREE STRETCHING POINTS
 STRAIGHT



TRAQUAIR
 PERIOSTEAL ELEVATOR



KRAMER
 CORNEAL FIXATION FORCEPS
 WITH LOCK 'U' SHAPED 13MM
 SPREAD EACH 0.12MM 1X2 TEETH
 STRAIGHT WITH CATCH
 CURVED WITH CATCH



UTRATA
 FOLDABLE LENS
 CUTTER SNARE LOOP



KALLEN
 FOLDABLE IOL FORCEPS
 DESIGNED TO CONTOUR
 THE SILICONE IOL RATHER
 THAN FOLD THE IOL



FAULKNER
LENS INSERTING FORCEPS FOR
FOLDING AND INSERTING SOFT
IOLs THROUGH SMALL INCISION



MOORFIELDS
STRABISMUS HOOK



SNELLEN VECTIS



BELL TAYLOR
VECTIS



CASTROVIEJO
SYSLODIALYSIS / SYNECHIA
SPATULA DOUBLE ENDED
10MM & 15MM
0.5MM WIDE

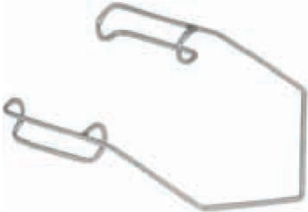

BARRAQUER SPECULUM
ADULT



KRATZ BARRAQUER
SPECULUM
TEMPORAL



LANCASTER
SPECULUM

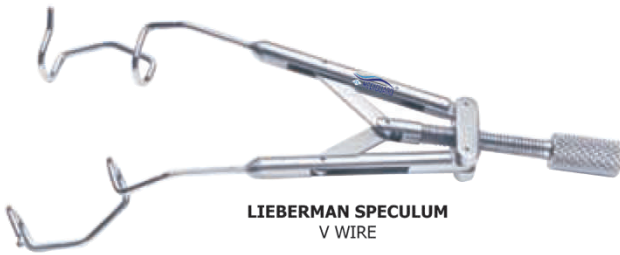

LIEBERMAN SPECULUM
V WIRE

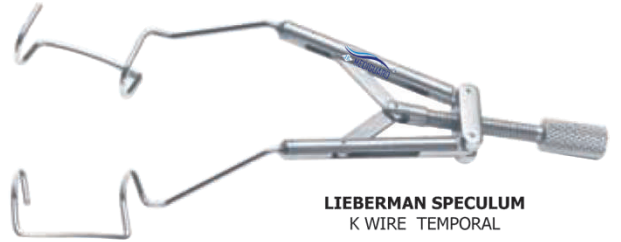

LIEBERMAN SPECULUM
K WIRE TEMPORAL



LIEBERMAN SOLID BLADE
SPECULUM



CLARKE SPECULUM
ADULT
CHILD



**SCHEPENS
SCLERAL DEPRESSOR
WITH THIMBLE**
SMALL No. 8
MEDIUM No. 10
LARGE No. 12



**BARRAQUER WIRE SPECULUM
WITH SOLID BLADES**
SMALL
BIG

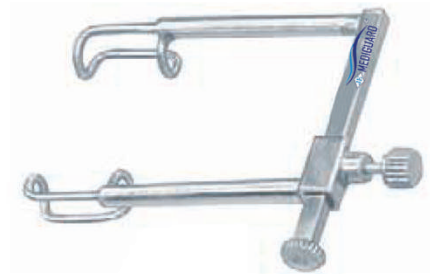

**MURDOCK
EYE SPECULUM**
FENESTRATED WITH LOCKING SCREW
SMALL No. 1
MEDIUM No. 2
LARGE No. 3



**COOK
EYE SPECULUM**
WITH LOCKING SCREW **SOLID**
SMALL No. 1
MEDIUM No. 2
LARGE No. 3



**MUELLER LACRIMAL
SAC RETRACTOR**
SPRING ACTION WITH SCREW LOCK
3X3 SHARP PRONGS



ARRUGA LACRIMAL TREPHINE
"T" HANDLE WITH SHARP
CUTTING EDGE
USED FOR CUTTING THE BONE
WITH PIN FOR PRIMARY
7MM WITH CENTER PIN
8MM WITH CENTER PIN

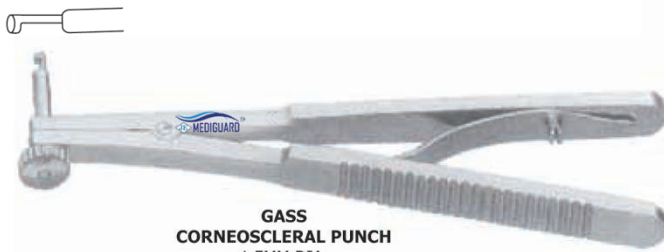

**GASS
CORNEOSCLERAL PUNCH**
1.5MM DIA.
TIP ROTATABLE FOR CONVENIENT
POSITIONING



AKAHOSHI PHACO PRE CHOPPER
SMOOTH FLATTENED POINTED TIPS
OPEN TO 3MM STRAIGHT
ROUND HANDLE FOR CRACKING
STRAIGHT



AKAHOSHI PHACO PRE CHOPPER
SMOOTH FLATTENED POINTED TIPS
OPEN TO 3MM STRAIGHT
ROUND HANDLE FOR CRACKING
ANGLED



AKAHOSHI COMBO PRE CHOPPER
FOR CRACKING,
DIVIDING AND ROTATING THE NUCLEUS
WITHOUT SCULPTING
STRAIGHT



AKAHOSHI PHACO PRE CHOPPER
WITH FLATTENED POINTED TIPS
ANGLED, GENTLY CURVED



AKAHOSHI HYBRID PRE CHOPPER
SHARPENED ANGULAR EDGE
STRAIGHT



THORNTON
GLOBE FIXATION RING
MULTIPLE TEETH, 16MM DIAMETER



**THORNTON
GLOBE FIXATION RING**
MULTIPLE TEETH, 16MM DIAMETER
OPEN



**SHEPARD
FIXATION RING**
CLEAR CORNEA INCISION
12 TEETH, PIVOT SWIVEL ABLE
16MM DIAMETER



**GLOBE FIXATION RING
WITH CONCENTRIC**
GROOVES FOR STABILIZING THE GLOBE
DURING **PRK** AND **LASIK** PROCEDURE

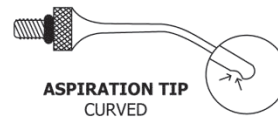



SMALL



LARGE

DESMARRES
LID RETRACTOR



MEIBOMAIN
CYST CURETTE
DOUBLE ENDED



TOOKE KNIFE
FOR CORNEAL SPLITTING
OR
SCRAPING DURING LASER PROCEDURE



CHALAZION
CLAMP



AYRES
TARSAL CYST FORCEPS
ROUND PLATE
7MM DIAMETER



DESMARRES
ENTROPIUM FORCEPS
28MM WIDE PLATE
RIGHT
LEFT



ENTROPIUM
LID PLATE



SHARP SPOON
FOR CORNEAL ULCERS AND TARSAL CYSTS
SIZE OVAL
3X2.2MM



LACRIMAL PROBE
SET OF 3



**LACRIMAL
DILATOR**
SET OF 3



1mm STRAIGHT



2mm STRAIGHT



3mm STRAIGHT



KERRISON PUNCH
UPWARD CUTTING

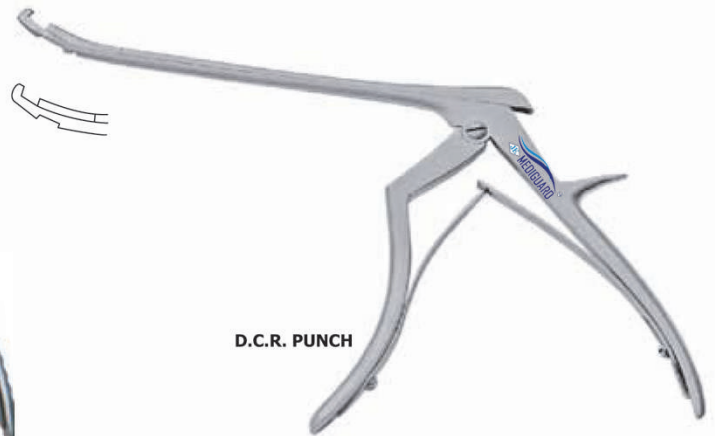

D.C.R. PUNCH

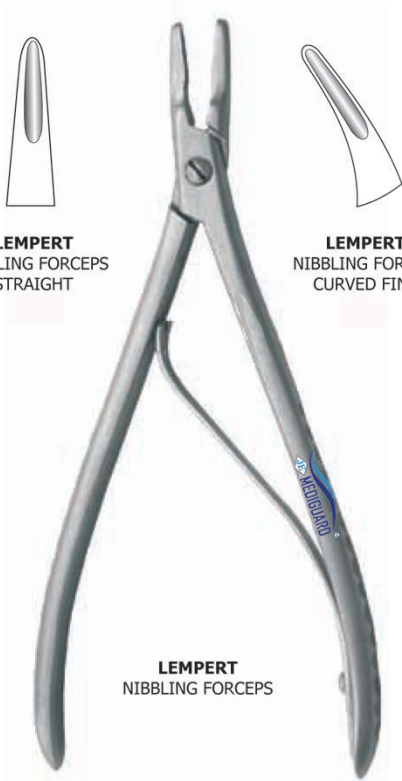

LEMPERT
NIBBLING FORCEPS
STRAIGHT

LEMPERT
NIBBLING FORCEPS
CURVED FINE

LEMPERT
NIBBLING FORCEPS



KILLIAN NASAL SPECULUM
5CM, 6.5CM, 7.5CM, 9CM

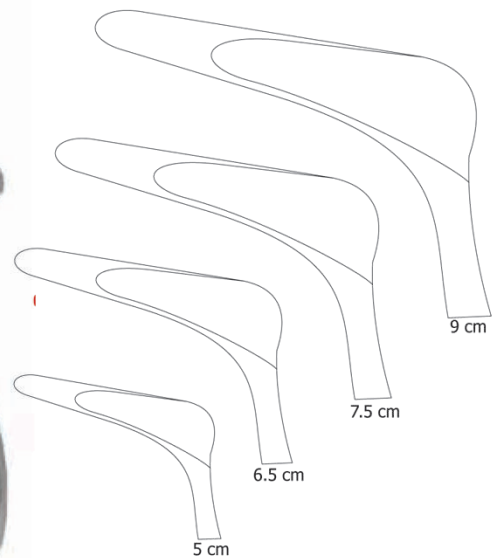

9 cm

7.5 cm

6.5 cm

5 cm



LACRIMAL INTUBATION SET
11CM PROBES
STERILE



KNAPP
LACRIMAL SAC RETRACTOR
WITH BLUNT PRONGS



MALLET



STRAIGHT CHISELS

- 2MM
- 3MM
- 4MM
- 6MM
- 8MM
- 10MM



CURVED CHISELS

- 2MM
- 3MM
- 4MM
- 6MM
- 7MM
- 8MM



WELLS ENUCLEATION
SPOON



VITREOUS FORCEPS
SERRATED JAWS
STRAIGHT
20 GAUGE



VITREOUS FORCEPS
SMOOTH JAWS
STRAIGHT
20 GAUGE



VITREOUS FORCEPS
SMOOTH JAWS VERTICAL
20 GAUGE



STEVENS LACRIMAL
SAC RETRACTOR



RULER

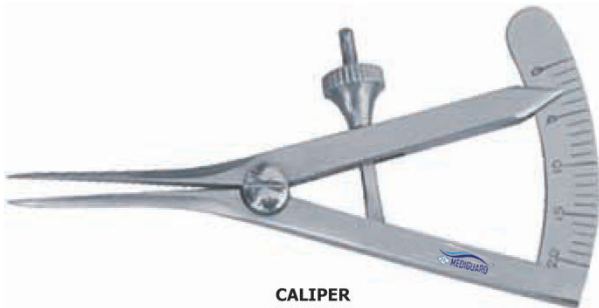

**CALIPER
STRAIGHT**



**CALIPER
CURVED**



STRAIGHT

**SERREFINE
SERRATED JAWS
1.5" 38MM LONG**



CURVED



**JAMESON
CALIPER CHROME PLATED BRASS**



**CASTROVIEJO
CORNEAL TREPHINE WITH ADJUSTABLE STOP**

- | | |
|---------------|-----------------|
| SIZE 5MM DIA | SIZE 5.5MM DIA |
| SIZE 6MM DIA | SIZE 6.5MM DIA |
| SIZE 7MM DIA | SIZE 7.5MM DIA |
| SIZE 8MM DIA | SIZE 8.5MM DIA |
| SIZE 9MM DIA | SIZE 9.5MM DIA |
| | SIZE 10MM DIA |
| SIZE 11MM DIA | SIZE 11.5MM DIA |
| SIZE 12MM DIA | SIZE 12.5MM DIA |

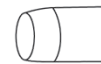

**DISPOSABLE CORNEAL TREPHINE
SEE THROUGH**

- | | |
|---------------|-----------------|
| SIZE 6MM DIA | SIZE 6.5MM DIA |
| SIZE 7MM DIA | SIZE 7.5MM DIA |
| SIZE 8MM DIA | SIZE 8.5MM DIA |
| SIZE 9MM DIA | SIZE 9.5MM DIA |
| SIZE 10MM DIA | SIZE 10.5MM DIA |
| | SIZE 11MM DIA |



CAP TO PROTECT
WHEN NOT IN USE

GLAUCOMA
KELLY PUNCH
1MM DIAMETER TIP



BARD PARKER BLADES
No. 10, 11, 12, 15



BARD PARKER
HANDLE No. 3



BARD PARKER
HANDLE No. 7



B.P. HANDLE
ROUND

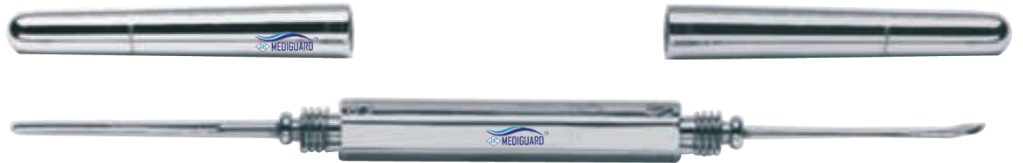

FOREIGN BODY
NEEDLE AND SPUD



CASTROVIEJO
BLADE BREAKER/HOLDER
12CM HANDLE



BARRAQUER
BLADE BREAKER
SPRING LOCK,
SMOOTH FLAT BLADES

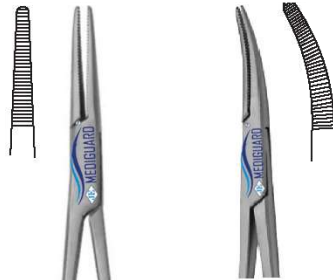

**MOSQUITO FORCEPS
CURVED**



**MOSQUITO FORCEPS
STRAIGHT**



CHEATLE JAR



CHEATLE FORCEPS

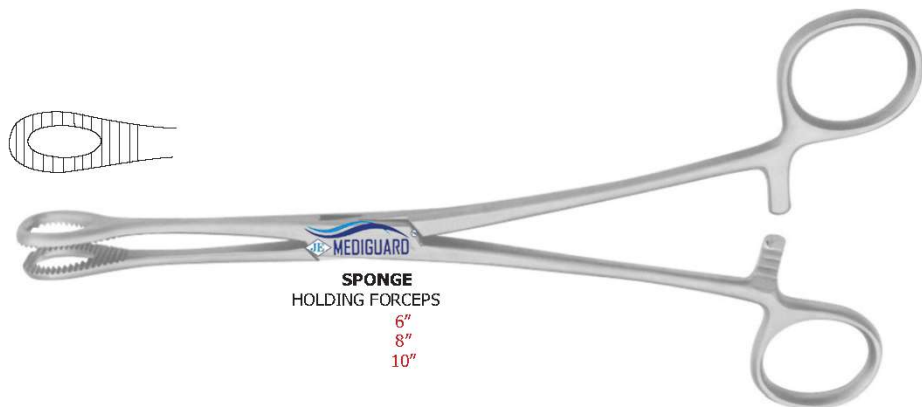
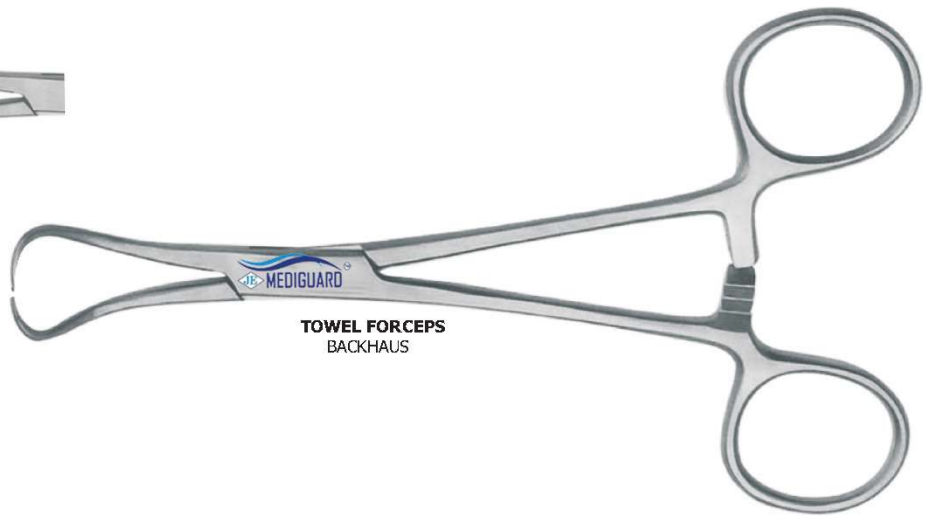

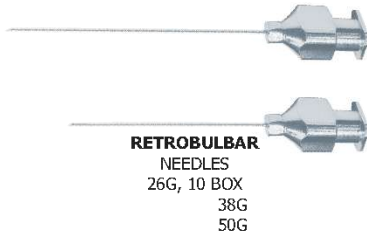

**RETROBULBAR
NEEDLES**
26G, 10 BOX
38G
50G

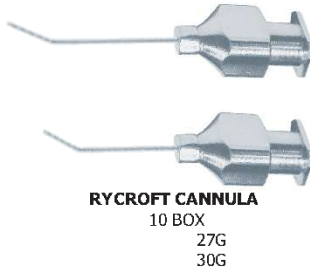

RYCROFT CANNULA
10 BOX
27G
30G



IRRIGATING VECTIS
SINGLE HOLE
STRAIGHT, 24G



**Mc INTYRE-BINKHORST
CANNULA**
BLUNT TIP 26G
RIGHT
LEFT

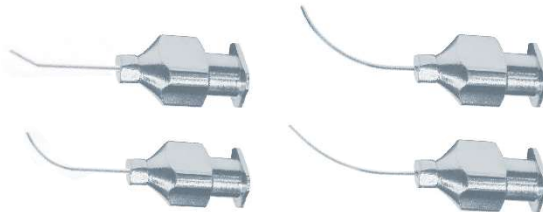

**AIR INJECTION
CANNULA**
23G CURVED
25G STANDARD CURVED
27G FRANKFURT CURVED
27G ANGLED

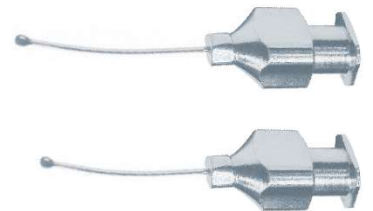

**JENSON
CAPSULE POLISHER**
23G
27G

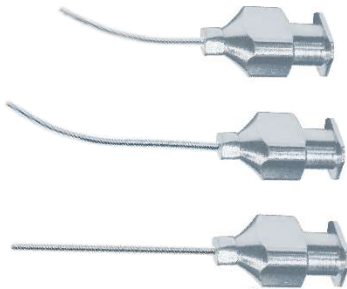

LACRIMAL CANNULA
STRAIGHT 23G
DUGGAN CURVED 23G
HARRISON BUTLER 24G

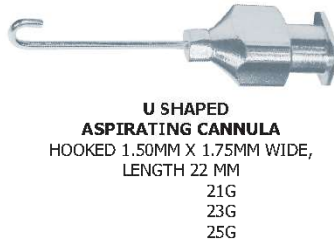

**U SHAPED
ASPIRATING CANNULA**
HOOKED 1.50MM X 1.75MM WIDE,
LENGTH 22 MM
21G
23G
25G



**SIMCOE I/A
CANNULA, 23G**
0.3MM ASPIRATION PORT
REVERSED 0.3MM ASPIRATION PORT
0.4MM ASPIRATION PORT
REVERSED 0.4MM ASPIRATION PORT
POLISHING TIP 0.3MM ASPIRATION PORT
POLISHING TIP 0.4MM ASPIRATION PORT



**SILICONE BULB
WITH ADAPTOR**

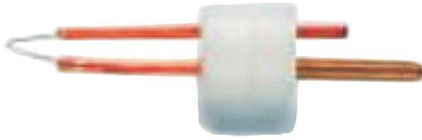

**CAUTERY
BURNER**

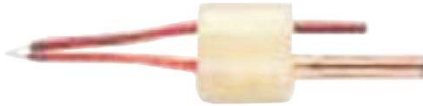

**CAUTERY
BURNER DIXEY**



**CAUTERY BURNER
BURNER
RED HEAD**



**AUTOCLAVE
INSTRUMENT
BOX WITH SILICON MATT**



**EPILATION NEEDLES
STERILE
STRAIGHT BOX OF 50**



**BIPOLAR CABLE
TWO PIN**



**BIPOLAR CABLE
ROUND PIN**



**BIPOLAR CABLE
FLAT PIN**



**BIPOLAR CABLE
TWO PIN**

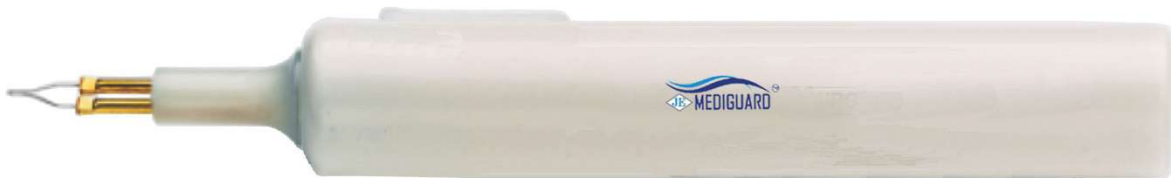

**CAUTERY
DISPOSABLE, STERILE 10 BOX**

MICROSURGERY CATARACT & IOL SET

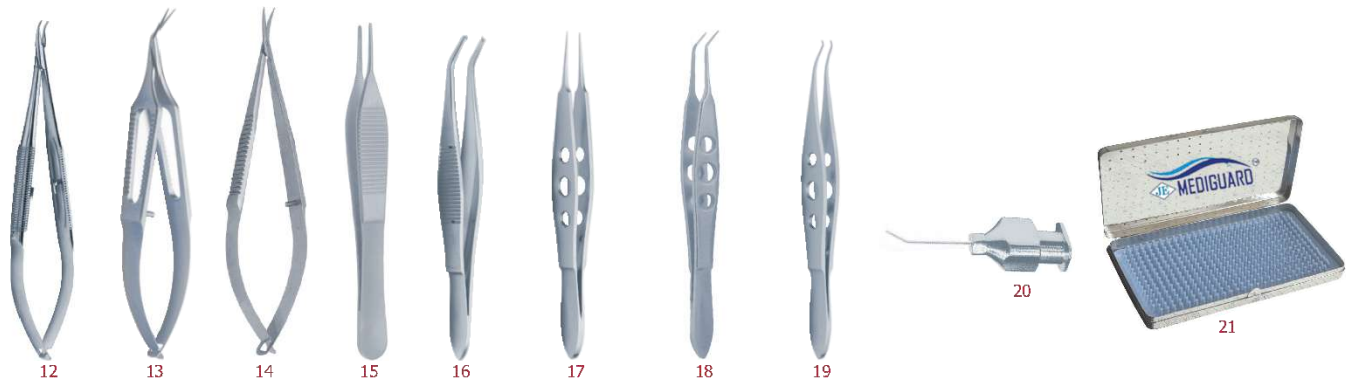
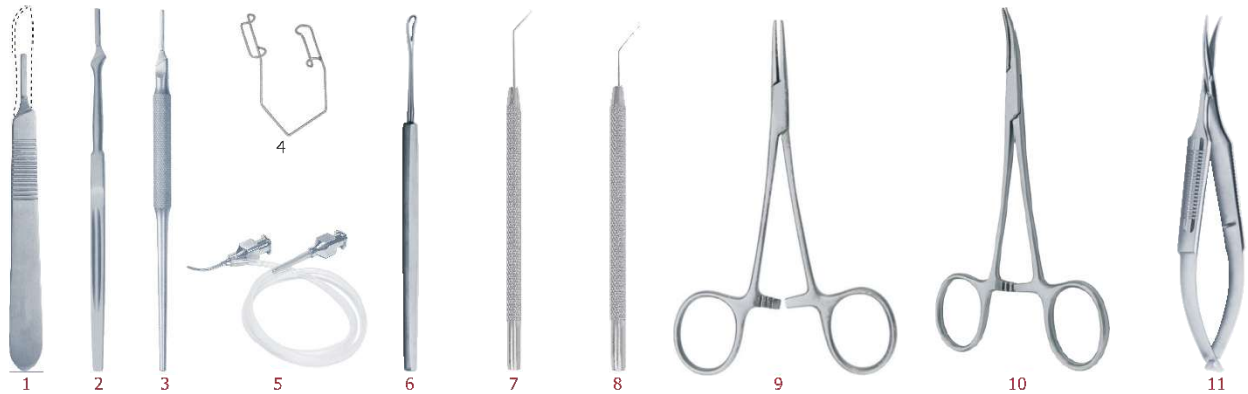

- 1. BARD PARKER HANDLE No. 3
- 2. BARD PARKER HANDLE NO. 7
- 3. B.P HANDLE ROUND
- 4. BARRAQUER WIRE SPECULUM ADULT
- 5. SIMCOE I/A CANNULA 23G
- 6. SNELLEN VECTIS
- 7. SINSKEY DIALING HOOK ANGLED SATIN
- 8. PHACO CHOPPER STRAIGHT BLADE
- 9. MOSQUITO FORCEPS STRAIGHT
- 10. MOSQUITO FORCEPS CURVED
- 11. WESTCOTT TENOTOMY SCISSORS

- 12. BARRAQUER NEEDLE HOLDER
- 13. ONG STYLE SCISSOR
- 14. CASTROVIEJO MICRO CORNEAL SCISSOR
- 15. ADSON FORCEPS PLAIN
- 16. TROUTMAN SUPERIOR RECTUS FORCEPS
- 17. CASTROVIEJO TYING FORCEPS TEETH
- 18. Mc PHERSON TYING FORCEPS
- 19. CASTROVIEJO COLIBRI TYING FORCEPS
- 20. AIR INJECTION CANNULA
- 21. AUTOCLAVE INSTRUMENT BOX WITH SILICON MATT

EXTRACAPSULAR CATARACT EXTRACTION SET (ECCE)



- | | | | | | |
|-----|-------------------------------|-----|-----------------------------------|-----|--|
| 1. | BARD PARKER HANDLE No. 3 | 2. | BARD PARKER HANDLE NO. 7 | 3. | B.P HANDLE ROUND |
| 4. | KUGLEN LENS MANIPULATOR | 5. | TOOKS KNIFE | 6. | LENS EXPRESSOR |
| 7. | SNELLEN VECTIS | 8. | SINSKEY DIALING HOOK ANGLED SATIN | 9. | PHACO CHOPPER STRAIGHT BLADE |
| 10. | MOSQUITO FORCEPS STRAIGHT | 11. | MOSQUITO FORCEPS CURVED | 12. | WESTCOTT TENOTOMY SCISSORS |
| 13. | BARRAQUER NEEDLE HOLDER | 14. | ONG STYLE SCISSOR | 15. | CASTROVIEJO MICRO CORNEAL SCISSOR |
| 16. | ADSON FORCEPS PLAIN | 17. | TROUTMAN SUPERIOR RECTUS FORCEPS | 18. | CASTROVIEJO TYING FORCEPS TEETH |
| 19. | Mc PHERSON FORCEPS ANGLED | 20. | CASTROVIEJO COLIBRI TYING FORCEPS | 21. | SLIMLINE COLIBRI FORCEPS |
| 22. | RYCROFT CORNEAL FORCEPS TEETH | 23. | ST. MARTIN CORNEAL TYING FORCEPS | 24. | Mc PHERSON TYING FORCEPS |
| 25. | CALIPER STRAIGHT | 26. | TOWEL CLIP CROSS ACTION | 27. | SERREFINE SERRATED JAW STRAIGHT |
| 28. | CORNEAL SCISSOR KATZIN RIGHT | 29. | CORNEAL SCISSOR KATZIN LEFT | 30. | CAPSULOTOMY SCISSOR CURVED ROUND |
| 31. | BARRAQUER IRIS SCISSORS BODY | 32. | WESTCOTT TENOTOMY SCISSORS | 31. | IRIS SCISSOR STRAIGHT |
| 34. | KALT NEEDLE HOLDER WITH CATCH | 35. | RYCROFT CANNULA 27G | 33. | RYCROFT CANNULA 30G |
| 37. | LACRIMAL CANNULA | 38. | JENSEN CAPSULE POLISHER | 36. | IRRIGATING VECTIS |
| 40. | AIR INJECTION CANNULA | 41. | BARRAQUER WIRE SPECULUM ADULT | 37. | AUTOCLAVE INSTRUMENT BOX WITH SILICON MATT |
| 43. | SILICONE BULB WITH ADAPTOR | | | 40. | |
| | | | | 42. | |
| | | | | 43. | |

MICROSURGERY ECCE-PHACO EMULSIFICATION SET

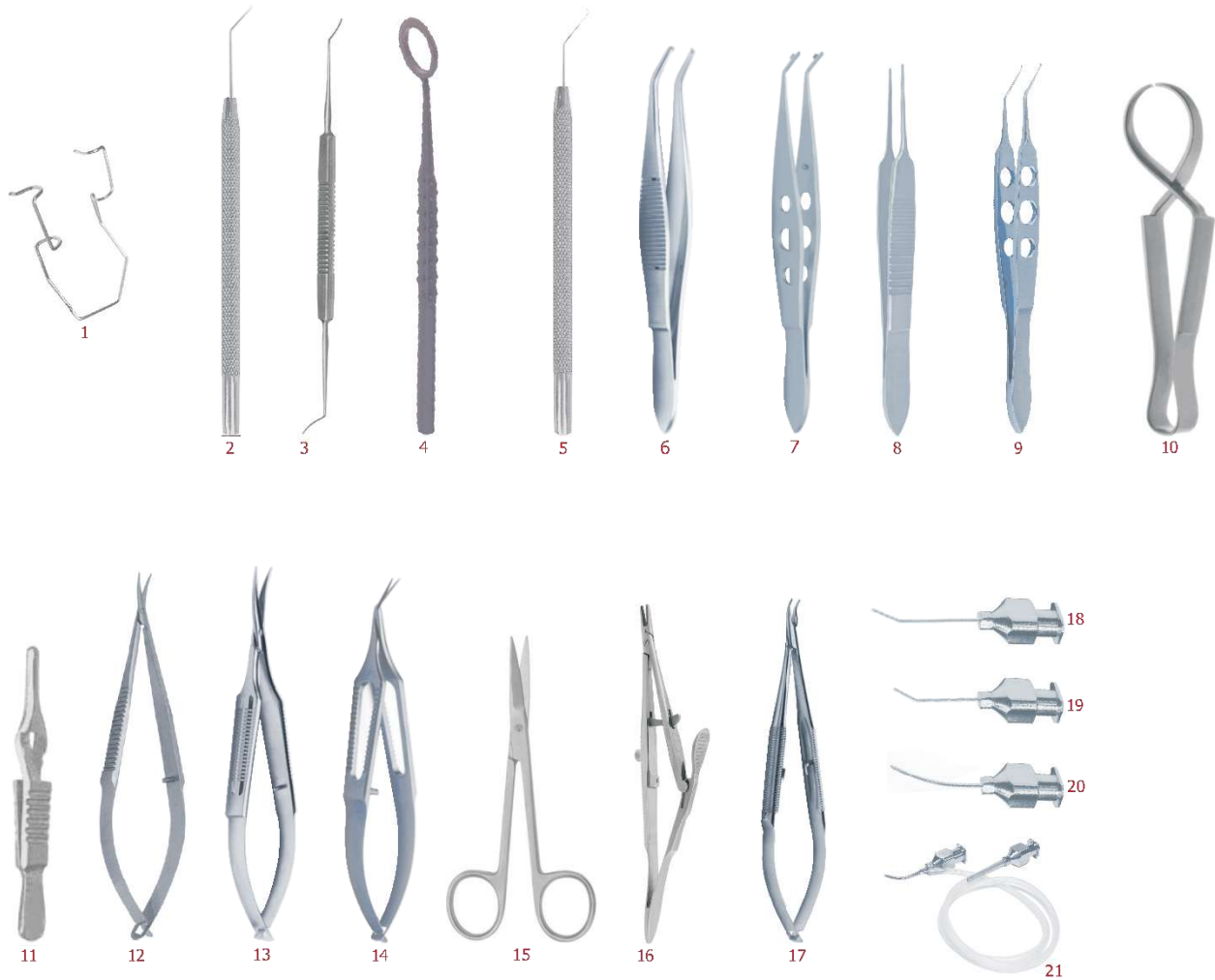

- | | | | |
|-----|-----------------------------------|-----|-----------------------------------|
| 1. | KRATZ BARRAQUER SPECULUM TEMPORAL | 12. | CASTROVIEJO MICRO CORNEAL SCISSOR |
| 2. | SINSKEY DIALING HOOK ANGLED SATIN | 13. | WESTCOTT TENOTOMY SCISSORS |
| 3. | CASTROVIEJO SYNECHIAE SPATULA | 14. | ONG STYLE SCISSOR |
| 4. | CORNEAL TREPINE | 15. | IRIS SCISSOR STRAIGHT |
| 5. | PHACO CHOPPER STRAIGHT BLADE | 16. | KALT NEEDLE HOLDER WITH CATCH |
| 6. | TROUTMANN SUPERIOR RECTUS FORCEPS | 17. | BARRAQUER NEEDLE HOLDER |
| 7. | LENS FOLDING FORCEPS | 18. | RYCROFT CANNULA 30G |
| 8. | MC PHERSON TYING FORCEPS | 19. | RYCROFT CANNULA 27G |
| 9. | UTRATA CAPSULORHEXIS FORCEPS | 20. | LACRIMAL CANNULA |
| 10. | TOWEL CLIP CROSS ACTION | 21. | SIMCOE I/A CANNULA 23G |
| 11. | SERREFINE SERRATED JAW STRAIGHT | | |

INTRACAPSULAR CATARACT EXTRACTION SET (ICCE)

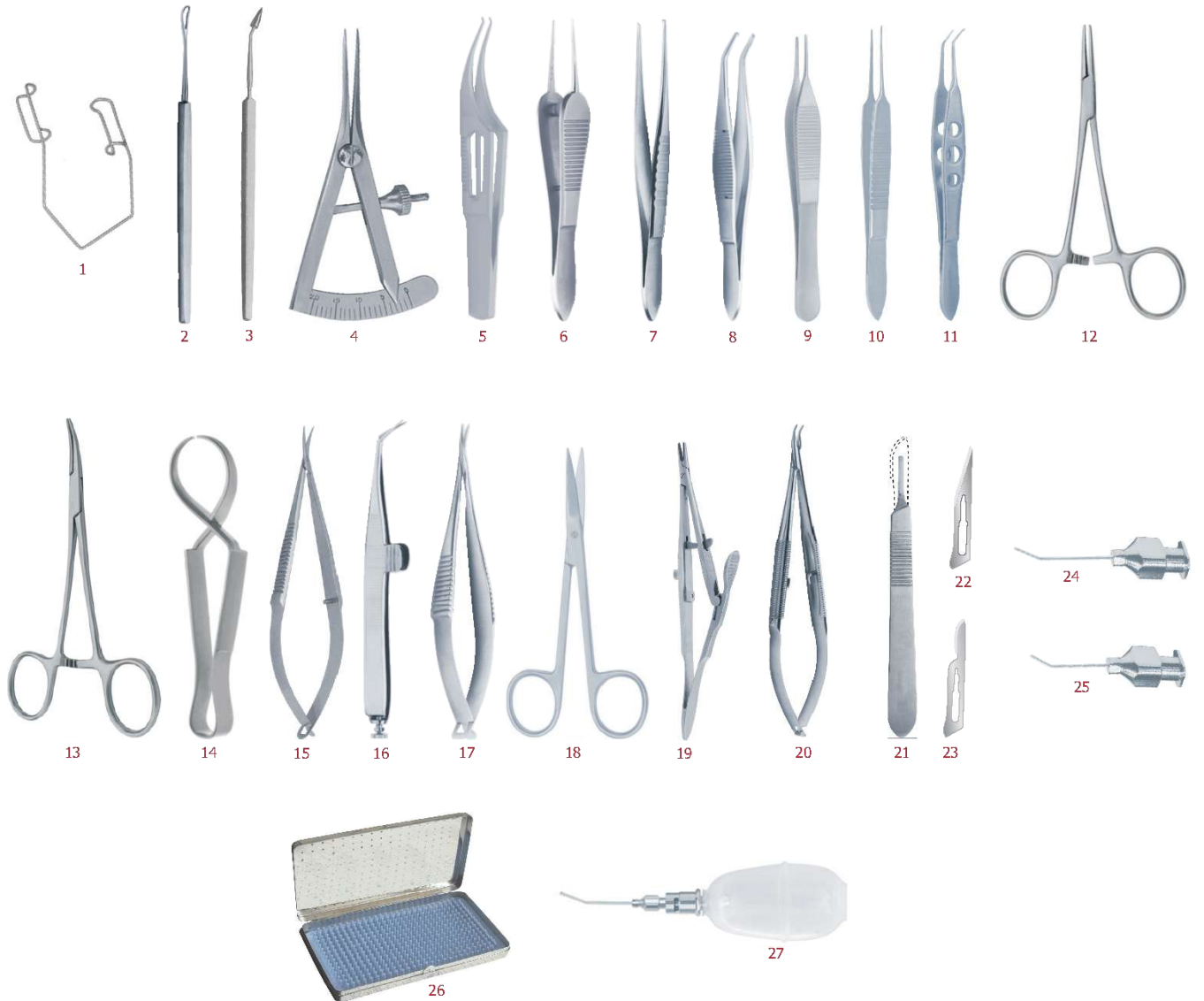

- | | | | | | | |
|-----|-------------------------------|-----|--|-----|---------|-----------------------------------|
| 1. | BARRAQUER WIRE SPECULUM ADULT | 2. | SNELLEN VECTIS | 3. | OP-8137 | CAUTERY CONE TYPE |
| 4. | CALIPER STRAIGHT | 5. | COLIBRI FORCEPS | 6. | OP-8059 | ST. MARTIN CORNEAL TYING FORCEPS |
| 7. | FIXATION FORCEPS TEETH | 8. | TROUTMAN RECTUS FORCEPS | 9. | 1032 | ADSON FORCEPS PLAIN |
| 10. | Mc PHERSON TYING FORCEPS | 11. | Mc PHERSON FORCEPS ANGLED | 12. | 6089 | MOSQUITO FORCEPS STRAIGHT |
| 13. | MOSQUITO FORCEPS CURVED | 14. | TOWEL CLIP CROSS ACTION | 15. | OP-8083 | CASTROVIEJO MICRO CORNEAL SCISSOR |
| 16. | DE WEAVER IRIS SCISSOR | 17. | VANNAS SCISSOR SMALL CURVED | 18. | 2058 | IRIS SCISSOR STRAIGHT |
| 19. | KALT NEEDLE HOLDER WITH CATCH | 20. | BARRAQUER NEEDLE HOLDER | 21. | 5052 | BARD PARKER HANDLE No. 3 |
| 22. | BARD PARKER BLADE NO. 11 | 23. | BARD PARKER BLADE NO. 15 | 24. | OP-8253 | RYCROFT CANNULA 27G |
| 25. | RYCROFT CANNULA 30G | 26. | AUTOCLAVE INSTRUMENT BOX WITH SILICON MATT | 27. | OP-8273 | SILICONE BULB WITH ADAPTOR |

MICROSURGERY GLAUCOMA SET

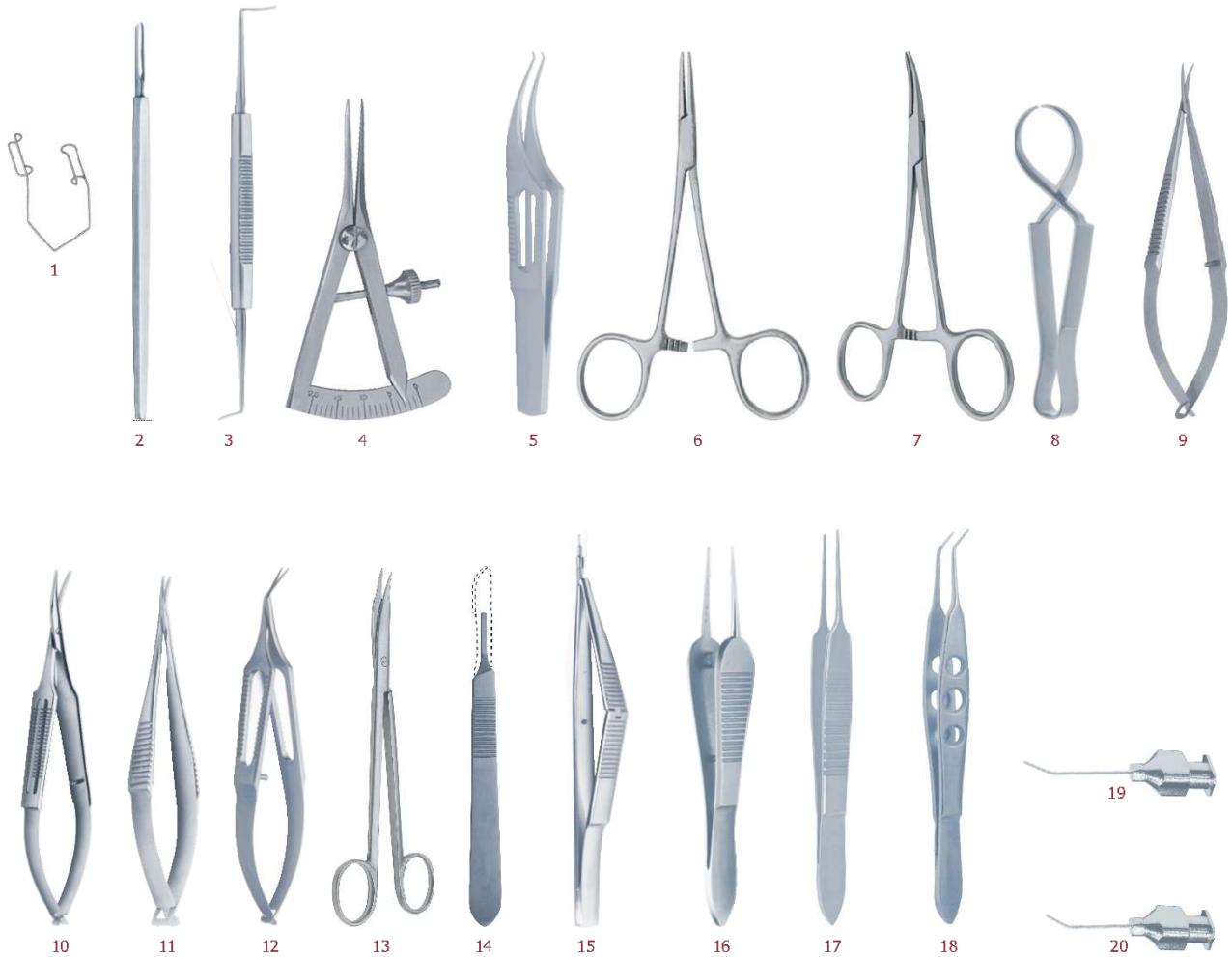

- | | | | |
|-----|---|-----|----------------------------------|
| 1. | BARRAQUER WIRE SPECULUM ADULT | 2. | TOOKS KNIFE |
| 3. | CASTROVIEJO CYCLODIALYSIS/SYVECHIA SPATULA DOUBLE ENDED | 4. | CALIPER STRAIGHT |
| 5. | SLIMLINE COLIBRI FORCEPS | 6. | MOSQUITO FORCEPS STRAIGHT |
| 7. | MOSQUITO FORCEPS CURVED | 8. | TOWEL CLIP CROSS ACTION |
| 9. | CASTROVIEJO MICRO CORNEAL SCISSOR | 10. | WESTCOTT TENOTOMY SCISSORS |
| 11. | VANNAS SCISSOR SMALL CURVED | 12. | ONG STYLE SCISSOR |
| 13. | STEVEN SCISSOR CURVED | 14. | BARD PARKER HANDLE No. 3 |
| 15. | GLAUCOMA KELLY PUNCH | 16. | ST. MARTIN CORNEAL TYING FORCEPS |
| 17. | Mc PHERSON TYING FORCEPS | 18. | Mc PHERSON FORCEPS ANGLED |
| 19. | RYCROFT CANNULA 30G | 20. | RYCROFT CANNULA 27G |

MICROSURGERY CORNEAL TRANSPLANT SET

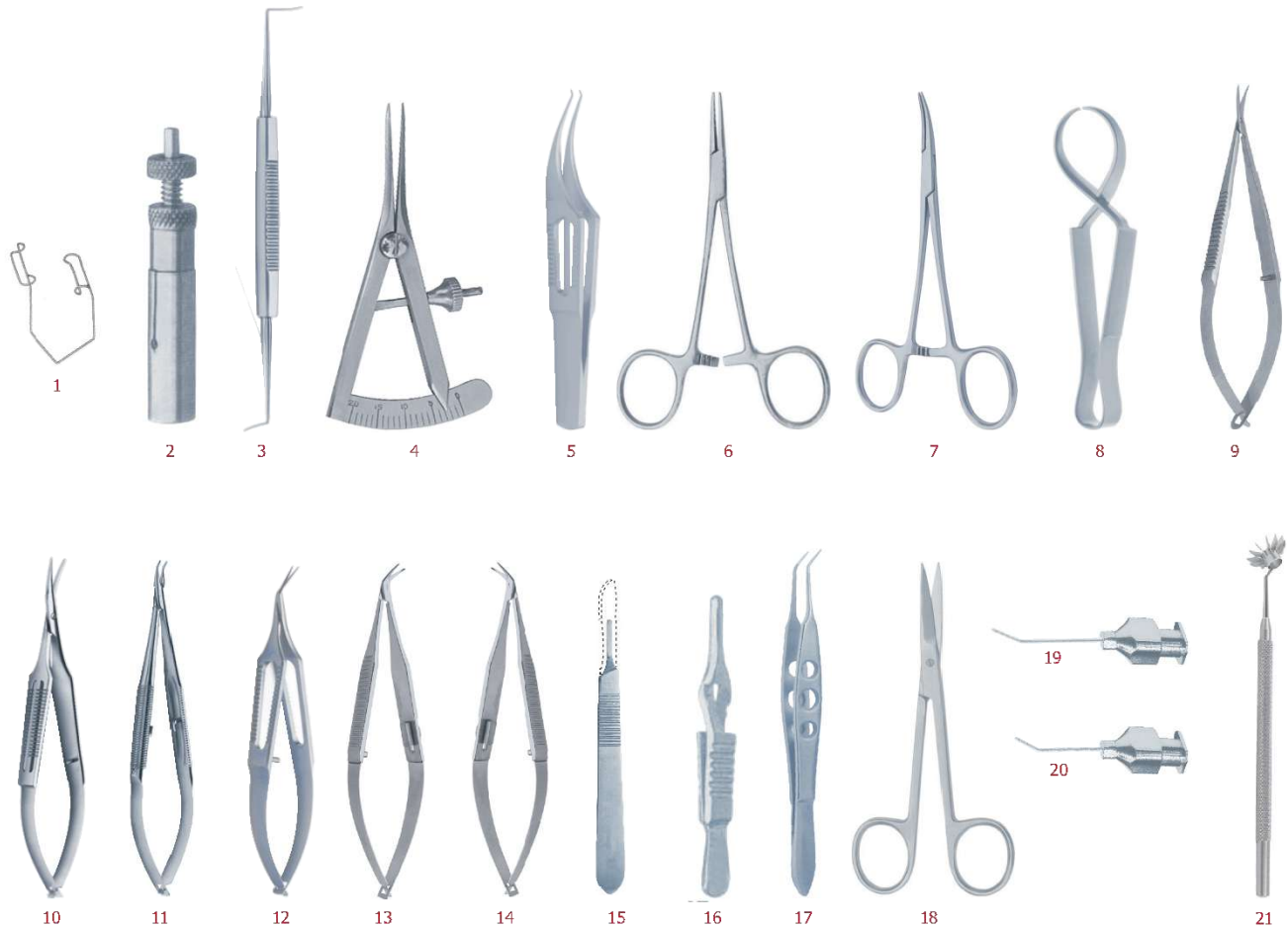

- | | | | |
|-----|---|-----|---|
| 1. | BARRAQUER WIRE SPECULUM ADULT | 2. | CASTROVIEJO CORNEAL TREPHINE SIZE 7.5MM |
| 3. | CASTROVIEJO CYCLODIALYSIS/SYVECHIA SPATULA DOUBLE ENDED | 4. | CALIPER STRAIGHT |
| 5. | SLIMLINE COLIBRI FORCEPS | 6. | MOSQUITO FORCEPS STRAIGHT |
| 7. | MOSQUITO FORCEPS CURVED | 8. | TOWEL CLIP CROSS ACTION |
| 9. | CASTROVIEJO MICRO CORNEAL SCISSOR | 10. | WESTCOTT TENOTOMY SCISSORS |
| 11. | BARRAQUER NEEDLE HOLDER | 12. | ONG STYLE SCISSOR |
| 13. | CORNEAL SCISSOR KATZIN RIGHT | 14. | CORNEAL SCISSOR KATZIN LEFT |
| 15. | BARD PARKER HANDLE No. 3 | 16. | SERREFINE SERRATED JAW STRAIGHT |
| 17. | Mc PHERSON TYING FORCEPS | 18. | IRIS SCISSOR STRAIGHT |
| 19. | RYCROFT CANNULA 30G | 20. | RYCROFT CANNULA 27G |
| 21. | CORNEA RADIAL MARKERS 8 BLADES | | |

MICROSURGERY LACRIMAL SET (DCR)

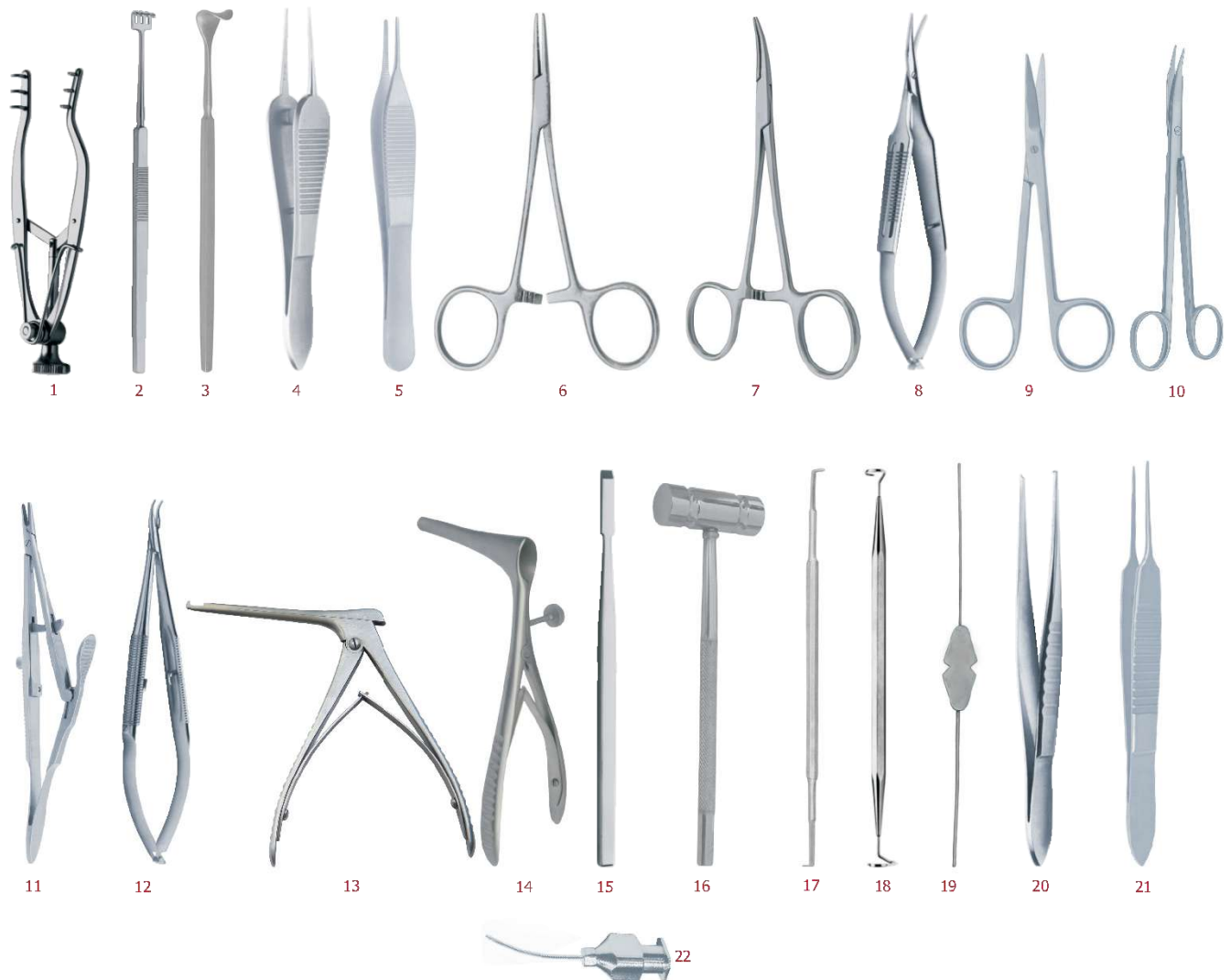

- 1. STEVEN LACRIMAL SAC RETRACTOR
- 3. COTTLE UPPER RETRACTOR
- 5. ADSON FORCEPS PLAIN
- 7. MOSQUITO FORCEPS CURVED
- 9. IRIS SCISSOR STRAIGHT
- 11. KALT NEEDLE HOLDER WITH CATCH
- 13. KERRISON PUNCH UPWARD CUTTING
- 15. STRAIGHT CHISELS
- 17. TRAQUAIR PERIOSTEAL ELEVATOR
- 19. D.C.R PROBE
- 21. Mc PHERSON TYING FORCEPS

- 2. KNAPP LACRIMAL SAC RETRACTOR WITH BLUNT PRONGS
- 4. ST. MARTIN CORNEAL TYING FORCEPS
- 6. MOSQUITO FORCEPS STRAIGHT
- 8. WESTCOTT TENOTOMY SCISSORS
- 10. STEVEN SCISSOR CURVED
- 12. BARRAQUER NEEDLE HOLDER
- 14. KILLIAN NASAL SPECULUM
- 16. MALLET
- 18. PIGTAIL PROBE WITH HOLES HEXAGONAL HANDLE
- 20. FIXATION FORCEPS
- 22. LACRIMAL CANNULA CURVED

MICROSURGERY RETINA SET

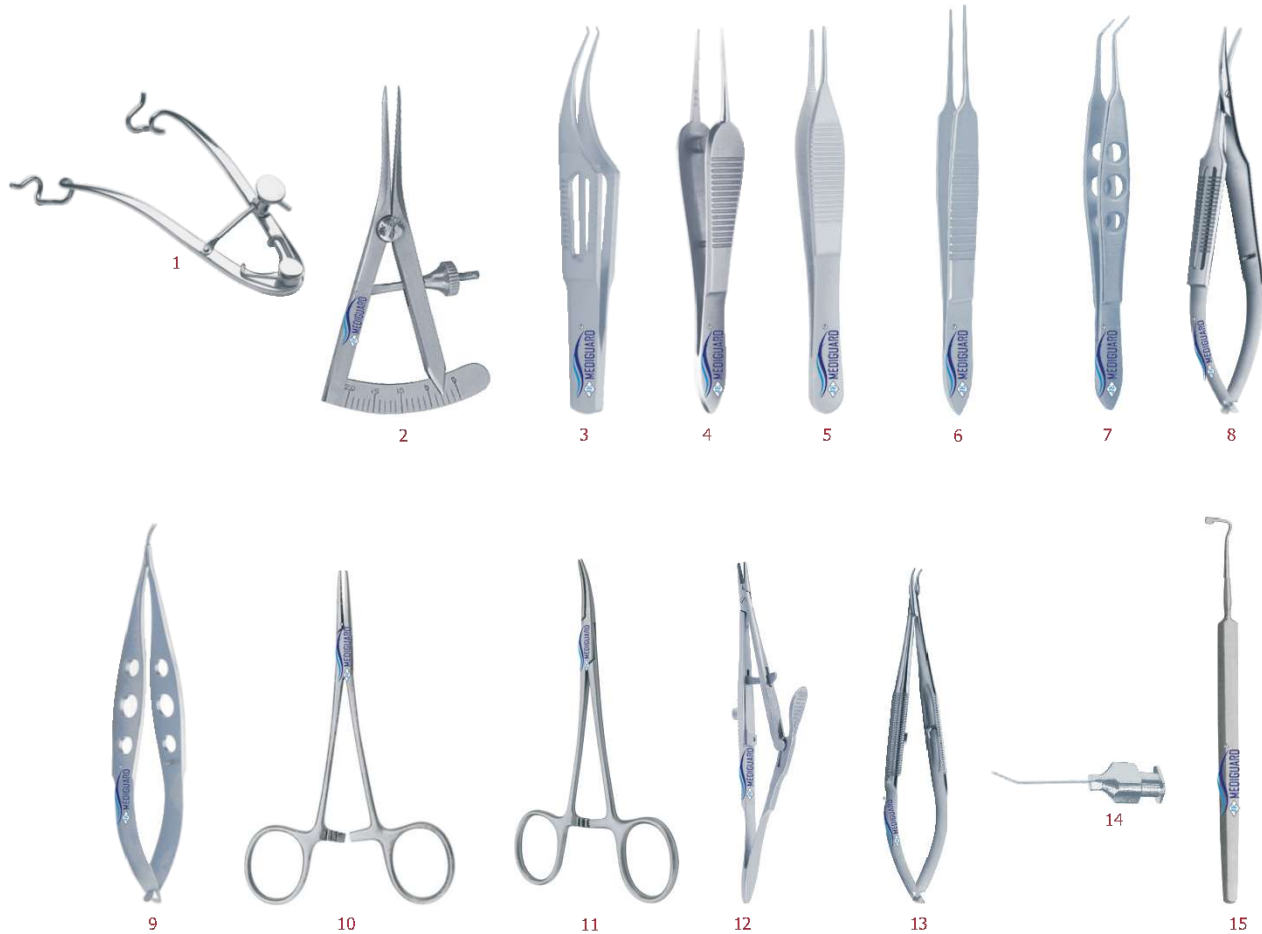

- | | | | |
|-----|--------------------------|-----|----------------------------------|
| 1. | CLARKE SPECULUM CHILD | 2. | CALIPER STRAIGHT |
| 3. | SLIMLINE COLIBRI FORCEPS | 4. | ST. MARTIN CORNEAL TYING FORCEPS |
| 5. | ADSON FORCEPS PLAIN | 6. | Mc PHERSON TYING FORCEPS |
| 7. | Mc PHERSON TYING FORCEPS | 8. | WESTCOTT TENOTOMY SCISSORS |
| 9. | VANNAS SCISSOR CURVED | 10. | MOSQUITO FORCEPS STRAIGHT |
| 11. | MOSQUITO FORCEPS CURVED | 12. | KALT NEEDLE HOLDER WITH CATCH |
| 13. | BARRAQUER NEEDLE HOLDER | 14. | |
| 15. | JAMESON MUSCLE HOOK | 15. | RYCROFT CANNULA 30G |

THE MARK OF QUALITY & CRAFTSMANSHIP



**DERMATOLOGY
SURGICAL
INSTRUMENTS**

**The House Known For
Surgical Instruments**



JULLUNDUR ENTERPRISES

Manufacturer & Exporter Of Surgical Instruments





DERMA BED ELECTRIC - 3 SECTION

Technical Specification

- 1) NUMBER OF INDIVIDUALLY ADJUSTABLE ACTUATORS: 4
- 2) SEAT: VARIABLE FROM 51CMS TO 70 CMS & TILTED FROM 0 DEGREES TO 20 DEGREES
- 3) SIZE OF UPHOLSTERY FOR CHAIR: 165CMS (L)*54CMS (W)*7.5CMS (T)
- 4) INDIVIDUAL LOCKABLE CASTOR WHEELS: 4*7.5CMS DIAMETER
- 5) WEIGHT OF THE CHAIR: APPROX 75 KGS
- 6) WEIGHT LIFTING CAPACITY: 150 KGS
- 11) BUTTON REMOTE FUNCTION: 12 BUTTONS
- 12) ANTI-SLIP ARM REST WITH SWIVABLE POSITIONING.
 - A) BACK POSITION: UP/DOWN B) LEG POSITION: UP/DOWN
 - C) SEAT-TILT: UP/DOWN D) HEIGHT VARIABLE: UP /DOWN

FEATURES:
INDIVIDUAL MOVEMENTS OF (BACKREST, SEAT-TILT, LEGREST) AND HEIGHT



DERMA BED ELECTRIC - HIGH LOW SYSTEM ONLY

Technical Specification

DB-001	
Length	: 181 cm (71.5 Inches)
Width	: 61 cm (24 Inches)
Height	: 94 cm (37 Inches)
Minimum Height	: 71 cm (27 Inches)
Head	: 16 cm (6.25 Inches)
Motor	: 150 mm
Capacity	: 950 KV
Colour Options	: Pink, Black, Blue, Grey

New Edition - LED O.T. LIGHT



Technical Specification

Led Hexa - 4	
Dome Size	: 700mm
Intensity Lux	: 160000 +/- 10%
Colour Temp	: 4300k-4800k
Light Spot(mm) (Adjustable)	: 100mm or more
Main Supply	: Ac 220V/50 Hz
Colour Index (Ra)	: >90
Electricity Saving	: 50 to 60%
Led Life	: 50000 Hrs.
Dimming Range	: 10% to 100%

DERMA BED FULLY ELECTRIC

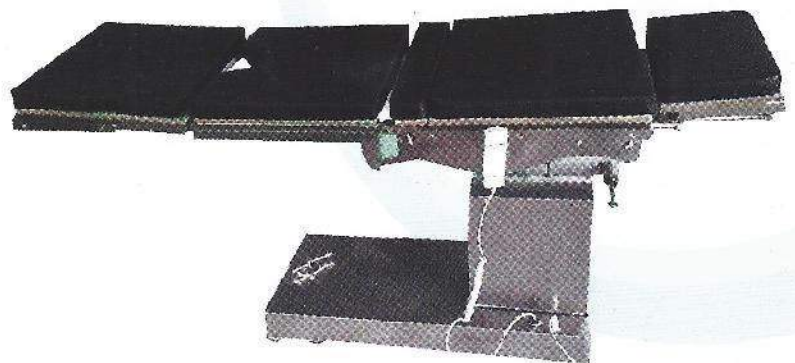

Technical Specification

Top dimension	
Height adjustment	
Trendelenburg / Reverse	: 30° / 25°
Lateral tilt	: 20° / 20°
Kidney elevator	: 130 mm
Back Rest (up / down)	: 80° / 25°
Leg Rest (up / down)	: 15° / 90°
Head Rest (up /)down	: 20° / 60°
Power supply	: 24V DC
Battery Backup	: 2 - 3 hours (optional)
Patient Weight Capacity	: 150 kgs
Mains voltage	: AC 220V±10% 50Hz



MAGNIFYING LAMP



F.U.E. PUNCH



HT MICRO MOTOR



BINOCULAR LOUPES

Technical Specification

- Frequency : 3.8 mgs.
 Power Output : 140 watts.
- ◆ No Need of ground contact or skin contact of antenna plate.
 - ◆ No Need of ground contact or skin contact of antenna plate.
 - ◆ Finger Switch (Optional) & foot Switch activated.
 - ◆ Four wave forms and five modalities of operations.
 - ◆ Autoclavable Hand piece and neutral plates. Cuts without exerting any pressure
 - ◆ Fine and active tungsten wire electrodes having flexible shaft that may be bent and modified to satisfy any need.
 - ◆ The electrodes do not need to be sharpened and can be easily sterilized.



RF COUTARY



OPTIMISER MAGNIFIER

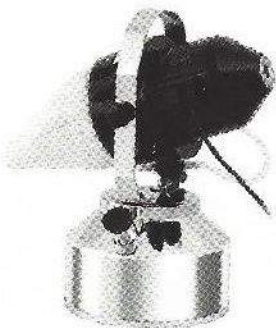

FOGGER MACHINE



DERMA BRASING BURRS



DERMOSCOPE

Dermatology Instruments & Equipments



CRASH CARD TROLLEY



SURGEON STOOL



AUTOCLAVE



MAYOS TROLLEY



INSTRUMENT TROLLEY



MEDICINE TROLLEY

Dermatology Instruments & Equipments



DERMABRASERS



MOLISCUM CURETTES

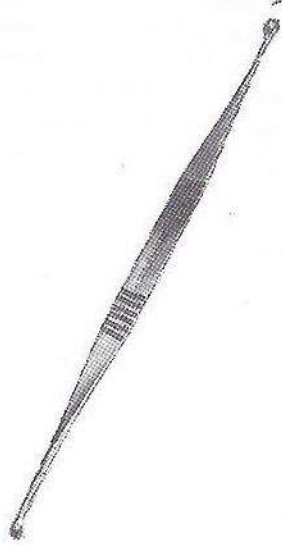

COMEDONE EXTRACTORS



ADSON FORCEPS,
SERRATED JAWS



ADSON FORCEPS,
SERRATED JAWS



ADSON FORCEPS,
ATRAUGRIP DEBEKEY



STANDARD
SERRATED FORCEPS



STANDARD TOOTH
FORCEPS



EXTRACTION
FORCEPS TITANIUM



EXTRACTION
FORCEPS SS



HT FORCEPS
CURVED



HT FORCEPS
ANGLED



HT FORCEPS
TITANIUM



HT FORCEPS
TITANIUM



HT FORCEPS
ANGLED SS



MICRO FORCEPS
STRAIGHT



DEBEKEY FORCEPS
ATRAUGRIP JAWS



Dermatology Instruments & Equipments



MOSQUITO FORCEPS
STRAIGHT / CURVED



ARTERY FORCEPS
STRAIGHT / CURVED

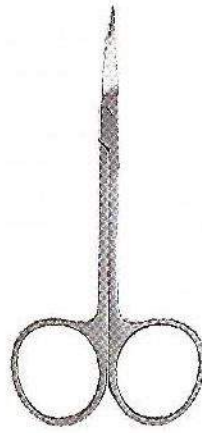

IRIS SCISSORS
STRAIGHT / CURVED



IRIS SCISSORS (TC GOLD)
STRAIGHT / CURVED



GOLDMAN FOX SCISSORS
TUNGSTEN CARBIDE
STRAIGHT / CURVED (TC GOLD)



SUPERCUT SCISSORS
TUNGSTEN CARBIDE
STRAIGHT / CURVED (TC GOLD)



TENOTOMY SCISSORS
STRAIGHT / CURVED



TISSUE SCISSORS
DOUBLE CURVED



METZENBAUM SCISSORS
TUNGSTEN CARBIDE
STRAIGHT / CURVED (TC GOLD)

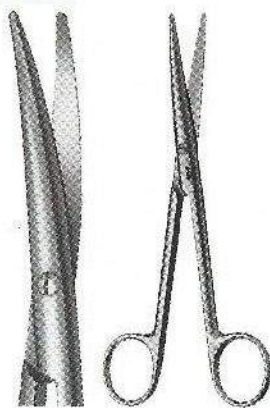

METZENBAUM SCISSORS
STRAIGHT / CURVED



HEATHS SUTURE REMOVAL
SCISSORS



ANGLED SCISSORS

Dermatology Instruments & Equipments



CASTROVIJEO NEEDLE
HOLDER STRAIGHT / CURVED
WITH LOCK



CASTROVIJEO NEEDLE
HOLDER STRAIGHT / CURVED
WITH LOCK (TC GOLD)



CASTROVIJEO NEEDLE
HOLDER STRAIGHT / CURVED
WITH LOCK (TITANIUM)



NEEDLE HOLDER WITH
SCISSORS
GILLIES (TC GOLD)

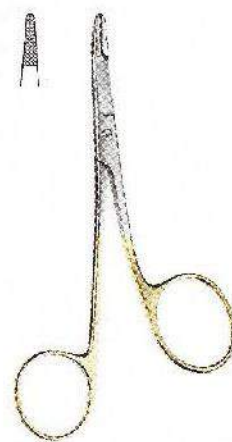

NEEDLE HOLDER WITH
SCISSORS
OLSEN HEGAR (TC GOLD)



DEBAKEY NEEDLE
HOLDER (TC GOLD)



DEBAKEY NEEDLE
HOLDER (SS)



DEBAKEY NEEDLE
HOLDER (TC GOLD)



CASTROVIJEO BLADE
BREAKER / HOLDER



CASTROVIJEO SCISSORS
STRAIGHT / CURVED



CASTROVIJEO SCISSORS
STRAIGHT / CURVED (TITANIUM)



POTTS SCISSORS
45 DEGREE



WEITLANDER
DECTACTOR

Dermatology Instruments & Equipments



**DESMARRES
RETRACTOR**



**HOWARTH
ELEVATOR**



FREERS



**NAIL SPLITER
MCDONALD**



**NAIL NIPPERS
(SS)**



**NAIL NIPPERS
(TC GOLD)**

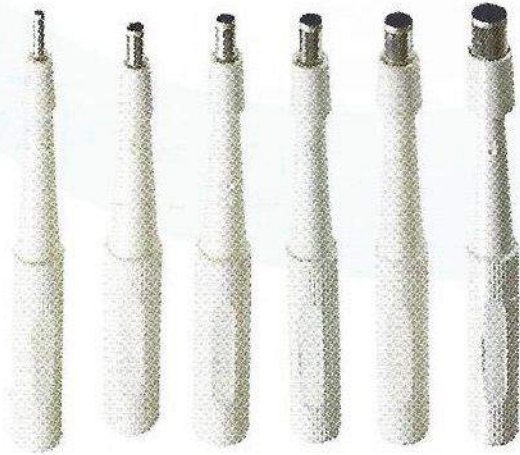

SKIN BIOPSY PUNCHES
Sizes : 1MM / 1.5MM / 2MM / 2.5MM /
3MM / 4MM / 5MM / 6MM / 7MM / 8MM



**SPRATT BONE CURETTE
WITH HANDLE OVEL**

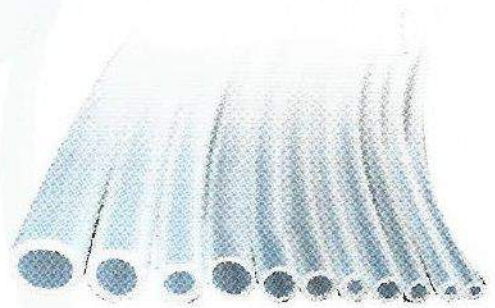

SILICON TUBE
AVAILABLE IN DIFFERENT SIZES

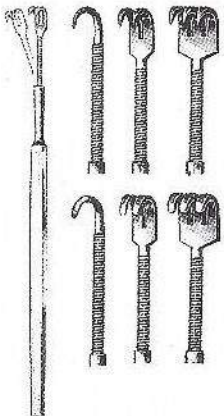

**FLEXIBLE
RETRACTORS**

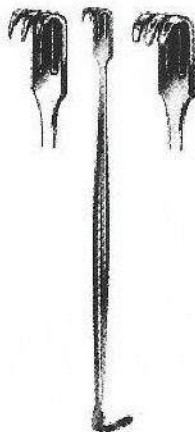

**SENN RETRACTOR
3 PRONGS**

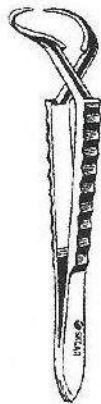

**TOWEL CLIP
CROSS ACTION**



**TOWEL
FORCEPS**



**DRESSING
DRUM**
Sizes : 9X9 / 11X9

THE MARK OF QUALITY & CRAFTSMANSHIP



**HAIR
TRANSPLANT
SURGICAL
INSTRUMENTS**

**The House Known For
Surgical Instruments**



JULLUNDUR ENTERPRISES

Manufacturer & Exporter Of Surgical Instruments





HAIR TRANSPLANT FORCEPS



FUE MOTOR



HAND PIECE FOR FUE MOTOR



FUE PUNCH



CENTRIFUGE FOR PRP

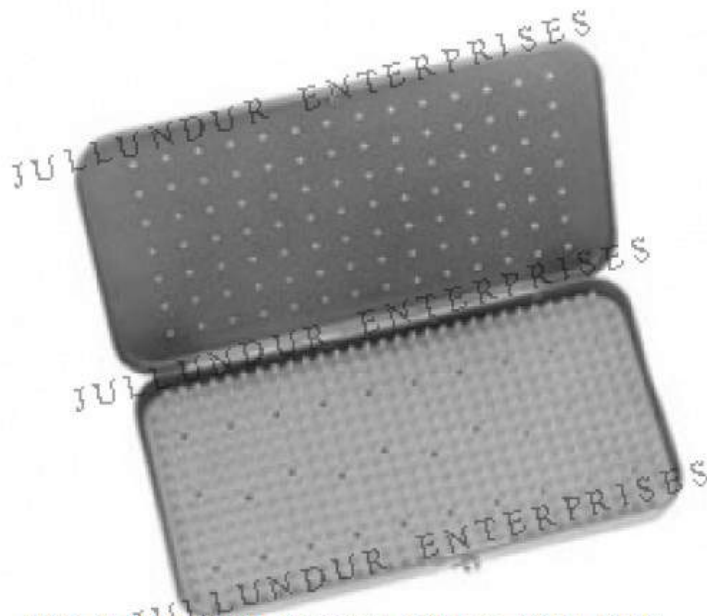

MICRO INSTRUMENTS STERILIZATION TRAY



AUTOClave

Silicon Gel Head Beds

Prone Position Head Gel Bed



Model : 1101 - 1
Size : 28 x 24 x 14 cm
Model : 1101 - 2
25 x 20 x 10 cm



Donut



Horse Shoe



LOUPE 2.5X / 3.5X / 4X / 6X



LOUPE WITH
RECHARGEABLE
LED LIGHT



FUMIGATOR 1.5L / 3L / 5L



EAR PIERCING GUN

JULLUNDUR ENTERPRISES

LAPRASCOPY INSTRUMENTS CATALOG

1568-A, G-22-23, BHAGIRATH PALACE

DELHI 110006, INDIA

Mobile : +91 9871432046 / +91 9312281439 / +91 9810660343

Email : info@jemediguard.com

Website : www.jemediguard.com

Clip Applier



Clip Applicator

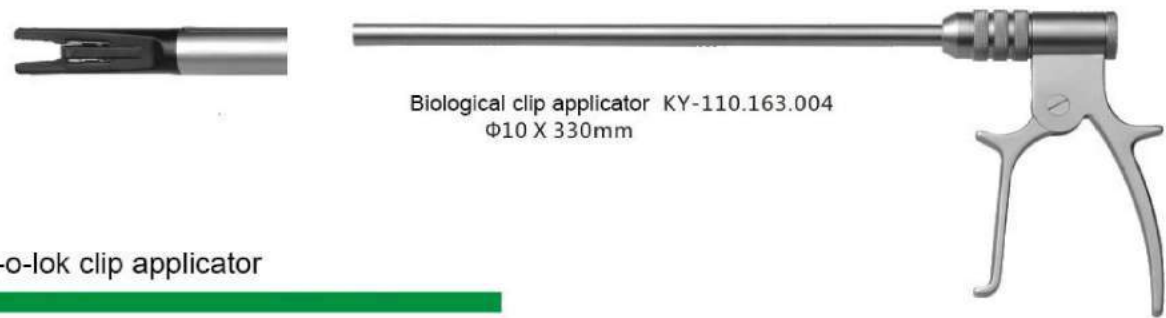

Hem-o-lok clip applicator

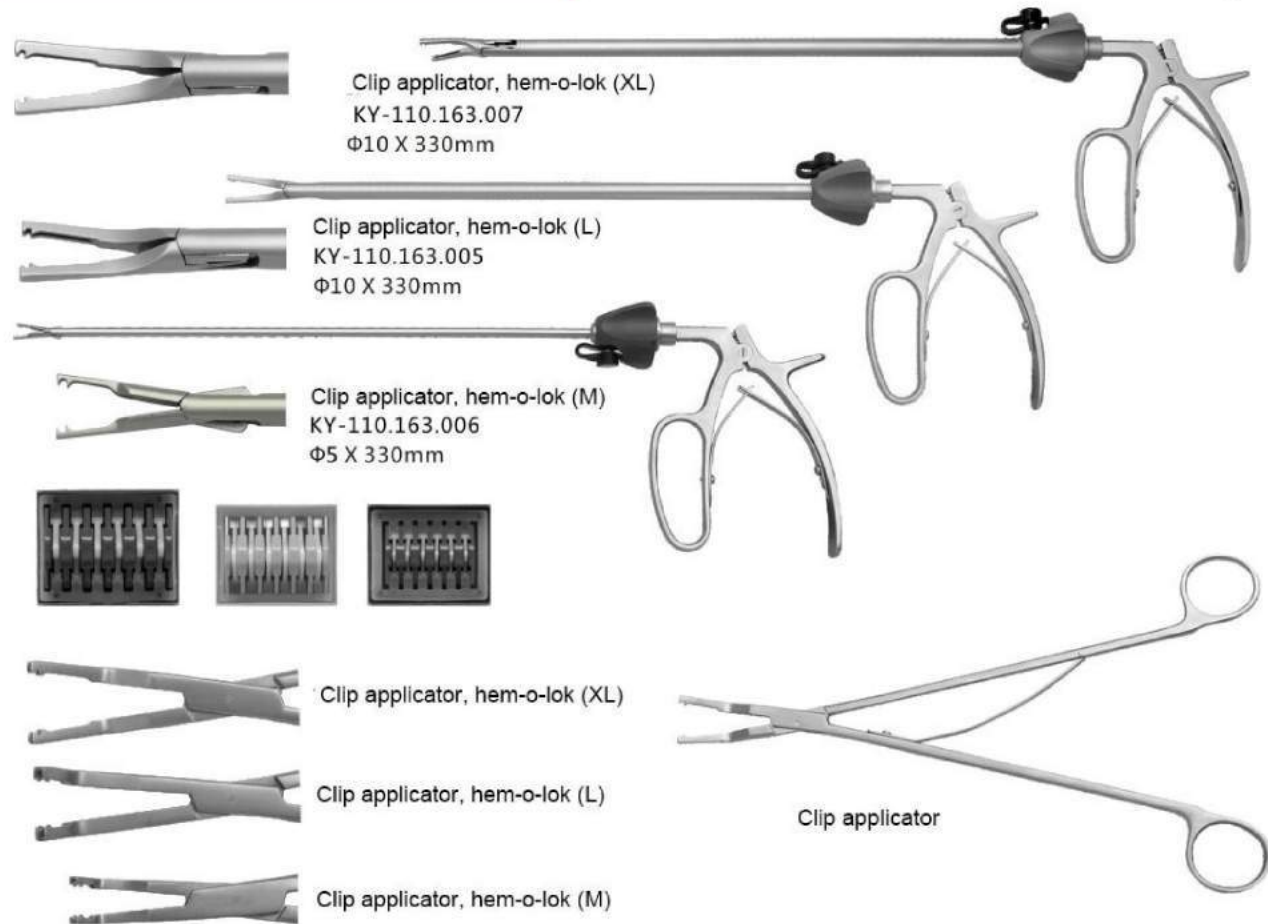

Forceps and Scissors

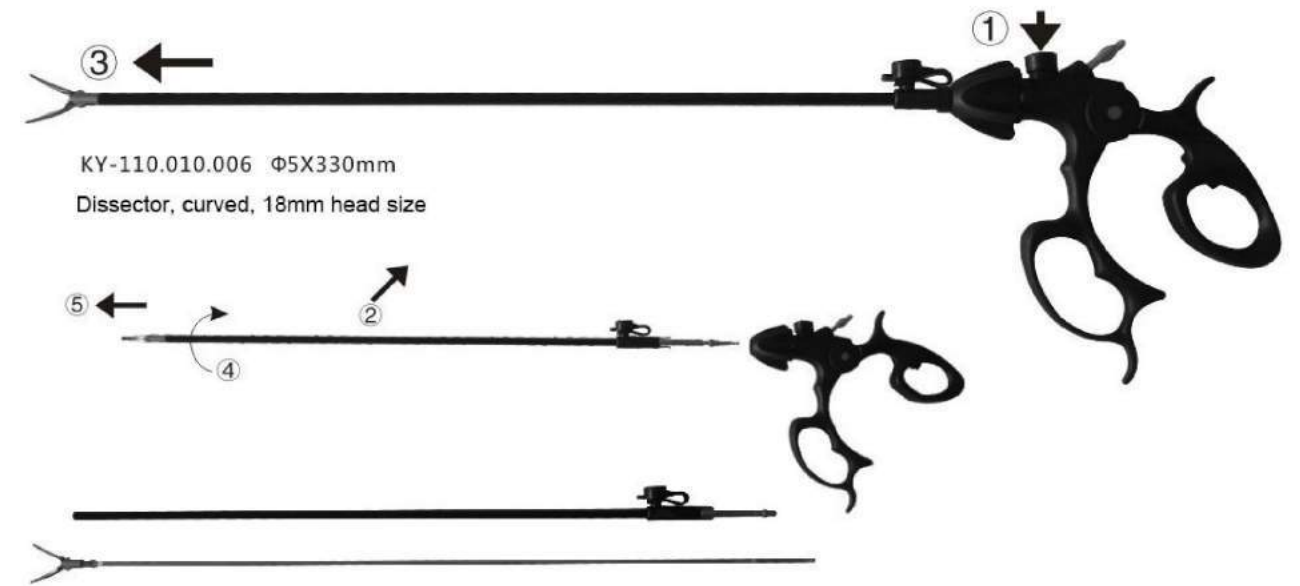
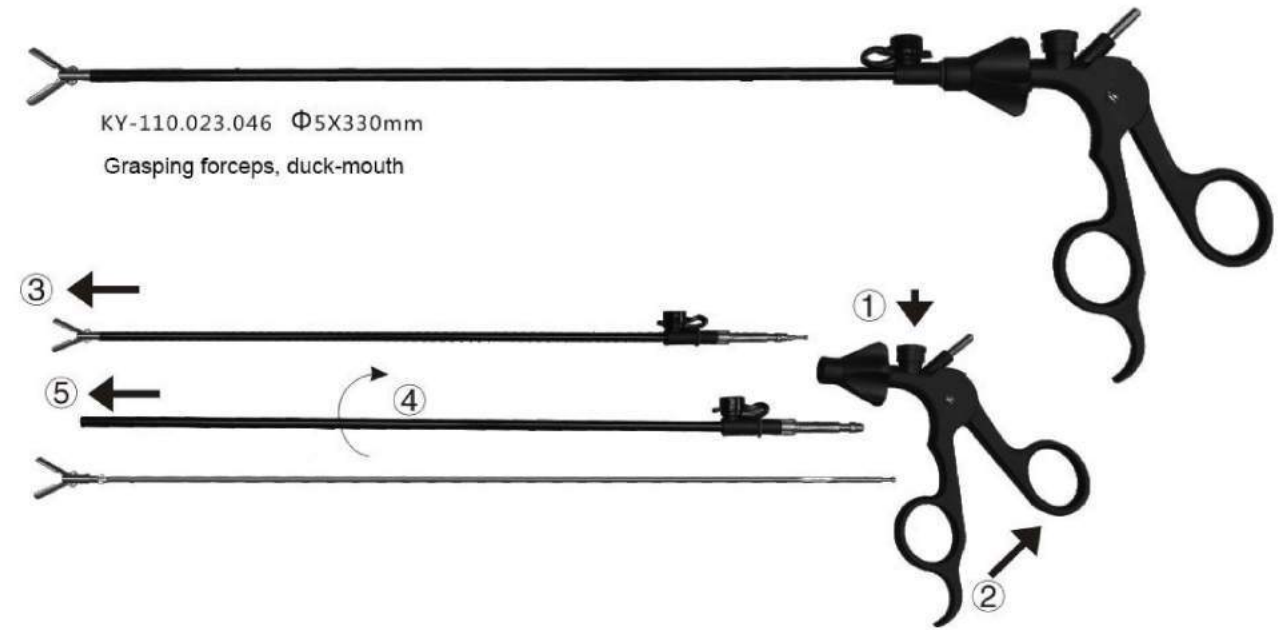

Forceps and Scissors



KY-110.010.001-3A

KY-110.010.001-3B

KY-110.010.001-3C

KY-110.010.001-3D



Scissors, straight, single action
KY-110.015.001
φ 5x330mm



Scissors, straight, double action
KY-110.015.002
φ 5x330mm



Scissors, curved, single action
KY-110.015.003
φ 5x330mm



Scissors, curved, double action
KY-110.015.004
φ 5x330mm



Mini scissors
KY-110.015.005
φ 5x330mm



Hook scissors
KY-110.015.006
φ 5x330mm



Sharp scissors
KY-110.015.007
φ 5x330mm



Dissector, straight
KY-110.010.001
φ 5x330mm



Dissector, curved, 17mm head size
KY-110.010.002
φ 5x330mm



Dissector, curved, 12mm head size
KY-110.010.003
φ 5x330mm



Dissector, curved, 14mm head size
KY-110.010.004
φ 5x330mm



Dissector, curved, 18mm head size
KY-110.010.006
φ 5x330mm



Dissector, curved, 20mm head size
KY-110.010.007
φ 5x330mm



Dissector, curved, 25mm head size
KY-110.010.008
φ 5x330mm



Dissector, blunt, curved, 16mm head size
KY-110.010.009
φ 5x330mm



Dissector, curved, net tooth
KY-110.010.010
φ 5x330mm



Right angle dissector A
KY-110.010.011
φ 5x330mm



Right angle dissector B
KY-110.010.012
φ 5x330mm



Grasping forceps, pointed head
KY-110.023.019
φ 5x330mm



Biopsy forceps with needle
KY-110.023.021
φ 5x330mm



Biopsy forceps
KY-110.023.020
φ 5x330mm



Grasping forceps, blunt
KY-110.023.018
φ 5x330mm



Oviduct grasping forceps A
KY-110.023.027
φ 5x330mm



Oviduct grasping forceps B
KY-110.023.028
φ 5x330mm



Rat tooth grasping forceps, 2+3 teeth
double action
KY-110.023.025
φ 5x330mm



Rat tooth grasping forceps, 2+4 teeth
single action
KY-110.023.022
φ 5x330mm



Rat tooth grasping forceps, 2+4 teeth
double action
KY-110.023.023
φ 5x330mm



KY-110.023.040
φ 5x330mm



Knot forceps
KY-110.111.001
φ 5x330mm



Knot forceps, S type
KY-110.111.003
φ 5x330mm



Knot forceps, B type
KY-110.112.002
φ 5x330mm



Stomach grasping forceps, single action
KY-110.023.038
φ 5x330mm



Stomach grasping forceps
KY-110.023.037
φ 5x330mm



O-shaped grasping forceps
KY-110.023.039
φ 5x330mm



V-shaped grasping forceps (A)
KY-110.023.033
φ 5x330mm



V-shaped grasping forceps (B)
KY-110.023.034
φ 5x330mm



Grasping forceps
KY-110.023.029
φ 5x330mm



Grasping forceps
KY-110.023.030
φ 5x330mm



Atraumatic grasping forceps (B)
KY-110.023.004
φ 5x330mm



Atraumatic grasping forceps (A)
KY-110.023.003
φ 5x330mm

Forceps and Scissors



Forceps and Scissors

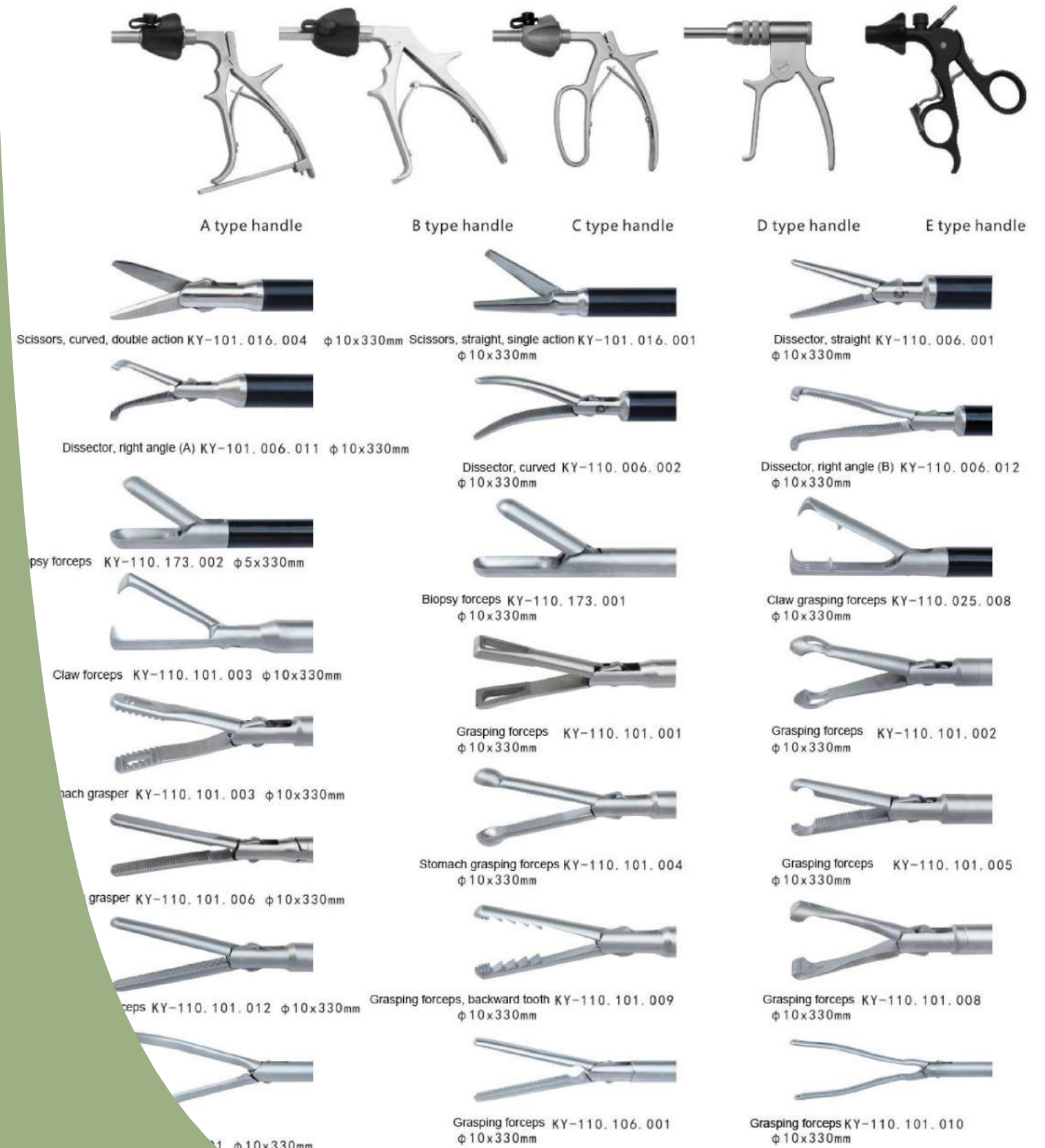

Trocar



Trocar, magnetism
KY-110.152.005 Φ5×115mm



Trocar, magnetism
KY-110.154.005 Φ10×120mm



Trocar, cross
KY-110.152.001 Φ5×115mm



Trocar, cross
KY-110.154.001 Φ10×120mm

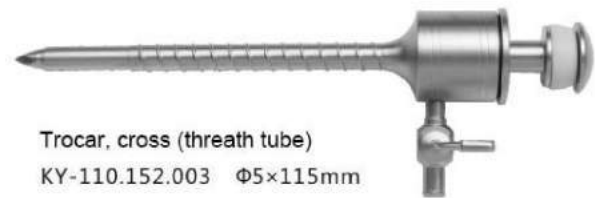

Trocar, cross (thread tube)
KY-110.152.003 Φ5×115mm



Trocar, cross (thread tube)
KY-110.154.003 Φ10×120mm



Trocar, magnetism
KY-110.155.005 Φ12×120mm

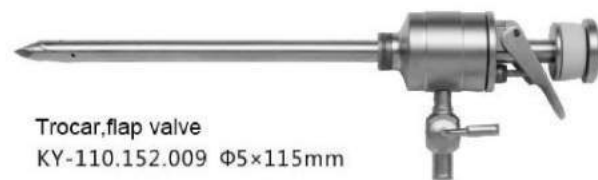

Trocar, flap valve
KY-110.152.009 Φ5×115mm



Trocar, cross
KY-110.155.001 Φ12×120mm



Trocar, flap valve
KY-110.154.009 Φ10×120mm



Trocar, cross (thread tube)
KY-110.155.003 Φ12×120mm



Safety trocar

Trocar
KY-311.016 Φ12mm

Trocar
KY-311.017 Φ10mm

Trocar
KY-311.018 Φ5mm

Reducer
KY-210.033.001
Φ10-Φ5mm



Sealing cap (cross)
Φ3mm
Φ5mm
Φ10.5mm



Sealing cap
Φ3mm
Φ5mm
Φ10.5mm



Sealing ring
Φ5mm
Φ10.5mm

Bipolar Forceps



Bipolar forceps Φ5 X 330mm

KY-110.036.012
Atraumatic type

KY-110.036.011
Maryland type

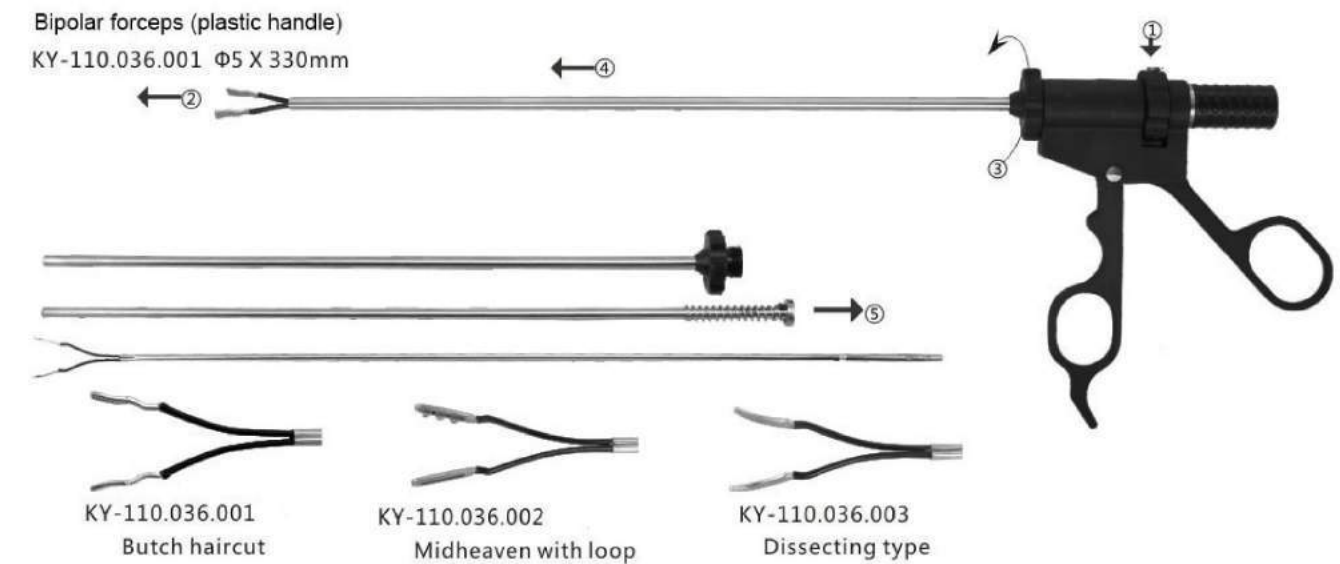

Bipolar forceps (plastic handle)
KY-110.036.001 Φ5 X 330mm

KY-110.036.001
Butch haircut

KY-110.036.002
Midheaven with loop

KY-110.036.003
Dissecting type



Bipolar forceps (metal handle)
KY-110.036.006 Φ5 X 330mm

KY-110.036.011
3000mm

Electric instruments

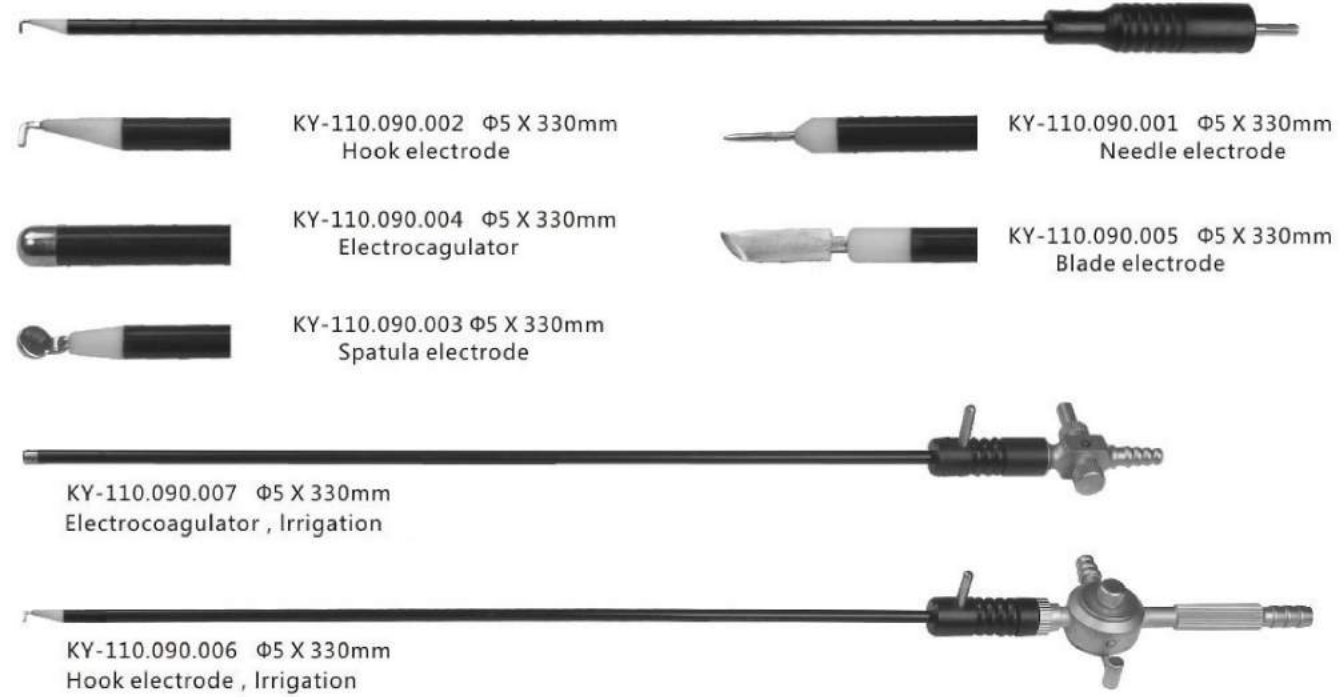

Suction&Irrigation Tube

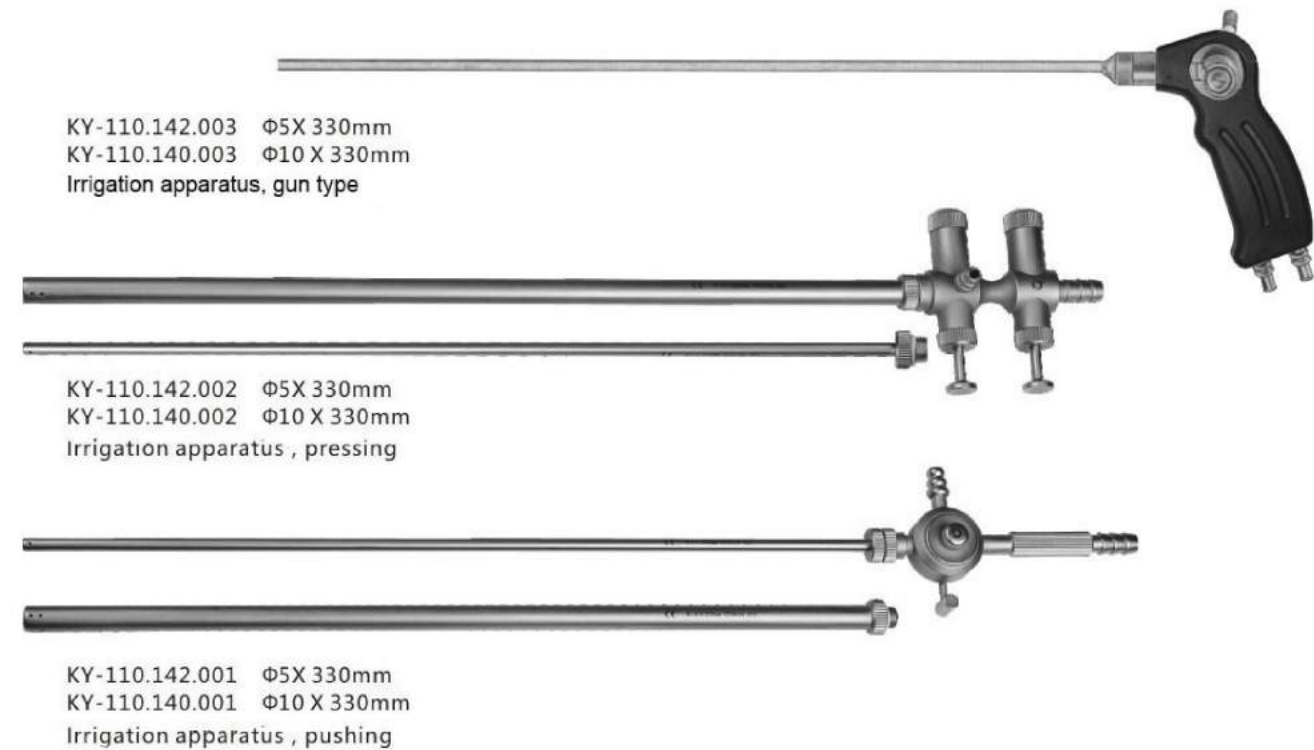

Needle holding forceps

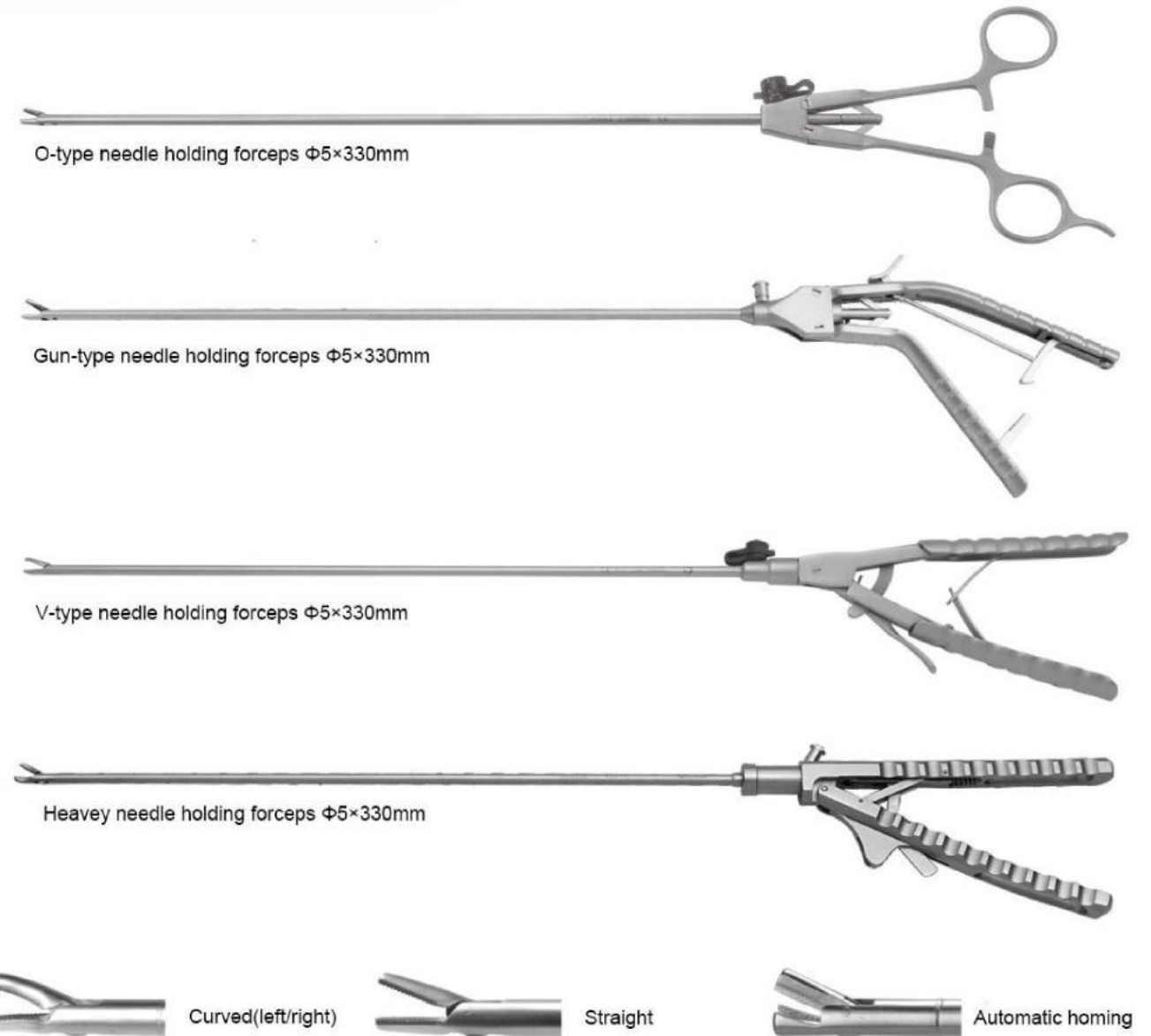

Needle

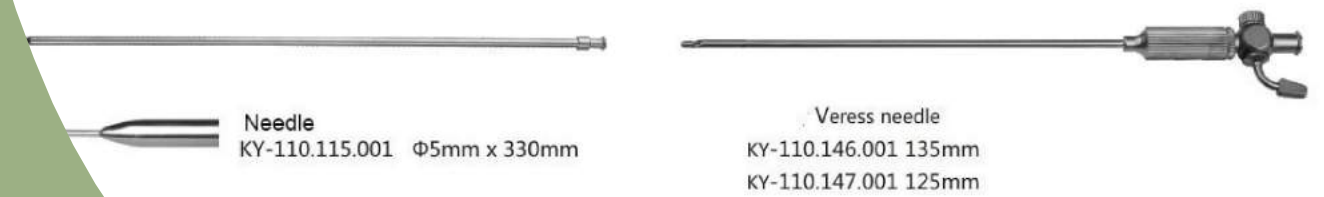

Bile Duct Knife

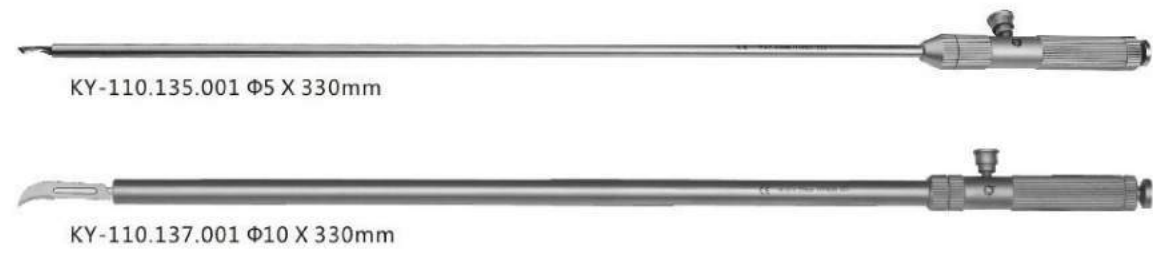

KY-110.135.001 $\Phi 5 \times 330\text{mm}$

KY-110.137.001 $\Phi 10 \times 330\text{mm}$

Cholangiograph Forceps



Cholangiograph forceps
KY-110.103.003 $\Phi 5\text{mm} \times 330\text{mm}$

Spring Grasping Forceps



Spring grasping forceps
KY-110.103.002 $\Phi 5\text{mm} \times 330\text{mm}$

Spring grasping forceps
KY-110.103.001 $\Phi 5\text{mm} \times 330\text{mm}$

Fan Retractor

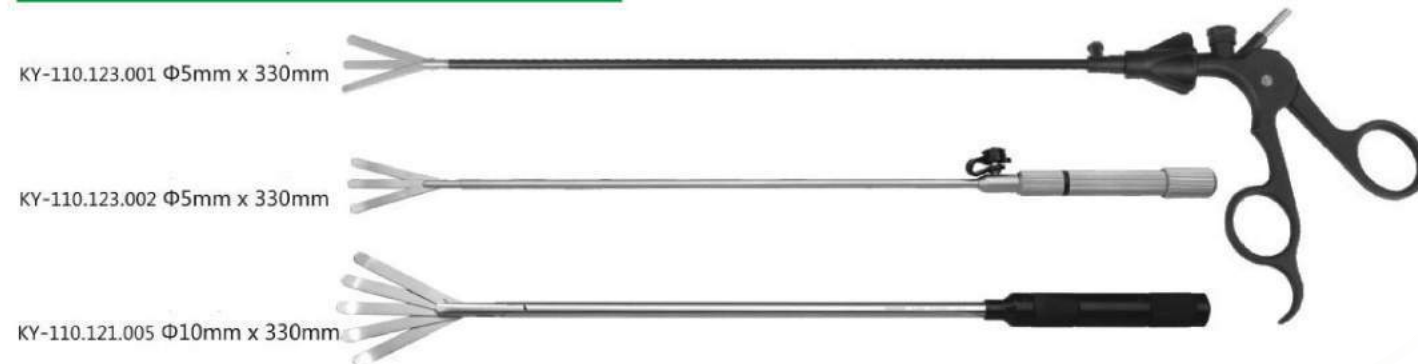

KY-110.123.001 $\Phi 5\text{mm} \times 330\text{mm}$

KY-110.123.002 $\Phi 5\text{mm} \times 330\text{mm}$

KY-110.121.005 $\Phi 10\text{mm} \times 330\text{mm}$

Bile Duct Forcep

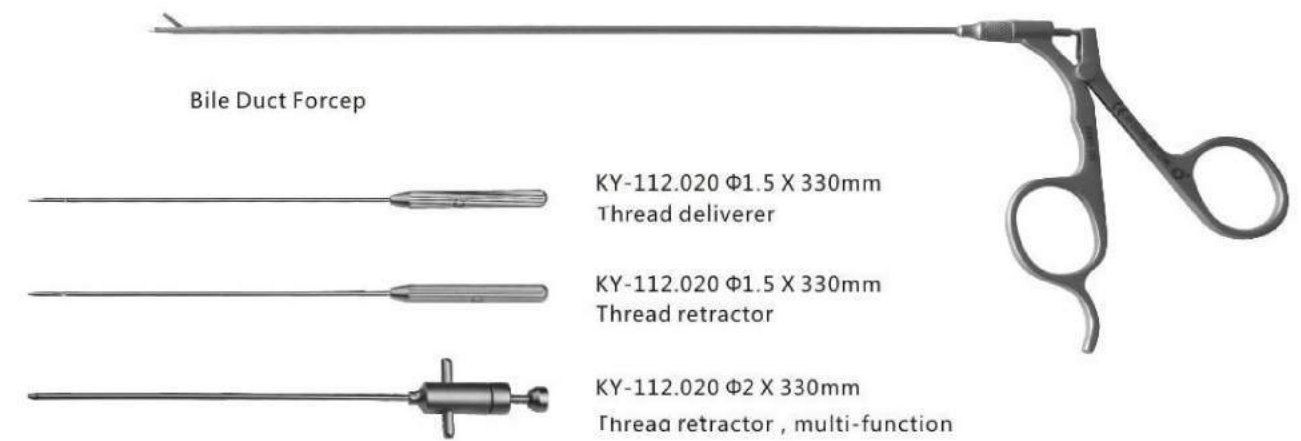

Bile Duct Forcep

KY-112.020 $\Phi 1.5 \times 330\text{mm}$
Thread deliverer

KY-112.020 $\Phi 1.5 \times 330\text{mm}$
Thread retractor

KY-112.020 $\Phi 2 \times 330\text{mm}$
Thread retractor, multi-function

Bulldog Forceps

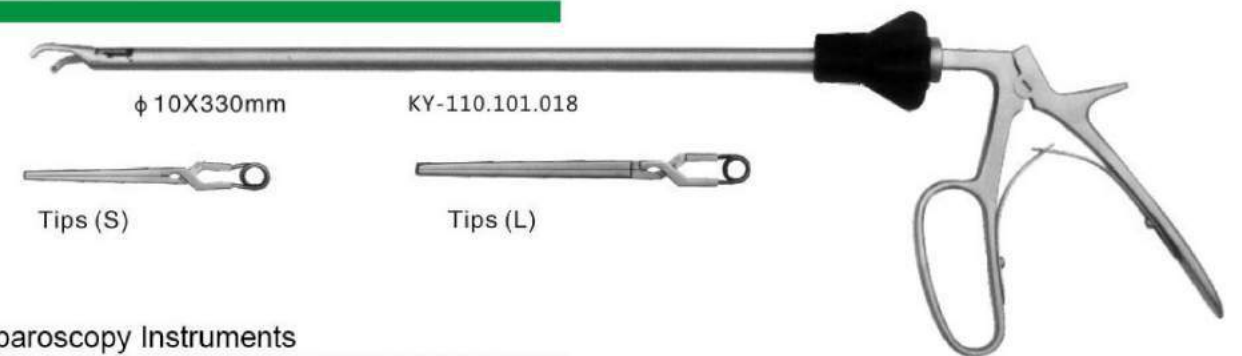

$\phi 10 \times 330\text{mm}$

KY-110.101.018

Tips (S)

Tips (L)

Laparoscopy Instruments

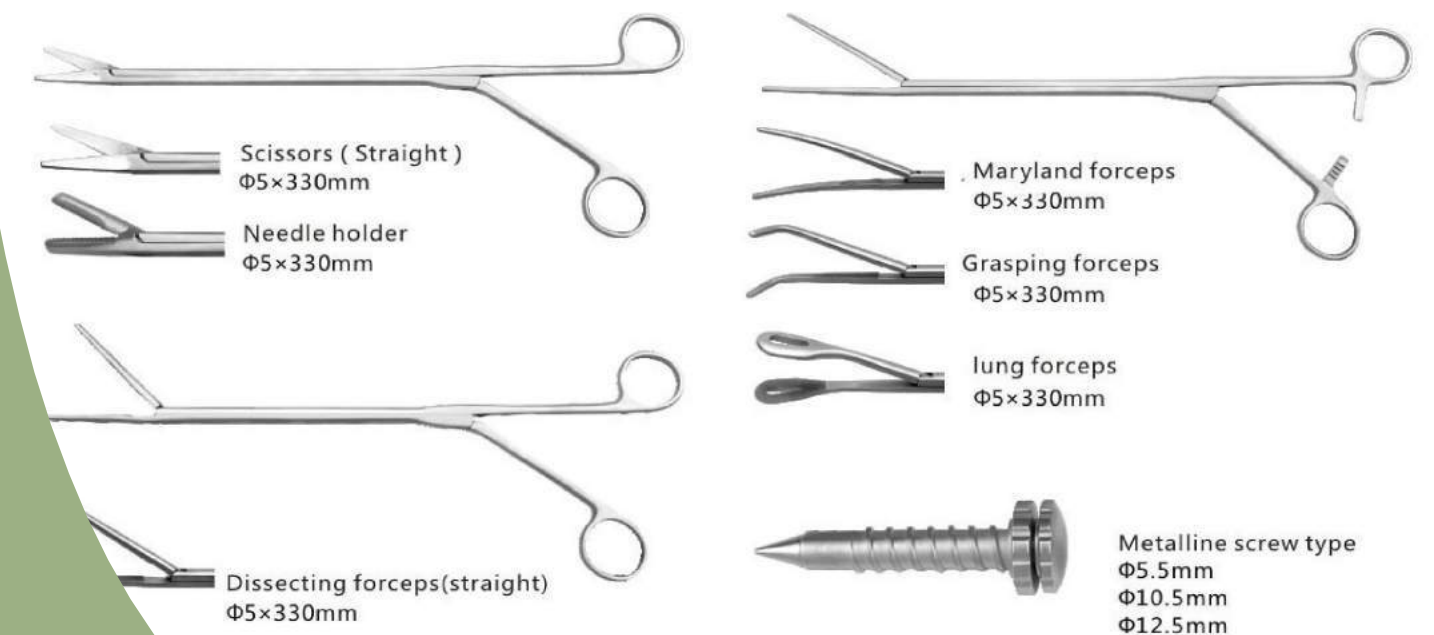

Scissors (Straight)
 $\Phi 5 \times 330\text{mm}$

Needle holder
 $\Phi 5 \times 330\text{mm}$

Maryland forceps
 $\Phi 5 \times 330\text{mm}$

Grasping forceps
 $\Phi 5 \times 330\text{mm}$

lung forceps
 $\Phi 5 \times 330\text{mm}$

Dissecting forceps(straight)
 $\Phi 5 \times 330\text{mm}$

Metalline screw type
 $\Phi 5.5\text{mm}$
 $\Phi 10.5\text{mm}$
 $\Phi 12.5\text{mm}$

Mini-instruments for laparoscopy



Single port instruments

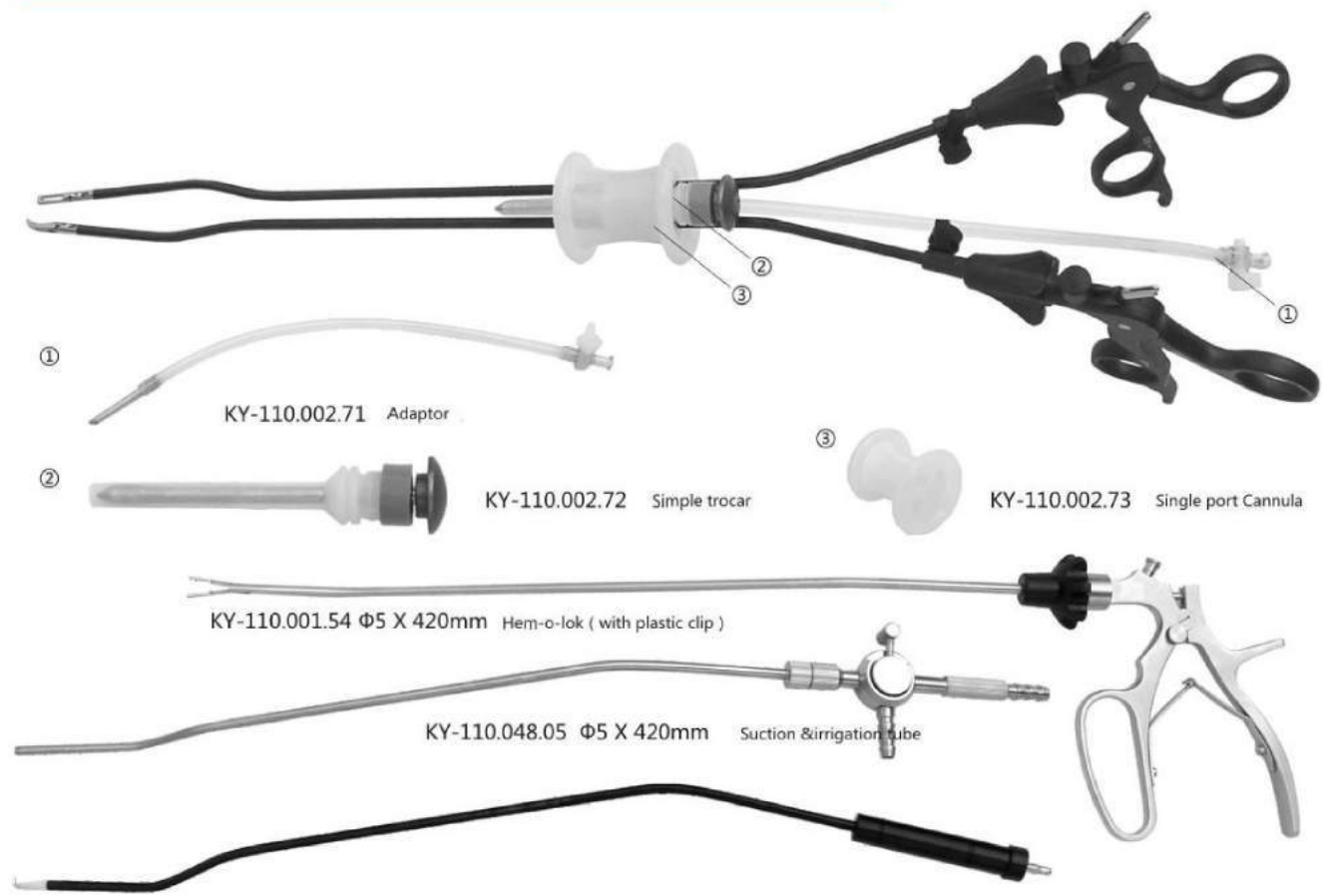

Mention led device for insufflation free surgery

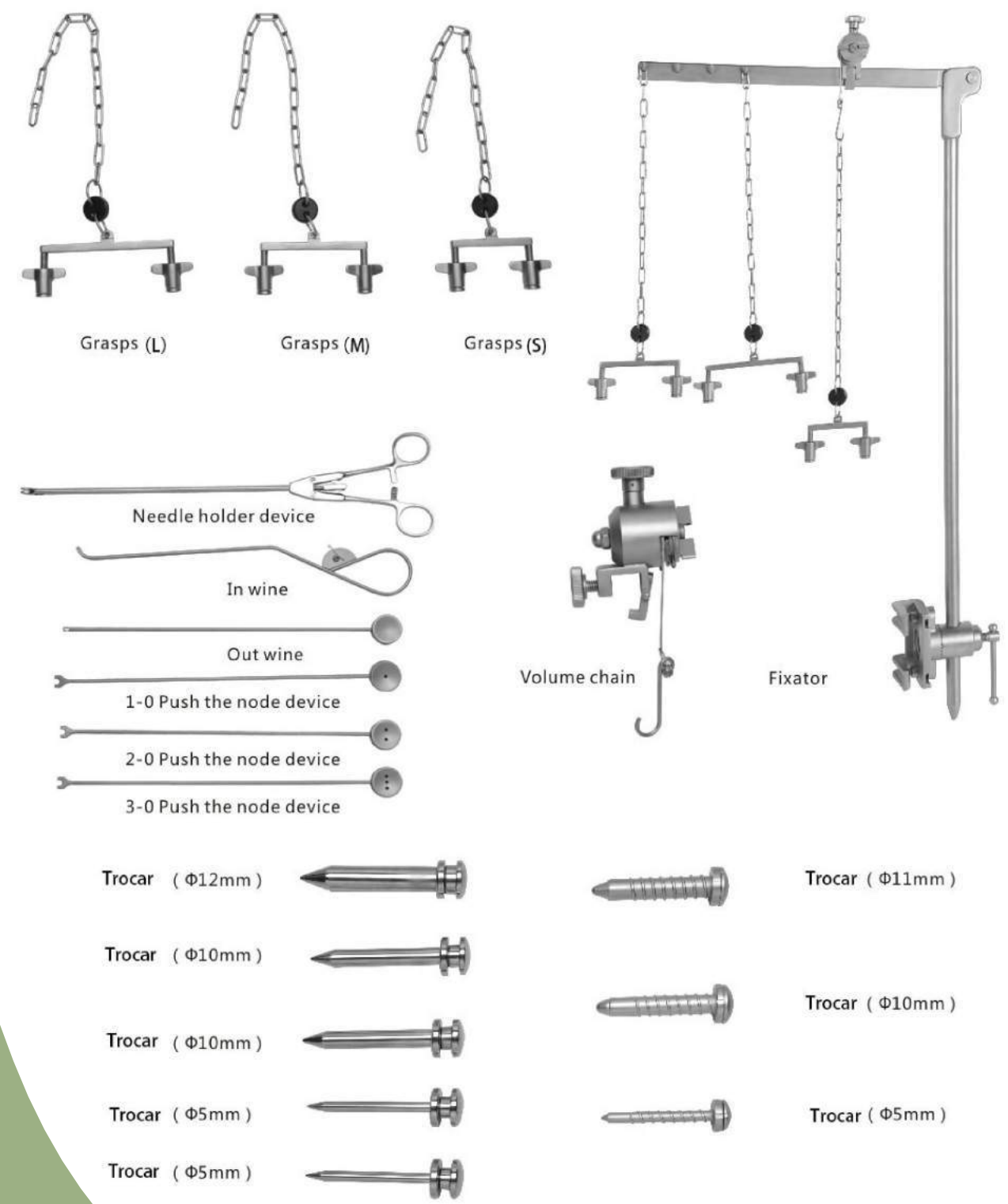

Instruments for Hysterectomy surgery

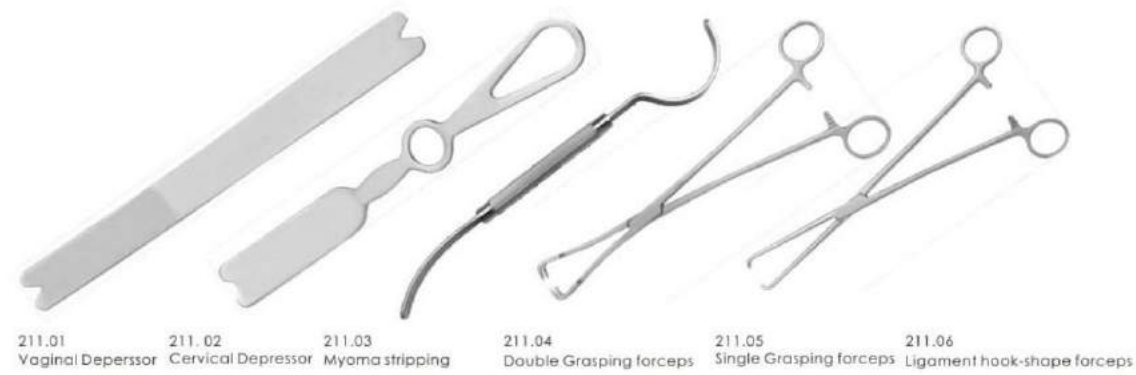

Instruments for Hysterectomy surgery

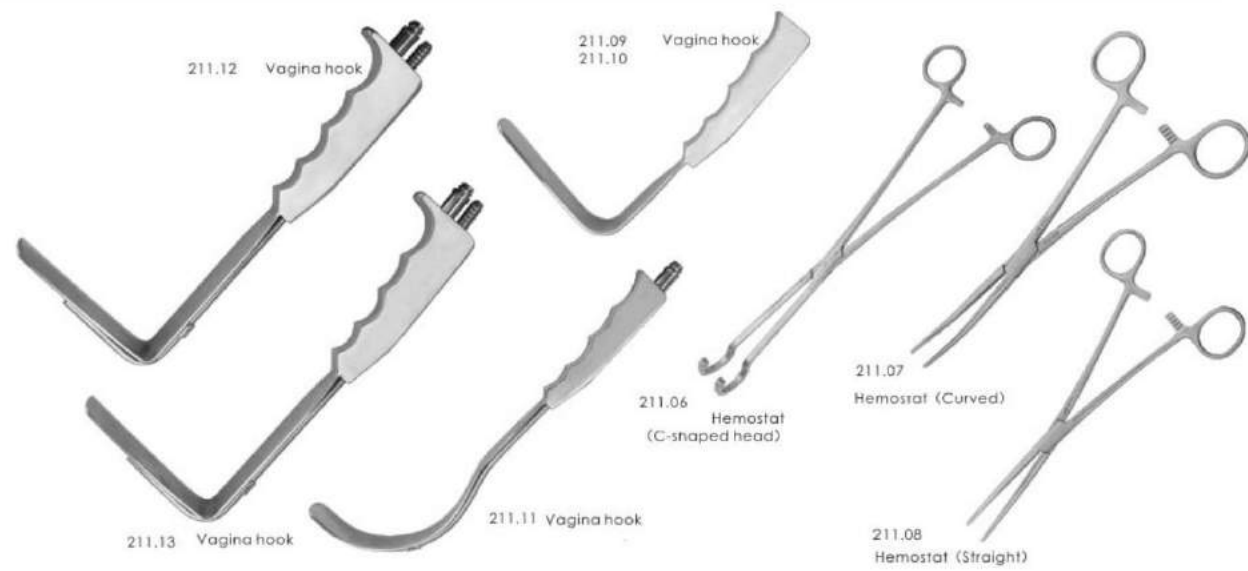

Instruments for Hysterectomy surgery



Apparatus-A KY-210.014.002



Apparatus-B KY-210.014.003



Uterus-lifting apparatus KY-210.014.004

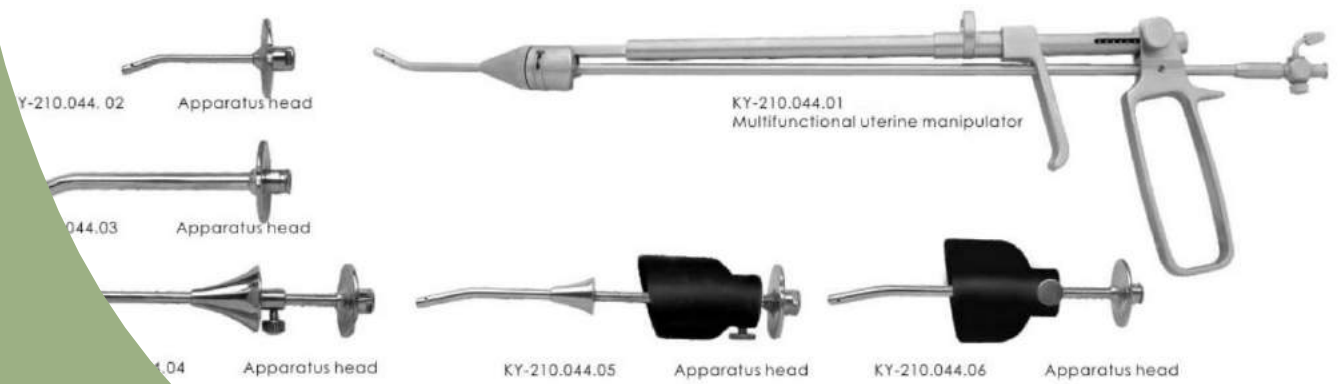

Electric Uterus-cutter



KY-210.011 Control unit

Cutting tube(TAH)
 KY-210.021.001 Φ 10mm X 320mm KY-210.020.001 Φ 15mm X 320mm
 KY-210.019.001 Φ 18mm X 320mm

Cutting tube(LAVH)
 KY-210.023.002 Φ 15mm X 320mm KY-210.022.002 Φ 18mm X 320mm

Moving bar
 KY-210.017.001 Φ 5mm X 420mm

Hysteromyoma drill
 KY-210.016.001 Φ 5mm X 420mm KY-210.015.001 Φ 10mm X 420mm

Uterus measuring stick
 KY-210.018.001 Φ 5mm X 500mm

Knot-pushing stick
 KY-210.032.001 Φ 5mm X 330mm

Guide probe
 KY-210.031.001 Φ 10mm X 330mm

Grasping forceps
 KY-210.012.001 Φ 10mm X 420mm
 KY-210.013.001 Φ 5mm X 420mm

Handle wheel

Uterine manipultor
 KY-210.014 400mm

Trocar sleeve
 KY-210.030.001 Φ 15mm X 95mm
 KY-210.029.001 Φ 18mm X 95mm

Dilator
 KY-210.025.001 Φ 10mm/ Φ 15mm
 KY-210.024.001 Φ 10mm/ Φ 18mm

Reducer
 KY-210.027.001 Φ 15mm- Φ 5mm
 KY-210.026.001 Φ 18mm- Φ 5mm

Cervical forceps
 KY-210.028.002 250mm

Cervical forceps
 KY-210.028.001 250mm

Import drive Motor
 KY-210.010

Electric Uterus-cutter

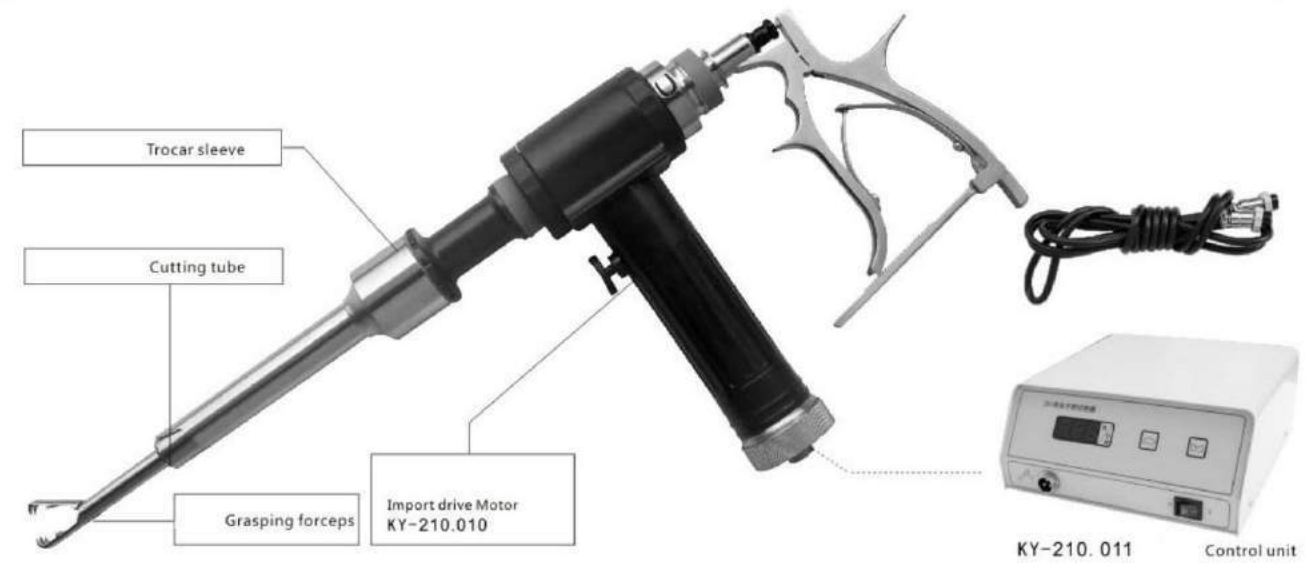

KY-210.011 Control unit

Cutting tube
 KY-210.021 Φ 18mm \times 278mm KY-210.020 Φ 15mm \times 278mm
 KY-210.019 Φ 10mm \times 278mm

Reducer
 KY-210.020.1 Φ 15mm-10mm KY-210.021.1 Φ 18mm-10mm
 KY-210.019.1 Φ 10mm-5mm

Grasping forceps
 KY-210.012.001 Φ 10mm X 420mm
 KY-210.013.001 Φ 5mm X 420mm

Moving bar
 KY-210.017 Φ 5mm X 420mm

Guide probe
 KY-210.031 Φ 10mm X 330mm

Knot-pushing stick
 KY-210.032 Φ 5mm X 330mm

Uterine manipultor
 KY-210.014.1 400mm

Hysteromyoma drill
 KY-210.016.002 Φ 5mm X 420mm
 KY-210.015.002 Φ 10mm X 420mm

Trocar sleeve
 KY-210.029.002 Φ 18mm X 102mm
 KY-210.030.002 Φ 15mm X 102mm

Dilator
 KY-210.025 Φ 10mm/ Φ 15mm
 KY-210.024 Φ 10mm/ Φ 18mm

Reducer
 KY-210.027 Φ 15mm- Φ 5mm
 KY-210.026 Φ 18mm- Φ 5mm

Cervical forceps
 KY-210.028.001 250mm

Cervical forceps
 KY-210.028.002 250mm

Import drive Motor
 KY-210.010

Cysto-Urethroscope

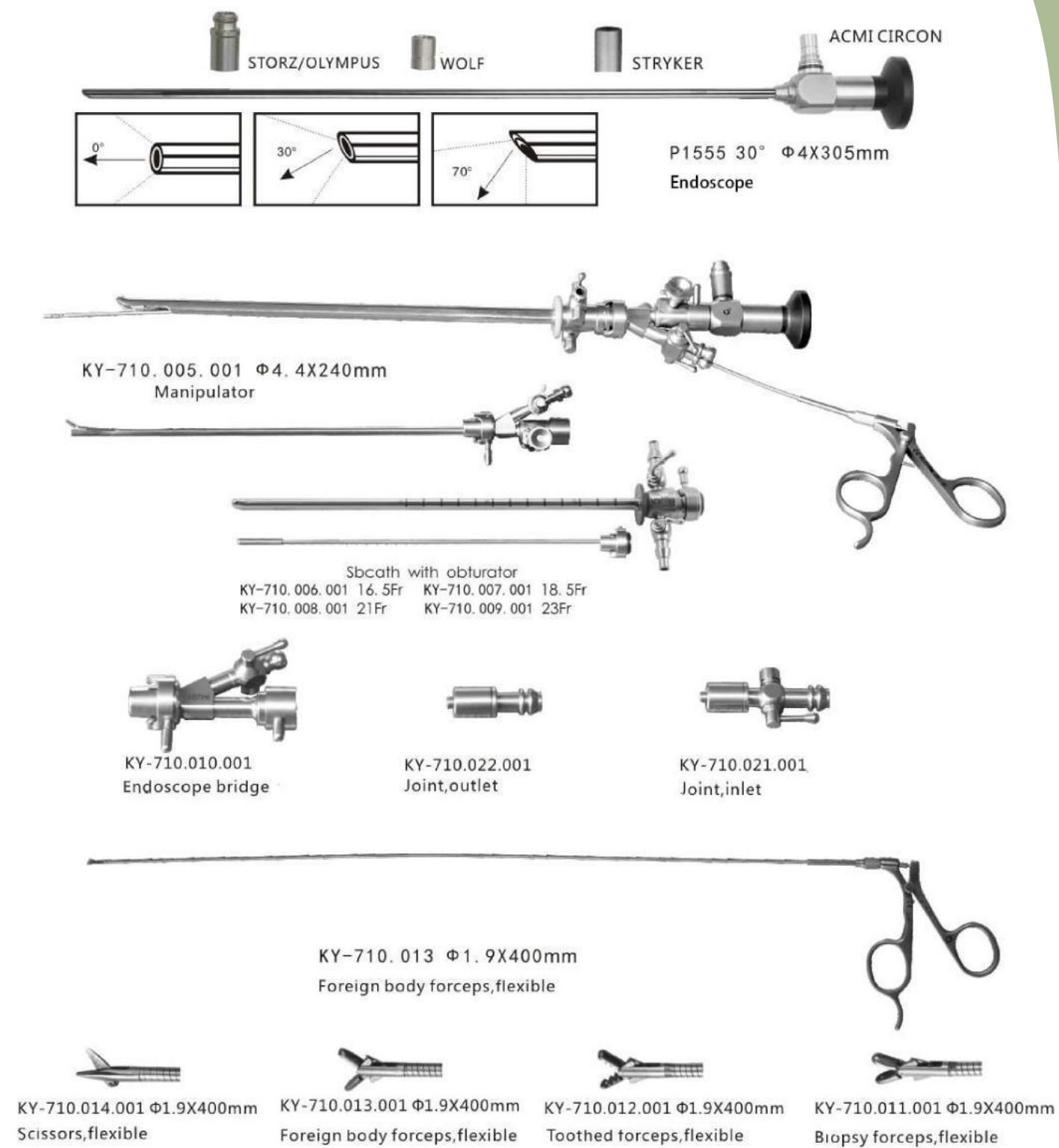

Lithotripsy

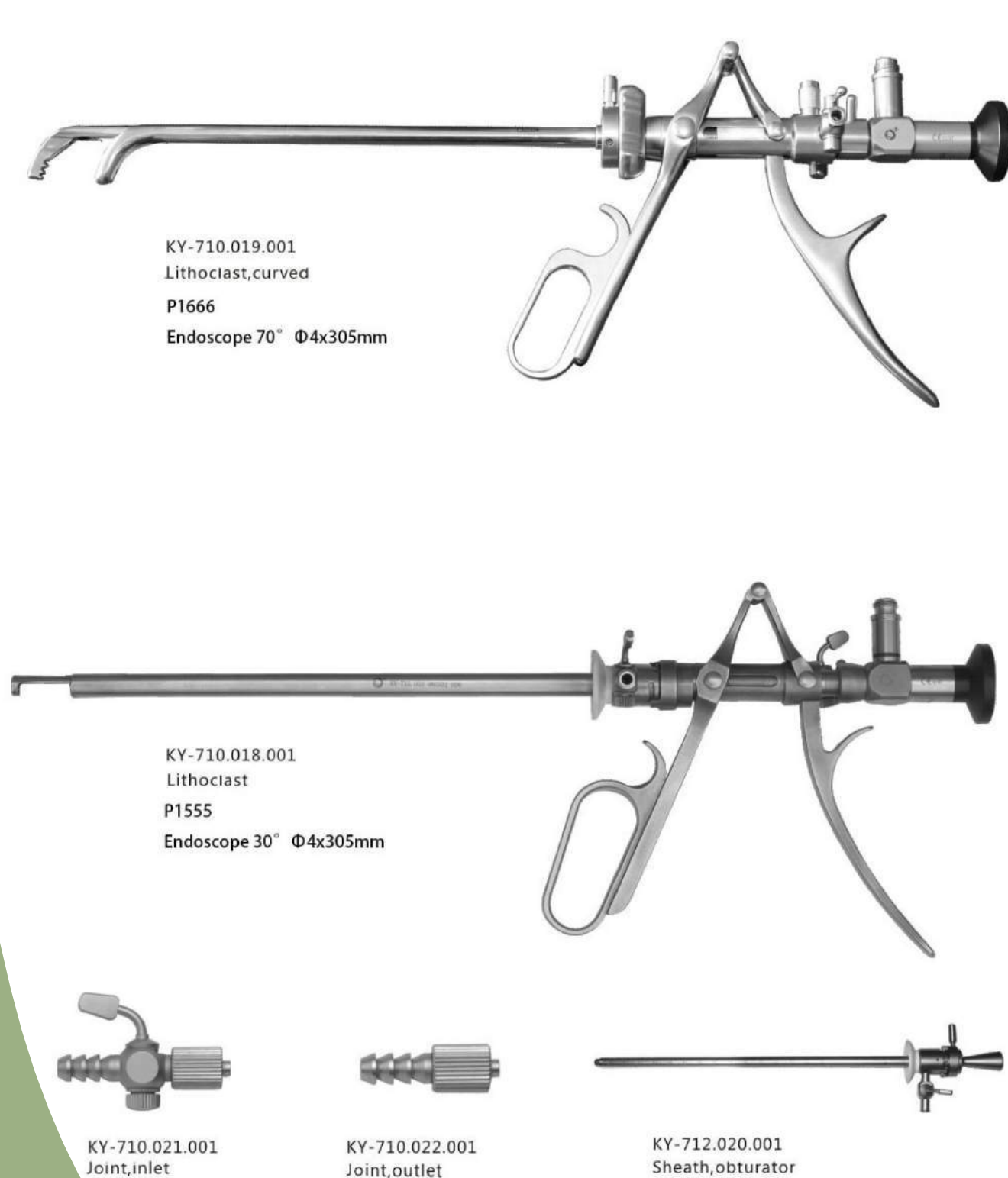

Bipolar resectoscope



KY-716
Bipolar resectoscope

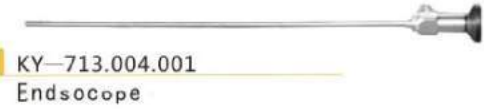

KY-713.004.001
Endoscope



KY-713.113.001
Needle loop



KY-713.106.001 Fr26.5
Outer sheath



KY-214.009 Joint, inlet
KY-214.010 Joint, outlet
KY-713.105.001 active
KY-713.110.001 passive



KY-713.107.001 Fr22.5
Inner sheath



KY-713.108.001
Visual sheath



KY-713.007.1 Irrigation connector
KY-713.007.2 Evacuator



KY-713.109.001
Obturator

Monopolar resectoscope

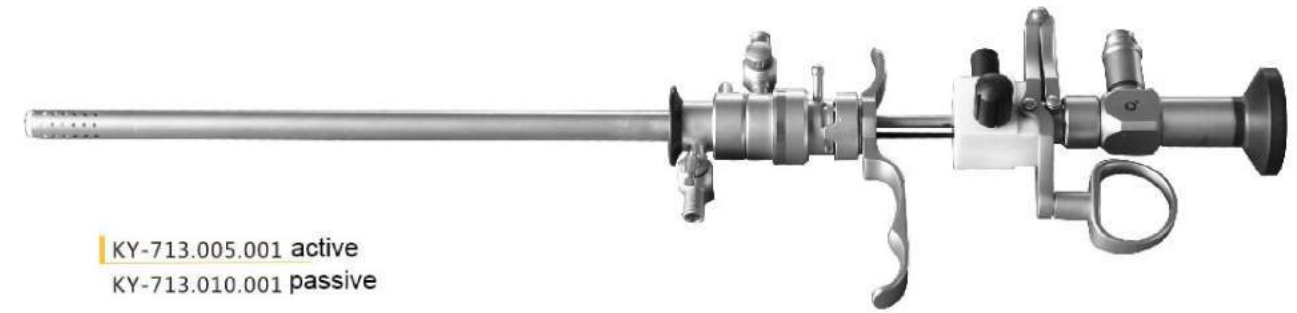

KY-713.005.001 active
KY-713.010.001 passive



KY-713.011.001
Cutting loop



KY-713.013.001
Spike electrode



KY-713.014.001
Vaporisation electrode, roller



KY-713.017.001
Myoma-cutting loop



KY-713.015.001
Vaporisation electrode, spud



KY-713.006.001 Fr 26.5
Outer sheath



KY-713.007
Evacuator



KY-713.006.001 Fr 22.5
Inner sheath, obturator



KY-713.009.001
Sheath obturator



KY-214.009 Joint, inlet
KY-214.010 Joint, outlet

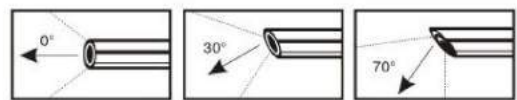

KY-121 30° ϕ 4x175 / ϕ 2.7x175mm
Endoscope

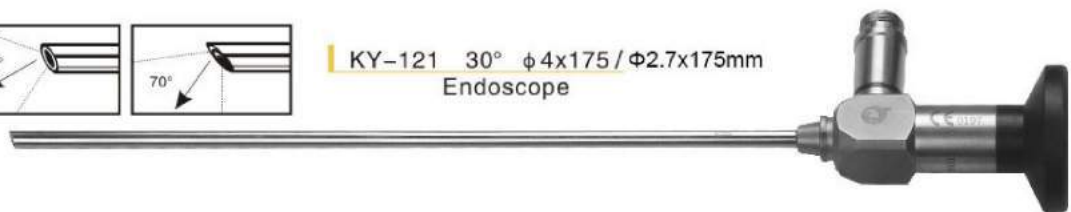

YSG-D-1
Surgical cutter, with suction



KY-410.022.001 0°
Optical forceps

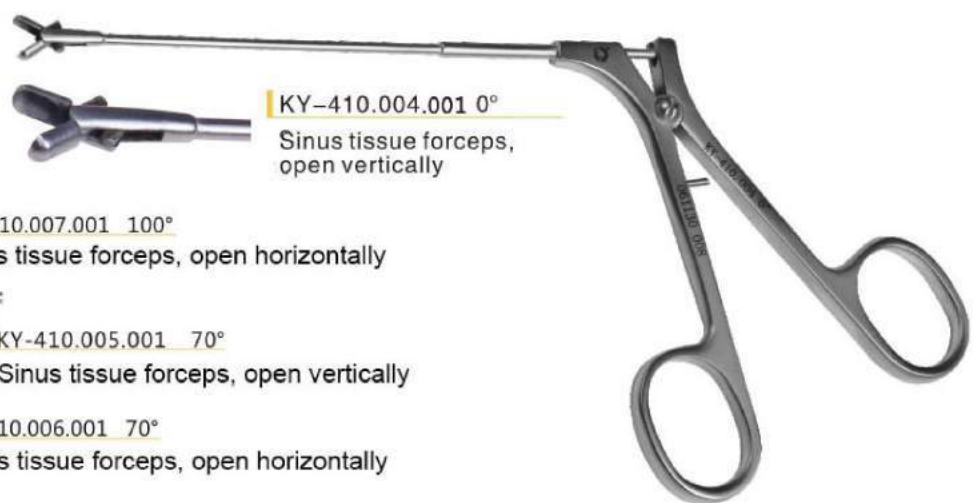

KY-410.004.001 0°
Sinus tissue forceps, open vertically



KY-410.007.001 100°
Sinus tissue forceps, open horizontally



KY-410.005.001 70°
Sinus tissue forceps, open vertically



KY-410.006.001 70°
Sinus tissue forceps, open horizontally



KY-410.023.001 200
Sickle-shaped knife, sharp



KY-410.025.001 200
Sinus curette, no hole



KY-410.026.001 200
Elevator, single head



KY-410.024.001 200
Sickle-shaped knife, blunt



KY-410.025.002 200
Sinus curette, with hole



KY-410.031.001 ϕ 4.0x100
Trocar



KY-410.016.001 0° /125/
Tissue forceps, for nasal cavity, suction



KY-410.019.001 90°
Maxillary rongeur



KY-410.008.001 ϕ 4x125mm
Rongeur, forward



KY-410.013.001 90° ϕ 4x125mm
Tissue forceps, for nasal cavity



KY-410.018.001 45° ϕ 4x125mm
Tissue forceps, for nasal cavity



KY-410.009.001 ϕ 4x125mm
Rongeur, backward



KY-410.014.001 0°
Tissue forceps, for nasal cavity, bowl-shaped



KY-410.019.001 90°
Maxillary rongeur



KY-410.010.001 ϕ 4x125mm
Nasal tissue scissors, straight



KY-410.015.001 30° ϕ 4x125mm
Tissue forceps, for nasal cavity, right curved



KY-410.020.001 0° /125/
Tissue forceps, for nasal cavity, spoon-shaped



KY-410.011.001 ϕ 4x125mm
Nasal tissue scissors, right curved



KY-410.016.001 0° /125
Tissue forceps, for nasal cavity, suction



KY-410.021.001 0° /125
Tissue forceps, for nasal cavity



KY-410.012.001 ϕ 4x125mm
Nasal tissue scissors, left curved



KY-410.017.001 45°
Tissue forceps, for nasal cavity, suction



KY-410.022.001 0°
Optical forceps

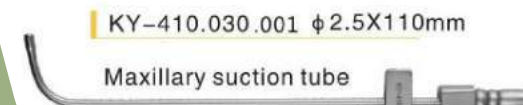

KY-410.030.001 ϕ 2.5x110mm
Maxillary suction tube

KY-410.027.001 ϕ 2.5x175 mm
Suction tube, curved
KY-410.028.001 ϕ 3.0x175 mm
Suction tube, curved
KY-410.029.001 ϕ 3.6x175 mm
Suction tube

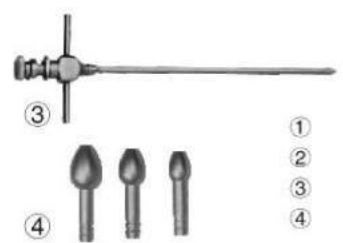

① Nasal bone restorer
② Adenoid box dissecting knife
③ Maxillary trocar
④ Olive-shaped head (large/middle/small)



KY-126 0° ϕ 4X45mm

Otoscope

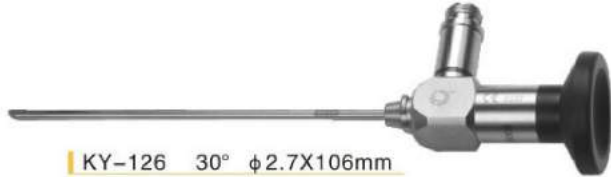

KY-126 30° ϕ 2.7X106mm

Otoscope

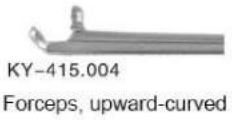

KY-415.004
Forceps, upward-curved

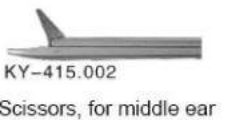

KY-415.002
Scissors, for middle ear



KY-415.001
Malleus forceps



KY-415.005
Forceps, straight

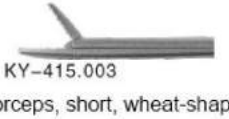

KY-415.003
Forceps, short, wheat-shaped

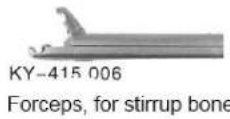

KY-415.006
Forceps, for stirrup bone



KY-415.004
Forceps, upward-curved

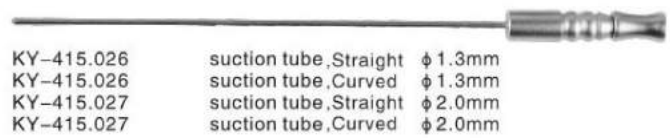

KY-415.026 suction tube, Straight ϕ 1.3mm
KY-415.026 suction tube, Curved ϕ 1.3mm
KY-415.027 suction tube, Straight ϕ 2.0mm
KY-415.027 suction tube, Curved ϕ 2.0mm



KY-415.025 ϕ 1mm
Hook



KY-415.007
Elevator



KY-415.012
Knife, for stirrup bone



KY-415.016
Curette, left curved



KY-415.020
Flat chisel



KY-415.024 ϕ 1mm
Hook, blunt



KY-415.008 ϕ 2.2mm
Curette



KY-415.013
Knife, straight



KY-415.017
Curette, right curved



KY-415.021
Stirrup bone drill



KY-415.025 ϕ 2mm
Hook, blunt



KY-415.009 ϕ 2.0mm
Curette



KY-415.014
Elevator, straight



KY-415.018
Round chisel, straight



KY-415.022
Needle, for stirrup bone, straight



KY-415.025 ϕ 2mm
Hook, sharp



KY-415.010
Cutting knife, sharp



KY-415.015
Curette, curved



KY-415.019
Round chisel, curved



KY-415.023 70°
Needle, for stirrup bone



KY-415.011

KY-411.002

Self-retaining laryngoscope set, large, with optical fiber



Laryngoscope



Laryngoscope



KY-411.005 ϕ 2.5X255mm

Micro-larynx scissors, straight

KY-411.008 ϕ 2.5X255mm

Micro-larynx scissors, upward 45°

KY-411.011 ϕ 2.5X255mm

micro-larynx larynx forceps, bowl-shaped, straight

KY-411.006 ϕ 2.5X255mm

Micro-larynx scissors, left curved

KY-411.009 ϕ 2.5X225mm

Micro-larynx forceps, straight

KY-411.014 ϕ 2.5X255mm

Micro-larynx forceps, bowl-shaped, left curved

KY-411.014
micro-larynx forceps

KY-411.007 ϕ 2.5X255mm

Micro-larynx scissors, right curved

KY-411.010 ϕ 2.5X255mm

micro-larynx forceps, bowl-shaped, upward

KY-411.015 ϕ 2.5X255mm

Micro-larynx forceps, bowl-shaped, right curved

KY-411.016 ϕ 2.5X255mm

micro-larynx porceps, alligator

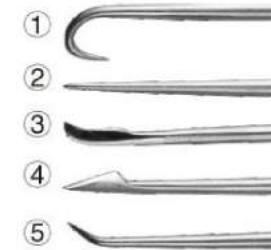

① KY-411.019 ϕ 2.5X255mm larynx hook
② KY-411.018 ϕ 2.5X255mm larynx needle
③ KY-411.017 ϕ 2.5X255mm laryngotome
④ KY-411.017 ϕ 2.5X255mm laryngotome
⑤ KY-411.019 ϕ 2.5X255mm larynx hook

KY-411.020
Handle

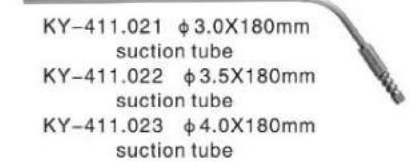

KY-411.021 ϕ 3.0X180mm suction tube
KY-411.022 ϕ 3.5X180mm suction tube
KY-411.023 ϕ 4.0X180mm suction tube



Mouth gag with fiber

Anesthetic syringe

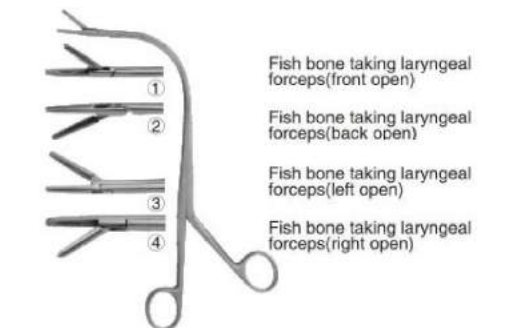

① Fish bone taking laryngeal forceps (front open)
② Fish bone taking laryngeal forceps (back open)
③ Fish bone taking laryngeal forceps (left open)
④ Fish bone taking laryngeal forceps (right open)

Sigmoidoscope & accessories



KY-412.001 ϕ 4.0X260mm

Bronchoscope

KY-412.002 ϕ 4.5X280mm

Bronchoscope

KY-412.003 ϕ 5.0X280mm

Bronchoscope

KY-412.004 ϕ 5.5X300mm

Bronchoscope

KY-412.005 ϕ 6.0X300mm

Bronchoscope

KY-412.006 ϕ 2.0X360mm

Foreign body forceps, for trachea



KY-412.007 ϕ 2.0X360mm

Foreign body forceps, for trachea, peanut-shaped

KY-412.008 ϕ 2.0X360mm

Foreign body forceps, for trachea, alligator

KY-412.006 ϕ 2.0X360mm

Foreign body forceps, for trachea, wheat-shaped

KY-412.009 ϕ 2.0X360mm

Foreign body forceps, for trachea, three-prong

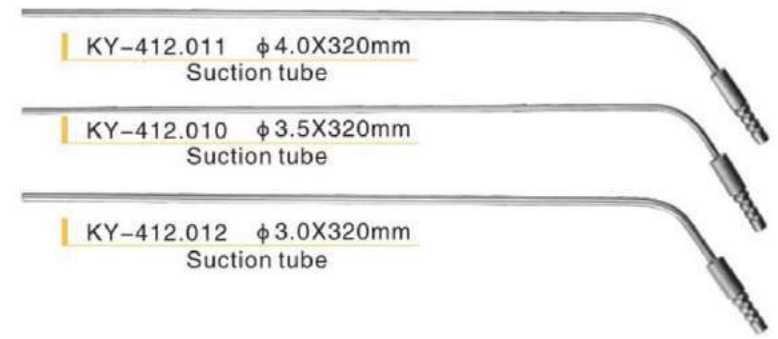

KY-412.011 ϕ 4.0X320mm
Suction tube

KY-412.010 ϕ 3.5X320mm
Suction tube

KY-412.012 ϕ 3.0X320mm
Suction tube



KY-180.01 ϕ 4X1800mm

Fiber Optic cable

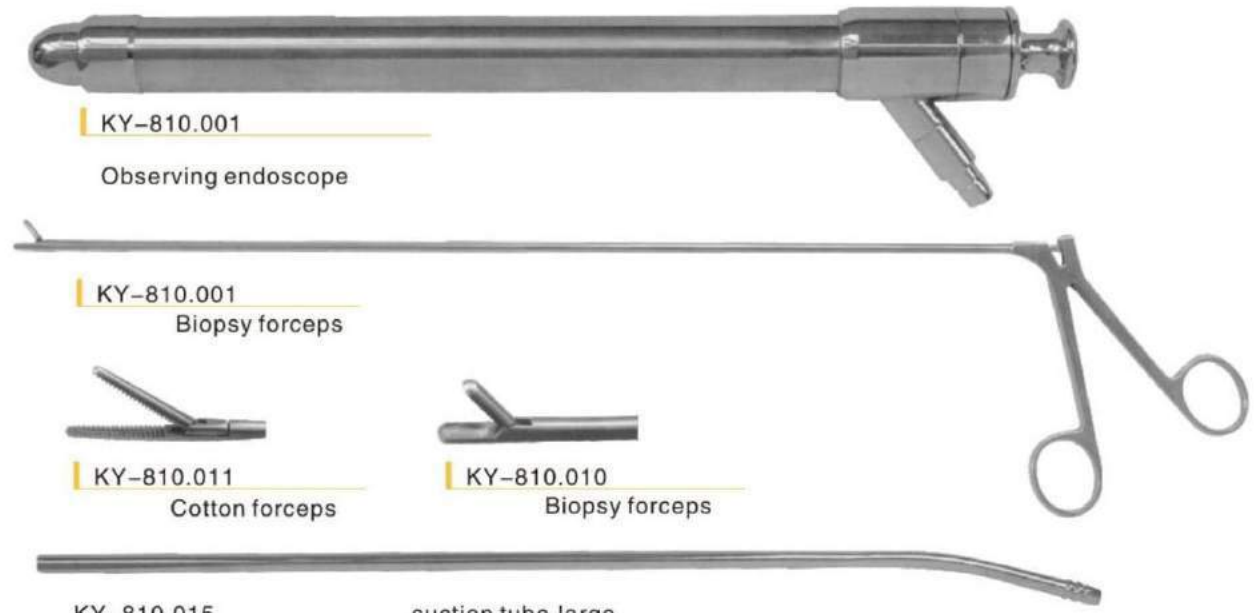

KY-810.001

Observing endoscope

KY-810.001

Biopsy forceps

KY-810.011

Cotton forceps

KY-810.010

Biopsy forceps

KY-810.015
KY-810.016

suction tube, large
suction tube, small

Esophagoscope & accessories

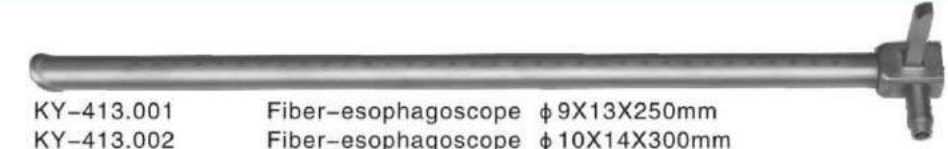

- KY-413.001 Fiber-esophagoscope ϕ 9X13X250mm
- KY-413.002 Fiber-esophagoscope ϕ 10X14X300mm
- KY-413.003 Fiber-esophagoscope ϕ 11X15X350mm
- KY-413.004 Fiber-esophagoscope ϕ 12X16X380mm
- KY-413.005 Fiber-esophagoscope ϕ 13X17X400mm

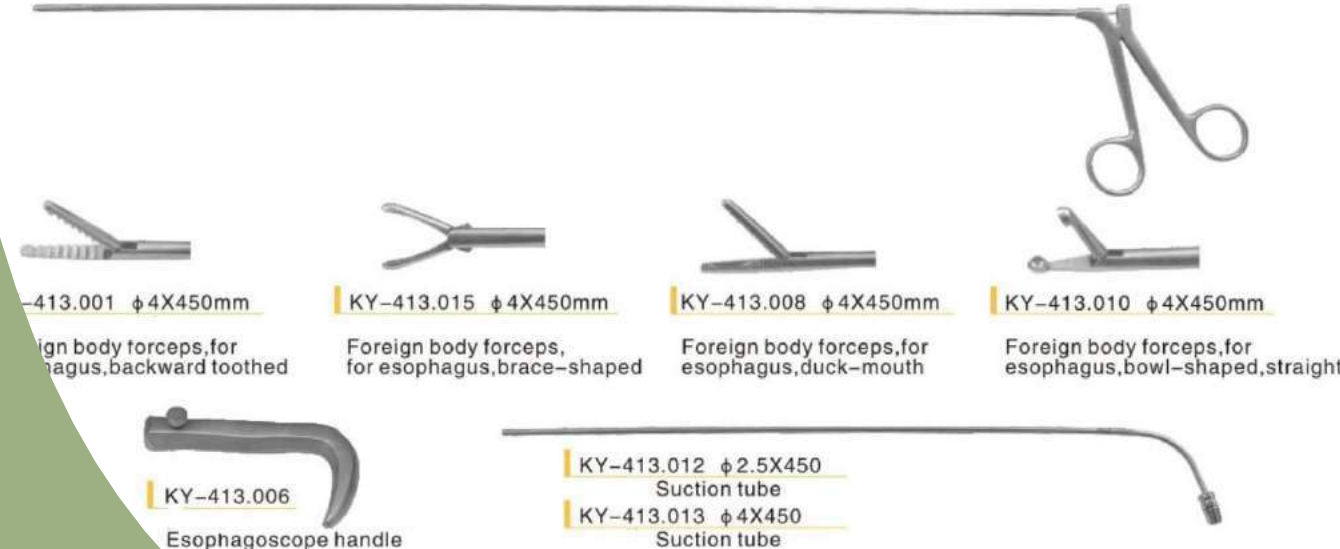

KY-413.001 ϕ 4X450mm

Foreign body forceps, for esophagus, backward toothed

KY-413.015 ϕ 4X450mm

Foreign body forceps, for esophagus, brace-shaped

KY-413.008 ϕ 4X450mm

Foreign body forceps, for esophagus, duck-mouth

KY-413.010 ϕ 4X450mm

Foreign body forceps, for esophagus, bowl-shaped, straight

KY-413.006

Esophagoscope handle

KY-413.012 ϕ 2.5X450

Suction tube

KY-413.013 ϕ 4X450

Suction tube

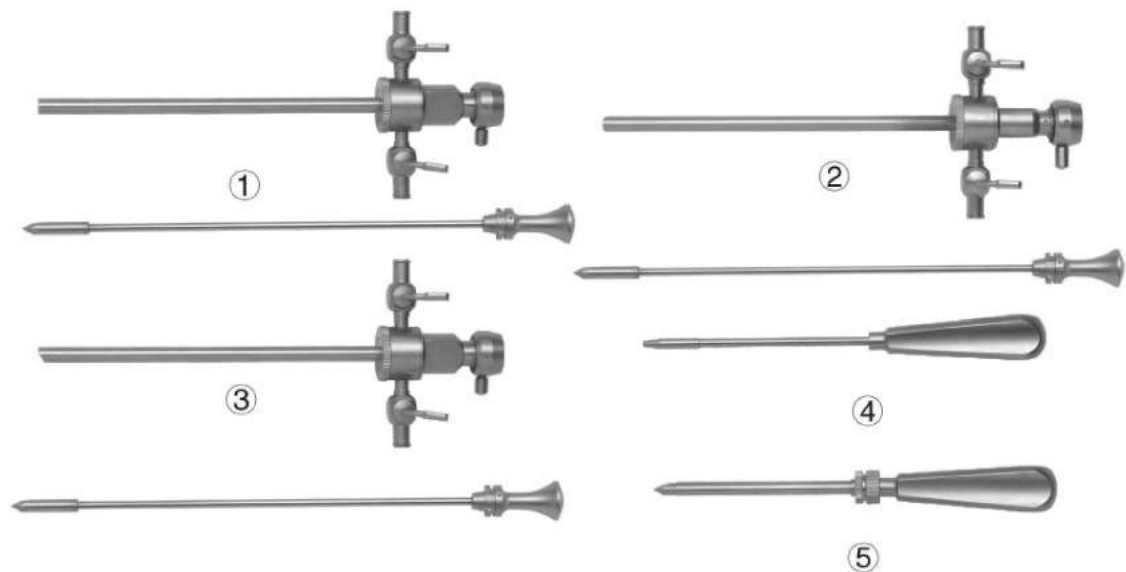
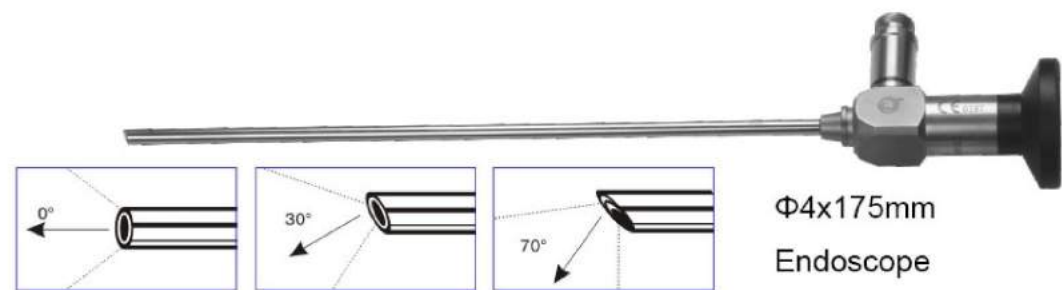

- ① KY-610.004.001 0° φ5.5X140mm Sheath, with two stopcocks
- ② KY-610.004.001 30° φ5.5X140mm Sheath, with two stopcocks
- ③ KY-610.004.001 70° φ5.5X140mm Sheath, with two stopcocks
- ④ KY-610.036.001 φ4.7X120mm Trocar, rhomboid
- ⑤ KY-610.036.002 φ4.7X120mm Trocar, blunt

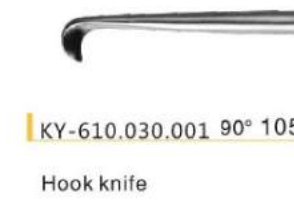
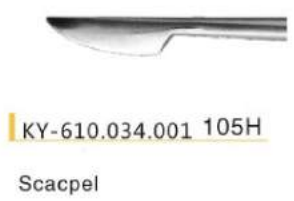
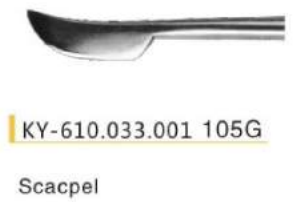
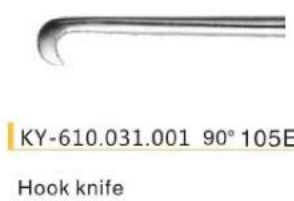
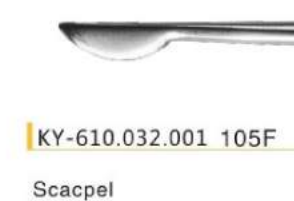
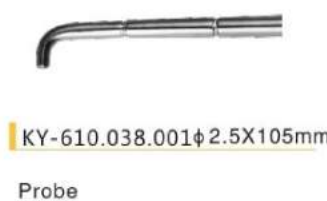



KY-610.012.001 ϕ 3.5X135mm
Punch forceps(Cutting forceps)



KY-610.019.001 ϕ 3.5X135mm
Scissors,hooked,straight



KY-610.011.001 ϕ 3.5X135mm
Biopsy forceps, with spike



KY-610.015.001 45°
Rongeur



KY-610.020.001 ϕ 3.5X135mm
Scissors,left curved



KY-610.012.001 ϕ 3.5X135mm
Punch forceps,straight (Cutting forceps)



KY-610.016.001 135A
Synovium forceps



KY-610.021.001 ϕ 3.5X135mm
Scissors,right curved



KY-610.013.001 ϕ 3.5X135mm
Punch forceps,left curved



KY-610.017.001 125B
Synovium forceps



KY-610.014.001 ϕ 3.5X135mm
Punch forceps,right curved

Adaptor for WOLF endoscope

Adaptor for WOLF cold light source

Adaptor for OLYMPUS cold light source

Adaptor for ACMI light guide cable

Adaptor for ACMI,STRYKERendoscope

Adaptor for STRYKER light guide cable

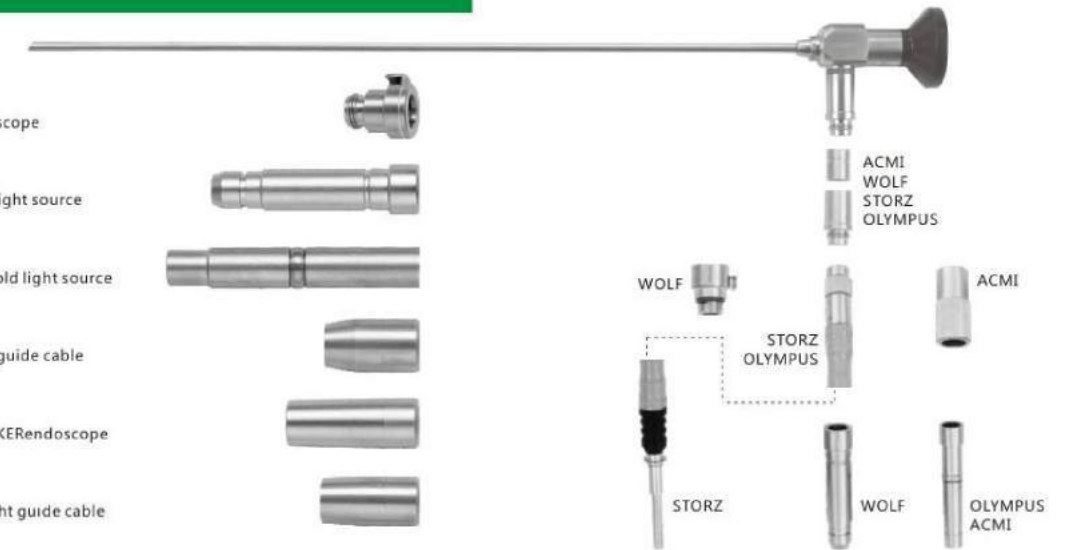

Laparoscopy instruments
901.101 540x230x70

Laparoscopy instruments
901.102 550x250x70

Hysteroscope
901.103 380x130x85

Resectoscope
901.109 420x280x90

Electric uterus-cutter (complete set)
901.105 540x250x135

Laryngoscope (complete set)
901.107 435x210x90

Esophagus endoscopic instruments
(complete set)
901.131 570x260x70

Cystoscope (complete set)
901.110 530x230x90

Ureteroscopy (two pieces)
901.112 730x200x100

Gallbladder device
901.126 540x270x90

Soak disinfection box
901.115 560x260x180 (laparoscope)
901.116 480x210x108 (cystoscope)

Flexible endoscope
901.129 540x251x100

Surgical instruments (single layer)
901.304 550x210x50

Hysteroscopy
901.320 420x210x50

Surgical instruments (three layers)
901.307 550x250x130

Endoscope (laparoscope, cystoscope)
901.124 448x84x42

Ureteroscopy (one piece)
901.111 700x150x70

Ureteroscopy (export)
901.111 700x150x70

Endoscope (otoscope, sinoscope)
901.125 293x84x42



JULLUNDUR ENTERPRISES

ISO : 9001 : 2008 Certified Co.
CE Certified Co.



Physiotherapy Products Catalogue

JULLUNDUR ENTERPRISES

ADDRESS : 1568-A, G-22-23,
BHAGIRATH PALACE
DELHI 110006

MOBILE : +91 9871432046
+91 9312281439
+91 9810660343

TELEPHONE : +91 11 23860283
+91 11 23860035 (FAX)



JAS-ANZ



M3111204IN

EMAIL : maanik@jemediguard.com
info@jemediguard.com
WEBSITE : www.jemediguard.com

Physio Therapy Product

Laser Therapy Cluster Probe

The Laser Unit Is Beneficial In Following Indications.

1. Cervical spondylosis
2. Tennis elbow
3. Osteoarthritis
4. Muscular pain
5. Wound healing
6. Nerve regeneration
7. Soft tissue injury
8. Skin treatment
9. Chronic degenerative disease
10. Frozen shoulder
11. Plantar fasciitis

Special Features

1. International standards & specifications.
2. Cluster probe with one central emitter & six peripheral emitters enhancing faster results.
3. Elastic fasteners to avoid long holding by the therapists.
4. Larger covering of the affected area.
5. Light weight & easy to operate.
6. Plastic moulded cabinet with large LCD display.
7. Laser protective goggles.

Technical Specifications

1. Laser medium: GaA/As-Semiconductor.
2. Terminal laser output: terminal output maximum for probe of laser emitter: $500\text{mW} \pm 10\%$ teh exit facula diameter of laser beam $\leq 10\text{mm}$.
3. Probe central laser output wavelength: $(810 \pm 30)\text{nm}$.
4. Beam divergency angle: $\mu x = 0.26 \text{ red}$, $\mu y = 0.78 \text{ red}$.
5. Laser output power instability $St \leq 10\%$
6. Probe peripheral laser wavelength: $650\text{nm} \pm 30\text{nm}$.



Laser Therapy Unit (Pen Probe)

The Lasermed product range comprises two device that differ in the number of output : 1 output of Lasermed (2100)

Automatic setting of treatment time in accordance with power supplied and the scanning area selected

Transmitting power set in accordance with the treatment time and scanning area selected

Supplied with MLA1-25 probe.

Technical Specifications

- Mode : Continuous & pulse mode.
- Maximum probe power : 100 mw
- Beam Surface : 0.025 cm²
- Laser type : Semiconductor GaAs
- Wave type : 650 nm
- Power density : 0.8 w/cm²
- Max energy within 1 min 1 joules



Physio Therapy Product

Long Wave Diathermy

Long wave is much better and superior modality for relieving pain as compared to shortwave and ultrasonic.

Here are some comparisons which make long wave better than other modalities.

1. long wave works at 1 Mhz whereas short wave works at 27.12Mhz. since long wave works at less frequency there will be minimum energy loss.
2. In shortwave diathermy heat is produced due to molecular friction that's why tissue destruction is seen which is not the case in long wave diathermy.
3. Long wave diathermy produces a maximum output of 25 watts whereas shortwave produces output in the range of 250-1000 watts.
4. Long wave can be used in the patients with the metallic implant.
5. Unlike shortwave long wave do not produce any interference with other equipment nearby.
6. Heat produced by long wave remains for 45 minutes.
7. Long wave has a deeper penetration of 40 mm.
8. In this most of the energy remains in high density tissues like ligaments and tendons.
9. long wave is highly portable modality weighing around 6-7kgs. Only.



Technical Specifications

- | | |
|---------------|--------------------------------|
| 1. WAVELENGTH | : 300 meter |
| 2. FREQUENCY | : 1 Mhz |
| 3. DISPLAY | : back light display |
| 4. TIMER | : 0-5 minutes |
| 5. POWER | : variable in 16 digital steps |
| 6. MAINS | : 230 v, 50 Hz |
| 7. WEIGHT | : 7-8 kg |

Surgical Cautery (250w) Semi Digital Solid State

Technical Specifications

- | | |
|--------------------------------|---------------------------------|
| Rated Frequency | : 450Khz |
| Pure Cut HF Voltage wave form | : Unmodulated Sinusoidal |
| Blend Cut HF Voltage wave form | : Modulated Sinusoidal |
| Max HF Power | : 250 watt/500 Ohms Load |
| Monopolar Coag : Max HF Power | : 160 watt/500 ohms Load |
| Wave form | : Modulated Sinusoidal |
| Bipolar Cut : Max HF Power | : 100 watt/150 Ohms Load |
| Wave form | : Unmodulated Sinusoidal |
| Blend : Max HF Power | : 80 watt/125 Ohms Load |
| Wave form | : Amplited Modulated Sinusoidal |
| Bipolar Coag : Max HF Power | : 80 watt///125 Ohms Load |
| Wave form | : HF Modulated sinusoidal |



Surgical Cautery (400w) Semi Digital Solid State

Technical Specifications

- | | |
|------------------|--|
| Output Frequency | : Mone Polar Generator 500 Khz + 25Khz |
| Puri Cut | : 400 watts at 500 Ohms Load |
| Blend II Cut | : 300 watts at 500 Ohms Load |
| Blend I Cut | : 225 watts at 500 Ohms Load |
| Coagulation | : 160 watts at 500 Ohms Load |
| Bipolar Coag | : 100 watts at 125 Ohms Load |
| Spary Coag | : 100 watts at 125 Ohms Load |



Physio Therapy Product

Knee Laser Pain Relief Module



Knee Laser Pain Relief Module Is An Advance Therapy Device Which Is Provided With Laser Radiation Technology Combined With Three Dimension Massage Technique. It Basically Improve Microcirculation And Metabolism In The Radiating Area. In Addition To This , It Improves Tensile Strength Of The Tissues , Eliminates Inflammation , Reduces Oedema And Stiffness In The Tissues Thereby Providing Relief From The Pain.

Highly Precisely Placed Laser Light And Laser Emitting Diodes (650 Nm) Combined With Massage Accelerates Blood Circulation , Promotes Muscle Metabolism , Relieves Symptoms Of Knee Joint Disease. Moreover Laser Radiations Stimulates The Activation Of Satellite Cells On Muscle Fibres , Accelerating The Self Healing Effect. Thus To Accelerate Pain – Relief And Enhance Physical Function Recovery.

INDICATIONS

1. Rheumatoid Arthritis
2. Osteoarthritis
3. Acute Knee Pain
4. Ligament Tear
5. Soft Tissue Injury
6. Knee Swelling

Technical Specifications

Laser Type	: Semiconductor Diode Type Laser Radiations
Weight	: 400 Gms.
Ambient Temperature	: 5 – 40 ° C
Relative Humidity	: < 80 %
Power Supply	: 6 V Dc , 2 A (Power Adaptor)

Back Pain Relief Laser



Intelligent Position Massage and Fatigue Relief

Waist Care Massager combines Massage, pressure kneading vibration and laser irradiation technologies together.

It can improve the blood circulation, enhance the strength of lumbar and help to recover the stability.

Moreover, it play an important role in the supporting and protection of lumbar.



Technical Specifications

Model:	RG-JYB 612-I
Light Medium :	LD, LED
Weight :	400g
Ambient Temperature:	5°C ~ 40°C
Humidity:	≤ 800 %
Supply :	DC6.0V, 2A (Power Adaptor)

Physio Therapy Product

Microwave Multifunction Therapeutic Apparatus

Indications

- # Sport system: parenchyma wound wrench, fracture, osteomyelitis, slipped disc, rheumatoid arthritis; penarthrits of shoulder etc.
- # Urology system: urology system infection and evocable kinds of inflammation.
- # Shallow tissue inflammation: infection of surgical cut, folliculitis, furuncle, carbuncle, psoriasis, herpes zoster, bedsore, hemorrhoids, scald, chilblain, faucitis, tonsillitis, bronchitis ect.
- # Nerve system: end neuritis, neurodermatitis, neurodocitis, neuralgia ect.

Normal Operating

- # Temperature: + 10°C-+40°C.
- # Relative humidity: 30%-75%.
- # Atmospheric pressure: 700hpa-1060hpa,
- # Power supply: AC220V±22V 50Hz±Hz
- # Preheat time >_ 3 minutes.

Performance Index:

- # Output power: a) therapy: 1-100W±30%; b) physiotherapy: 1-40W±30%
- # Operating frequency: 2450MHz±50MHz.
- # Control mode: a) By foot pedal : the therapy output is controlled through foot pedal. b)Automatic control: set time from 1 to 99 minutes. Digital timer display
- # Maximum time error± 1 minute.
- # Output impedance: 50 Ω
- # Uninterrupted operation time:>_ 8 h.
- # Output power:< 450VA.
- # The standing wave ratio of radiator is not grater than 3.



Lymphopress Air Compression Therapy



INDICATIONS

1. LYMPH OEDEMA
2. DEEP VENOUS THROMBOSIS (DVT)
3. VARICOSE VEINS
4. DISEASE BY INTERRUPTION IN BLOOD CIRCULATION
5. SWELLING IN THE LEGS
6. RELAXATION IN CASE OF MUSCLES FATIGUE AND INSOMNIA.
7. LIMB PARALYSIS (CEREBRAL INFARCTION)
8. PAIN MANAGEMENT
9. PREGNANT WOMENS LIMB MANAGEMENT
10. CHRONIC DISEASE BY VENOUS CAUSE
11. FAT DISSOLUTION
12. RHEUMATOID ARTHRITIS
13. IMPROVEMENT OF INTESTINES , DISSOLUTION AND CONSTIPATION.
14. BENUMBED FEETS .

All functions inside the body are operating by the smooth circulation of blood and lymph.

It promotes the circulation of blood and lymph in the disabled regions of the arms and legs, and increases the pressure of the muscular tissue by continuously repeating swelling and contraction with the 4-step gradual air pressure, thus curing edema and pain in the arms and legs and recovering the function of the limbs aged or disabled due to diseases.

The limbs pressure and circulation device is an instrument for the cardiovascular system, which prevents the pool or blockage of blood or blood circulation.

Blood circulation disorders show the symptoms of cold hands and legs, numbness, pain in the shoulder, failure of memory, dizziness, chronic fatigue, difficulty in walking due to pain, muscular pain, cold feeling in the feet, paralytic feeling in muscles and skin, signs of paralysis, senile dementia and there is much possibility those who have diabetes, hyperlipidemia, hypertension, heart disease, or smoke have blood circulation disorders.

Physio Therapy Product

Continuous Passive Motion (C.P.M.) Imported



Knee CPM

Technical Specifications

- # CPU control. Colour LCD dual displays.
- # Knee sensor makes running angle more accurately, also the moment can be selected.
- # Digital setting of angle, speed, time.
- # Special design of the support bar suiting to human curve.
- # Suit to adult less than 1.9m.



Shoulder & Elbow CPM

Technical Specifications

- # CPU and LCD screen display control setting.
- # Motion angle, speed and time can be controlled and displayed.
- # Patient's shoulder and elbow can alternately exercise through exchanging the supporting frames.
- # Return automatically for over-load protection.
- # Rational mechanical structure design, move conveniently.
- # Power supply : 220V~, 50HZ.
- # Input Power : <60VA
- # Range of motion angle : 0°~150°.



Ankle CPM

Technical Specifications

- # Joint axis motion mode, ankle can move naturally.
- # Motion angle, speed and time all can be controlled by digital equipment.
- # Big LCD screen display setting.
- # Return automatically for over-load protection.
- # The hand controller can stop machine.



Elbow CPM



Elbow CPM



Finger CPM

Physio Therapy Product

Short Wave Diathermy 500 Watts

Most common and globally used modality designed to run many hours constantly to complete the rush of patient. This heavy duty device has its various versatile indications.



Technical Specifications

Power Output : 500Watt of R.F.
Operating Frequency : 27.12 MHz (App.)
Wave Length : 11.06 Meter (App.)
R.F. Source : 220 Volts generating Valve



**Solid State SWD 500W
(LCD Model with 20 Protocols)**

Short Wave Diathermy 250 Watts

Technical Specifications

Power Output : 500Watt of R.F.
Operating Frequency : 27.12 MHz (App.)
Wave Length : 11.06 Meter (App.)
Main Supply : 220 Volts generating Valve



**Solid State SWD 250W
(LCD Model with 20 Protocols)**

I.F.T. Vacuum

Is a modular, compact vacuum therapy machine. The unit is light weight and versatile. It simplifies the placement of treatment electrode in electrical. I.F.T. MANUAL & I.F.T. PROGRAMMABLE UNIT can be combined with VAC thus eliminating the need to bandage & wrap electrodes which can restrict blood flow & inhibit muscle contraction. In addition, it has tremendous advantage when treating difficult areas such as shoulders, knees & neck which are extremely difficult with bandage wraps.

The unit offers more than just secure placement of electrodes. The suction rate combined with vacuum offers the additional advantage of pulsed massage stimulation.

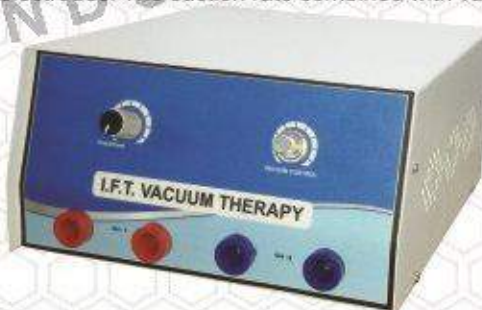

Physio Therapy Product

Digital Cervical Lumber Traction

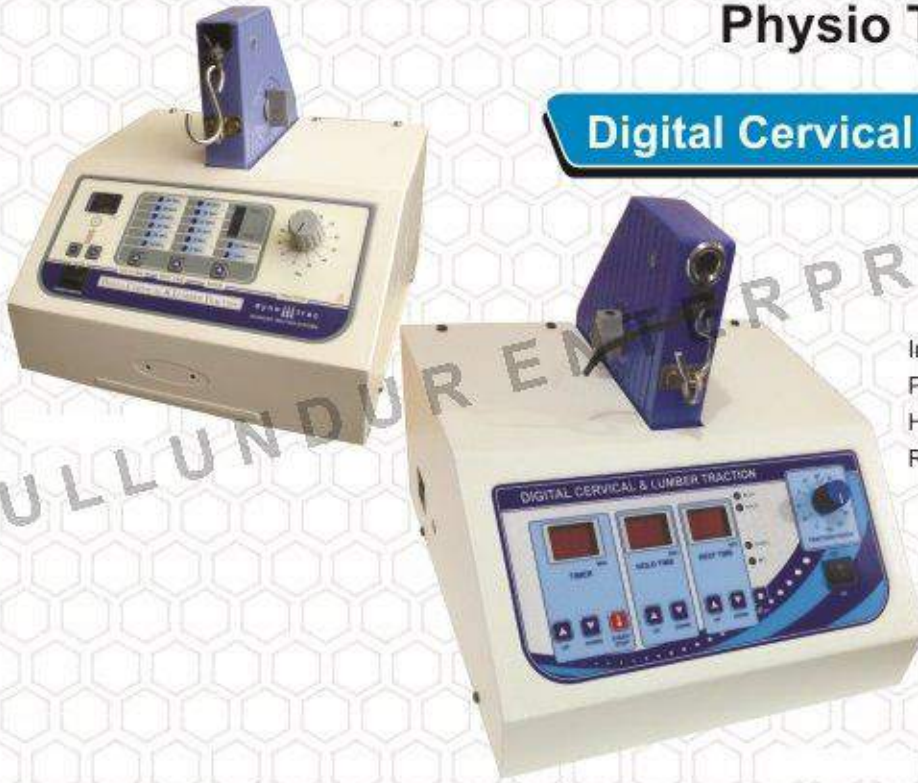

Technical Specifications

Input Voltage	: 220/240 Volt A.C. 50 Hz
Power Consumption	: 100 Watt (Approx)
Hold Time	: 20, 40, 60, 80, (Seconds)
Release Time	: 1, 15, 20, (Seconds)

Traction Table Unit



Three Fold Bed



Four Fold Bed

Continuous Passive Motion (C.P.M.)

Input Voltage	: 220V AC/50Hz
Treatment Time	: 0/99 min
Power Consumption	: 35w Max.
Flexions hold time	: 0-9 Sec.
Extensions hold time	: 0-9 Sec.
Flexion Angle	: 5°-120°



Physio Therapy Product

Interferential Therapy Unit



IFT 29 Program



IFT LCD 70 Program

Technical Specifications

Input Voltage	: 220V/Ac 50 Hz	Sweep Freq.	: 0-100 Hz
Display	: FND Display	Therapy Modes	: 4 PIFT, 4 P Vector, 2P modulation
Intensity	: 99mA	Sweep Program	: Rectangular Wave - 1/1
IFT Medium Freq.	: 4 KHz	Triangular Wave	: 2/2
IFT Muscle Exec.	: 2 KHz	Trapezoidal Wave	: 6/6 Paraffin Wax Bath
Base Freq.	: 0-150 Hz		

Digital Muscle Stimulator



Technical Specifications

Input Voltage	: 220 A.C. 50 Hz
Galvanic	: Maximum output 100 Volt.
Interrupted galvanic	: A Switch to select 4 different mode of frequency
Faradic	: Compriser 40 pulse of 0.9 ms. each pulse of 0.9 ms
Surge Faradic	: Step less control to increases

Physio Therapy Product

Digital Ultrasonic Therapy Unit



Handy Ultrasonic



Technical Specifications

- Power Output : 15 watts in continuous mode
- : 21 watt in pulse mode
- Output mode : Continuous mode & pulse mode
- Timer : 0 to 30 mins (Digital)
- Main supply : 220 V 50 cycles
- Output : Digital display
- Pulse Mode : 1:10, 1:7, 1:4, 1:1



Transcutaneous Electrical Nerve Stimulation (T.E.N.S.)

TENS 4 CHANNEL is fully digital with digital treatment time along soft touch key for treatment mode selector & output mode selection. Application Pain relieve very effectively in Arthritis, Neuralgia, Migraine, Spinal Disc, Surgical Trauma, Headache, Sciatica etc.

Technical Specifications

- Operating Voltage : 220V AC 50 Hz
- Frequency : 2, 10, 50, 100, & 125 Hz
- Node : Burst-1, Cont, Burst-2, PWM, Sweep, Combi,
- Maximum Output Power : 100V (Peak to Peak)
- Timer : 01-99 mins



Physio Therapy Product

Combination Therapy



I.F.T. + U.S. + T.E.N.S. + M.S. (4-IN-1)



I.F.T. + T.E.N.S. + M.S.



4 CHANNEL T.E.N.S.



LCD 6 CHANNEL T.E.N.S.



COMBI 3 IN 1 I.F.T. + T.E.N.S. + U.S.



COMBO M.S. + T.E.N.S.



COMBO MINI T.E.N.S. + M.S.



COMBINATION T.E.N.S. + U.S.

Rehabilitation Product



Hand Exerciser Table



Staircase



Parallel Bars



Wooden Couch



Quadriceps Table



Gripper Ex.



Shoulder Wheel



Pedo Cycle



Rotary Wrist Machine



Shoulder Wheel



Finger Ladder



Heel Exerciser



T-Pully



Ankle Exerciser



I.R. Lamp



Hand Gym Kit Board



Weight Cuf Set



Fat Analyser



Hydrocollator



Wax Bath



Gym Ball



Weighing Scale



High-low Treatment Table



TILT TABLE (Electrical)

SHOULDER WHEEL WALL MOUNTING

Wall Mounting heavy shoulder wheel tubular circle of 100cm dia, mounted on bush bearing With calibrated resistance 360° revolution, adjustment bar to raise up and release down as per the Height requirement fitted on a laminated board frame.



INFRA RED LAMP

Table top model for IR radiation treatment. IR bulb of 150w is Fitted in a metal casing.



SHOULDER EXERCISER COMPACT MODEL

A wall mounting device for, shoulder, Arm and Pronation/supination exercise, adjustable in height and radius, resistance can be increased by Tightening the strap. Chrome plated adjustment Bar along with attachment for wrist exercise.



VIBRATORY BODY MASSAGER

Electrically operated Hand held light weight massager and easy to use, enable you to apply the massager to any part of the body high power and multi direction vibration give a hand like massage effect.



MULTI EXERCISER CHAIR

A Tubular steel contraction duly painted exercise Chair with weight & pulley, strap and handles along With chair for sitting. This gadget is used as overhead pulley system for variety of exercises elbow, shoulder, knees and hips, quadriceps and arm strong stretching and other resistive and assistive exercise.



Multi Exerciser Table

Specify designed table with laminated top fitted with 6 pulleys in a steel frame loops and nylon cord passing through the pulleys with hanging weight underneath for fingers, hand, wrist and forearm exercises, the table is provided with supination/pronation and wrist circumduction for wrist exercises, supplied with 5 sets of weight, each set comprises of 5 weights of one each of 100,200,300,400 and 500 grams.



WRIST CIRCUMDUCTOR

A iron wheel mounted on a laminated wooden base has a small Adjustable handle fitted to the wheel. A knob is provided at back of the wheel to control resistance 0 to maximum. Hollowed foam Padded platform fitted with two straps to hold arm and is fitted over the base in front of the wheel for wrist circumduction.



STEPPER

Shock absorber type stepper exercises with odometer portable floor model.



GRIP EXERCISER

Chrome plated finished metallic frame grip exerciser fitted on laminated wooden base consist heavy resistance with six detachable Springs.



PEG BOARD

A wooden peg board duly sun mica laminated with multicolors pegs.



HAND GYM KIT BOARD (FINGER & HAND EXERCISER)

Laminated exercise board with storage drawer, have several holes for fixing pegs and springs. Comes with one finger disc, one roller, three spring loaded knobs, 3 aluminium pegs and 3 sets of springs of different tension, Hand Gym Board permits active flexion and extension exercises of the finger & grip.



MEDICINE BALL

Medicine Exercise balls made of leather in different size & weight.



ANKLE EXERCISER

An aluminum casted foot step duly painted and fitted on a laminated wooden base fixed with steel brackets, having two springs for, Doris and planter flexion, exercises, resistance can be controlled for increasing or decreasing by further tightening the nuts of both the spring and the flexion angle can be measured and recorded.



ROWING MACHINE

Tubular steel frame with chrome plated finish. Specially Designed foam padded seat is fitted on 4 nylon castors And slides smoothly over the frame. Five chrome plated springs are Provided for resistive leg and arm exercise.



HEEL STRETCHER

A steel sock absorber based specially developed device for the Exercise of heel and tarsus muscle groups, is fitted on a Laminated wooden base and can be used for exercise while Sitting on a chair or a stool. The resistance can be increased or decrease by aluminum footstep up / down on the lever.



SHOULDER/FINGER EXERCISER (Abduction Ladder)

Ideal for programming range of shoulder motion, made of polished teak wood having 30 number steps for shoulder abduction exercises.



WHIRLPOOL BATH

Made of S. S. Heavy gauge steel sturdy and well finished with aluminum seat and arm rest, duly fitted with a motorized turbine ejector, and aerator, a digital temperature, indicator, and controller and fitted with immersion concealed heaters, over all size of the unit is 90 cm x 50 cm x 70 cm deep mounted on heavy duty 10 cm dia wheels.



TILT TABLE

Manually operated tilt table with foam padded top is provided with three straps to hold the patient. Works to standing position with worm gear arrangement. Range of tilt is calibrated from 0-90 degrees. Table comes complete with an Utility tray.



GONIO METER-A

A simple & accurate devices for measuring range of motion stainless steel construction.

- (A) FINGER GONIO METER
- (B) 180°
- © 360°

GONIO METER-A



GONIO METER-B



GONIO METER-C



WRIST ROLL EXERCISER

One piece wooden rolls in three different diameters fitted to a board With adjustable friction control mechanism used for flexion and Extension exercises of wrist and forearm duly teak wood finished.



PASCHURUL MIRROR (MOBILE)

Best quality mirror size 180 x 60 cm protected by teakwood polished frame & Back with ply board supported by angular frame & mounted on a Tubular stand of 2 pieces fitted with 4 ball bearing rubber castors.



PARALLAL BAR

3 meter long walking bar have hand rails and upright stands are made of ms tubing duly painted mounted on 3 meter long wooden platform with both side inclined and pasted on the top platform non slipping matress, height and width adjustable by setting of chain and pins.

- (A) 10 x 2 ½ Ft Adj. H x W without P.F.
- (B) 10 x 2 ½ Ft Fix H x W with P.F.
- (C) 10 x 2 ½ Ft Adj. H x W with P.F.



TRACTION TABLE

An ergonomically designed three fold fixed up holstered traction table with hollowed cushioned top and sturdy construction of square use pipe duly rushed proof powder coated is idle for cervical and lumber traction purpose supplied with flexion stool and traction fixation attachment with vertically adjustable traction mounting top.



STATIC CYCLE EXERCISER

A ruggedly built tubular steel frame stands on two parallel welded steel pipe duly covered from both side by rubber cap, provided with adjustable cycle seat solid rubber tyre wheel crank and chain with paddles for cycling.

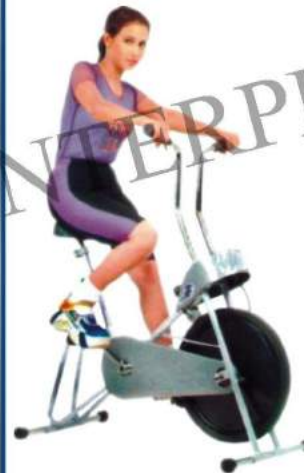

SUSPENSION FRAME

Tubular steel construction overall size 210cm x 110cm wide from base side. All steel rod mesh at the top for complete suspension, the mesh can be used for any desired angle for patients comfort and treatment point of view, complete with suspension gear comprising, 7 canvas slings (4 limb, 2 trunk, 1 head) 6 single ropes with hooks and cleats, 2 double pulley ropes, 8 springs, 4 s hook 2 ankle straps, supplied without bed.



JOGGER

Complete tubular contraction with computerized control, motorized and non motorized with sliding canvas belt, slanted from control side to another side, complete with folding.



STAIR EXERCISER CORNER TYPE

Two Sections corner type wooden exerciser case 30 inch wide one side 4 steps and the another side 6 steps, both side wooden hand rails duly teak wood polished and non-slipping mattress pasted foot steps.



DUMBBELLS (Each Kg.)

Solid steel dumbbells with chrome plated finish, a set consist of 6 dumbbells of each weight



EXAMINATION COUCH

Foam rubber padded top size 72 x 24 up holstered with maxim & adjustable back rest of 18" length which can be adjustable in height for desired position. Two drawer and a writing board is provided underneath the top. Top is mounted on sturdily built, well polished hard woods legs and frame, total height 31".



QUADRICEPS TABLE (with backrest)

A tubular frame with cushion top seat and back rest duly powder coated with force angle adjustment facility and torque assembly and weights.



T - PULLEY

Tubular constructed wall mounting unit, comes with two pulleys, cord and two handles used for exercise of the elbow and shoulder.



SUPINATION PRONATION SINGLE

A wall mounting device for single grip facility complete with a sensitive resistance control system for wrist exercise in supination / pronation, adjustable in height with celebrated drum to record the revaluation from either side.





India's Biggest Manufacturers of :
**MEDICAL SURGICAL
RUBBER PRODUCTS**



JULLUNDUR ENTERPRISES

(AN ISO 9001 : 2008 CERTIFIED COMPANY)

MEDICAL SURGICAL RUBBER PRODUCTS



KELLY DOUCHE PAD

- High quality rubber
- Comfortable to use
- Highly flexible



BED PAN RUBBER

- Specially made for the patients who cannot move themselves while sleeping and taking rest
- Soft touch feeling
- Comfort
- Washable



AIR CUSHION

- Available in Sizes :

30cm (12")	35cm (14")	40cm (16")
45cm (18")	50cm (20")	

MEDICAL SURGICAL RUBBER PRODUCTS



DOUCHE BAG / ENEMA BAG / IRRIGATOR SET

- Capacity: Approx.1.5 lit.
- Fitted with plastic connector
- Douche Tube
- Nozzle
- Clamp
- Hook



DOUCHE BAG / ENEMA BAG / IRRIGATOR

- Capacity: Approx.1.5 lit.
- Fitted with plastic connector



HOT WATER BOTTLE

Hot Water Bottle is available in

- Both Side Plain
- One Side Ribbed & One Side Plain
- Both Side Ribbed

Specifications : Leak proof & Seamless / Manufactured from first grade Natural Rubber only / Available in heat resistant Polypropylene screw-stopper or Metal Stopper with a rubber safety seal for preventing water leakage / Easy to fill.

MEDICAL SURGICAL RUBBER PRODUCTS



MACKINTOSH RUBBER CORRUGATED SHEET

- Regular grade to Premium grade material
- Easy to install & dismantle
- Minimal maintenance
- Long Durability
- Available in 1 meter piece and 10 meter rolls



RED RUBBER CATHETER

- Used for passage through body channels, chiefly for discharging fluid from cavity.
- Designed for passage through a peripheral blood vessel into the chambers of the heart, under roentgen logic control.
- Available in sizes 12 to 40
- Available in colour Red & Orange



STOMACH WASH TUBE

- Designed keeping in mind the needs of patients suffering from food poisoning cases
- Provides ease of gastric wash and to wash out the problem related to hyper acidity
- Non toxic
- Kink resistance

MEDICAL SURGICAL RUBBER PRODUCTS

ICE BAG



- Superior Quality made of cloth
- Easy to carry
- Relives sprains
- Suitable in high fever
- Recommended by doctors
- Durability

ICE BAG ROUND



- Easy to carry
- Relives sprains
- Suitable in high fever
- Recommended by doctors
- Durability

ICE BAG OVAL



- Easy to carry
- Relives sprains
- Suitable in high fever
- Recommended by doctors
- Durability

MEDICAL SURGICAL RUBBER PRODUCTS

RYLES TUBE

- Made of Non-toxic and non-irritant medical grade
- For Feeding and Sucking purpose
- Available in color Red
- Available in sizes 8 to 14 & 16 to 24

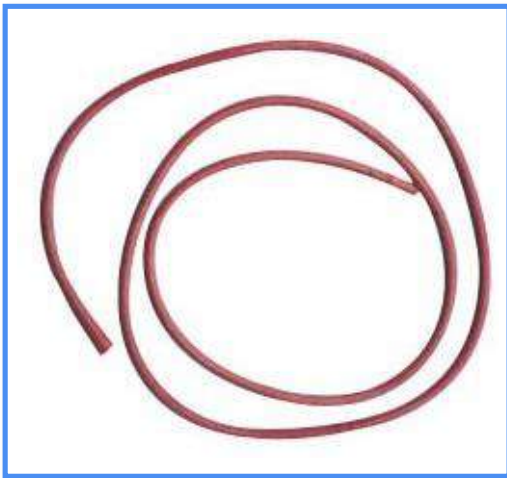

ENEMA SYRINGE

- Facilitate easy passing out of stool from patient's anus.
- Flexible
- Comfortable for the patient
- High tensile strength
- Leak proof
- Enema Syringe is available in two models

Jointed Model

Jointless Model



RECTAL TUBE

- Made from best quality rubber
- Available in Red color



MEDICAL SURGICAL RUBBER PRODUCTS



RING PESSARY

- Available in Red Rubber or White Silicon
- Sizes from 2 inches to 4 inches.
- Flexible
- High tensile strength
- Long lasting



ECG BULB / ECG BULB WITH ELECTRODE

- Available in Small, Medium, Large and Extra Large Sizes



PIPETTE BULB

- Available in Small, Medium & Large Sizes

MEDICAL SURGICAL RUBBER PRODUCTS

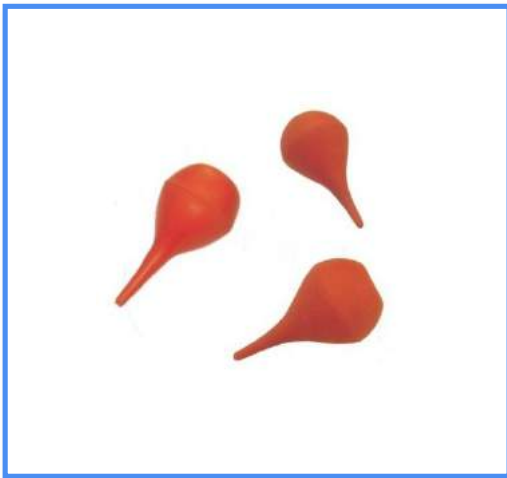

MUCUS SUCKER

- Available in different sizes :

1 oz	2 oz	3 oz
4 oz		



SINGLE AIR BELLOW

- Consistent usage
- Flexible
- Longer serviceability



HAND GLOVES RUBBER / RED RUBBER GLOVES

- Available in different sizes :

Size 7	Size 8	Size 9
--------	--------	--------

MEDICAL SURGICAL RUBBER PRODUCTS

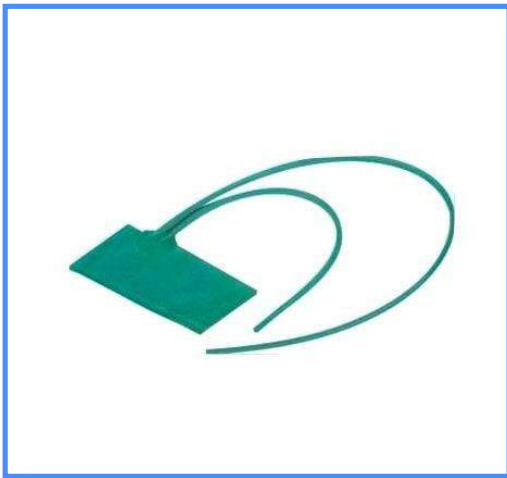

BP ARMLET / BLOOD PRESSURE ARMLET

- Available in different sizes for:

Large Thigh	Small Thigh	Adult Arm
Child Arm	Infant Arm	New Born Baby Arm



BP BULB

BP bulbs in two types of colors & Quality as enlisted below:

- Black
- Green



BREAST PUMP / RELIEVER

- Rubber bulb with glass bell

MEDICAL SURGICAL RUBBER PRODUCTS



ASEPTO SYRINGE / PLUNGERLESS SYRINGE

- Glass tube with catheter tip fitted with rubber bulb
- Available in different sizes :

1 oz	2 oz	3 oz
4 oz		



VAGINAL DOUCHE SPRAY

- Complete with plastic nozzle and rubber shield



LATEX FINGER COTS

- Available in different sizes :

Small	Medium	Large
Extra Large		

MEDICAL SURGICAL RUBBER PRODUCTS



SR CATHETER / SELF RETAINING CATHETER

- Designed for passage through a peripheral blood vessel into the chambers of the heart, under roentgen logic control.
- Constructed so that it remains in the bladder, effecting constant drainage.
- Available in sizes 12 to 40
- Available in colour Red & Orange

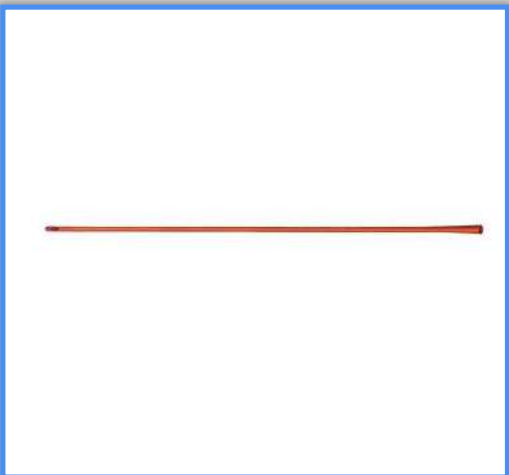

NELATON RUBBER CATHETER

- Available in lenth 38 cm to 40 cm
- Available in Fr 8 to Fr 26



CHLOROFORM SIGMOIDOSCOPE BELLOWS / INHALER

- Available in 500ml & 1000ml

MEDICAL /NURSING MODELS & CHARTS

CATALOGUE : 2018-2019

IMPORTED MANIKINS, SIMULATORS, MODELS & CHARTS OF

- SKELETON ■ TORSO ■ JOINTS ■ DIGESTIVE
- HEART ■ BRAIN ■ RESCUE EMERGENCY MANIKIN
- EAR, NOSE & THROAT ■ CPR MANIKIN
- LIFE SUPPORT TRAINING
- TRAUMA MANIKIN
- MEDICAL NURSING TRAINING
- PARAMEDICAL MODELS
- PHARMACY CHARTS & MODELS
- AED TRAINER
- SURGICAL NURSING TRAINING
- OBSTETRICS, GYNECOLOGY & MIDWIFERY TRAINING
- NEONATAL /PEDIATRIC NURSING TRAINING
- MEDICAL EXAMINATION TRAINING
- FIELD EMERGENCY TRAINING
- STOMATOLOGY /DENTAL TRAINING
- TRACHEOTOMY CARE SIMULATOR
- GASTRONOMY CARE SIMULATOR
- TUBE FEEDING TRAINING
- IV INJECTION TRAINING
- NEW BORN RESUSCITATION
- COMMUNITY HEALTH BAGS
- CHARTS & SIMULATORS etc.

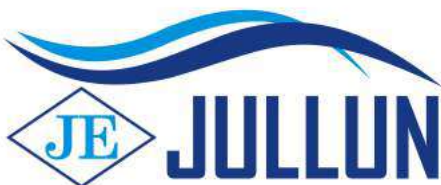
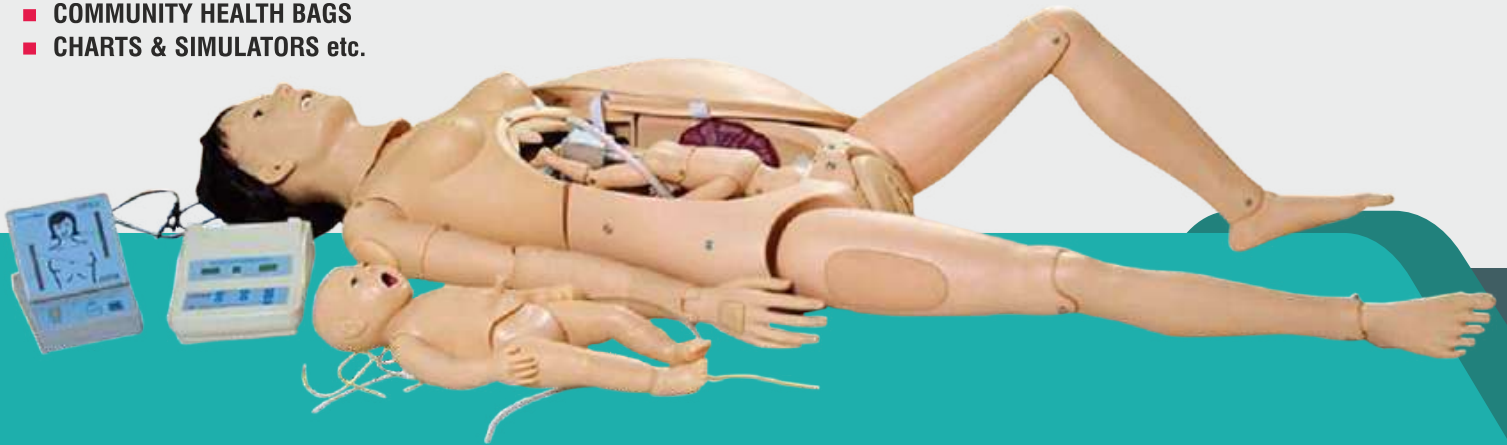
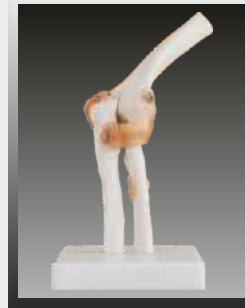
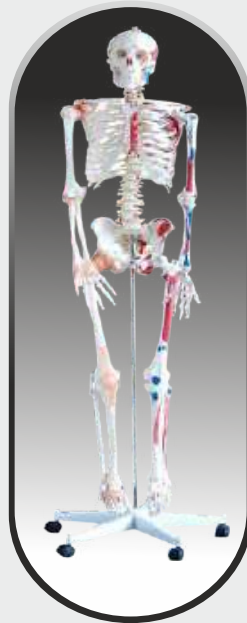

JULLUNDUR ENTERPRISES

1568-A, G-22-23, BHAGIRATH PALACE
DELHI 110006, INDIA

+91 9871432046 / +91 9999329288
INFO@JEMEDIGUARD.COM
WWW.JEMEDIGUARD.COM

VISUAL MEDICAL CHARTS

Printed on water proof reinforced PVC Sheeting (REXINE)

HUMAN ANATOMY CHARTS

Size 90x60cms FITTED WITH ROLLERS

Size 90x60cms WITH HARD BACKING & ALUMINIUM FRAME

each chart

each chart

- HA 1 Human: Skeleton
- HA 2 Human: Skeleton Joints and Limbs
- HA 3 Human: Heart
- HA 4 Human: Arterial System
- HA 5 Human: Venous System
- HA 6 Human: Digestive System
- HA 7 Human: Respiratory System
- HA 8 Human: Excretory System
- HA 9 Human: Brain
- HA 10 Human: Spinal Cord
- HA 11 Human: Skin
- HA 12 Human: Ear
- HA 13 Human: Eye
- HA 14 Human: Endocrine Glands
- HA 15 Human: Reproductive System
- HA 16 Human: Nervous System
- HA 17 Human: Muscular System
- HA 18 Human: Nose
- HA 19 Human: Tongue
- HA 20 Human: Muscles
- HA 21 Human: Cartilage & Bone
- HA 22 Human: Blood
- HA 23 Human: Blood Groups
- HA 24 Human: Embryo Development I
- HA 25 Human: Embryo Development II
- HA 26 Human: Lymphatic System
- HA 27 Human: Teeth
- HA 28 Human: Menstrual Cycle
- HA 29 Human: Immunity System
- HA 30 Human: Body
- HA 31 Human: Ovum
- HA 32 Human: Vascular System and Viscera
- HA 33 Human: Blood-I (R.B.C.)
- HA 34 Human: Blood-II (W.B.C.)
- HA 35 Human: Sperm
- HA 36 Human: Sense Organs
- HA 37 Human: Neuron
- HA 38 Human: Nephron
- HA 39 Human: Endocrine Glands: Function
- HA 40 Human: Liver & Pancreas
- HA 41 Human: Circulatory System
- HA 42 Human: Anatomy
- HA 43 Human: Reproductive System (Male)
- HA 44 Human: Stomach
- HA 45 Human: Reproductive System (Female)
- HA 46 Vestigial Organs in Human Being
- HA 47 Human: Ultra Structure of Human Cell
- HA 48 Human: Large Intestine
- HA 49 Human: Skull System
- HA 50 Human: Mammary Gland
- HA 51 Human: Karyogram
- HA 52 Human: Small Intestine
- HA 53 Human: Pitutary Gland
- HA 54 Human: Thyroid Gland
- HA 55 Human: Lymph Nods
- HA 56 Human: Adrenal Gland
- HA 57 Human: Pelvis Anatomy

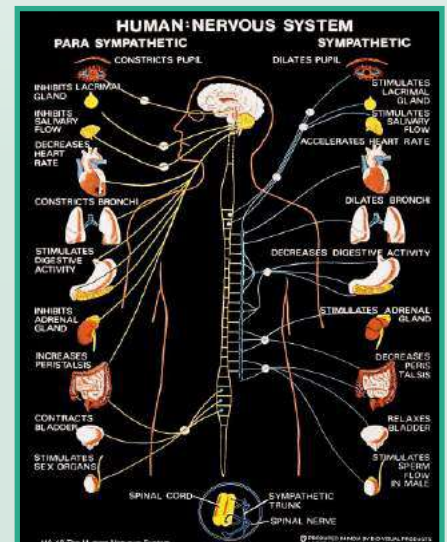
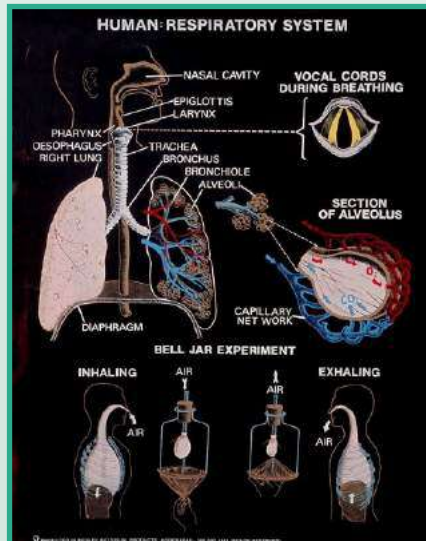
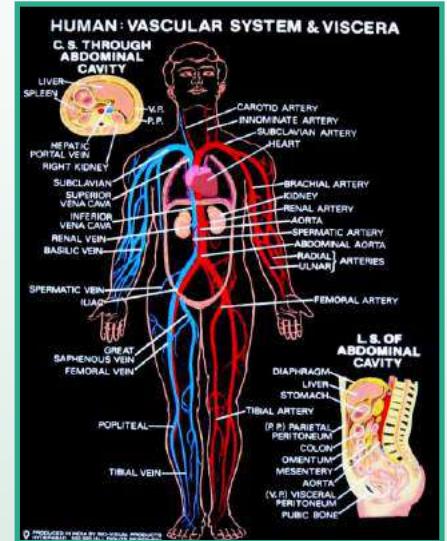
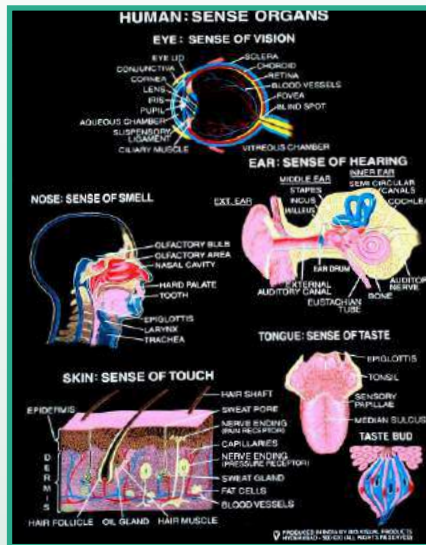
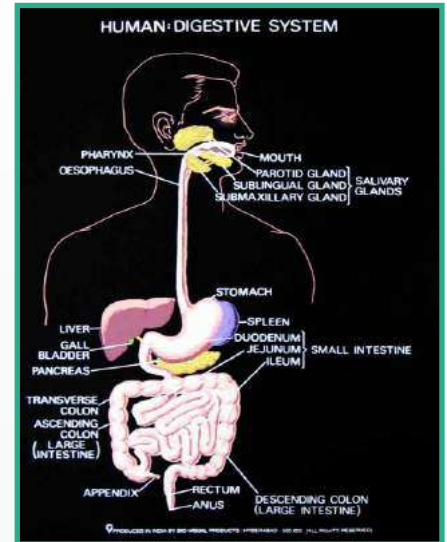
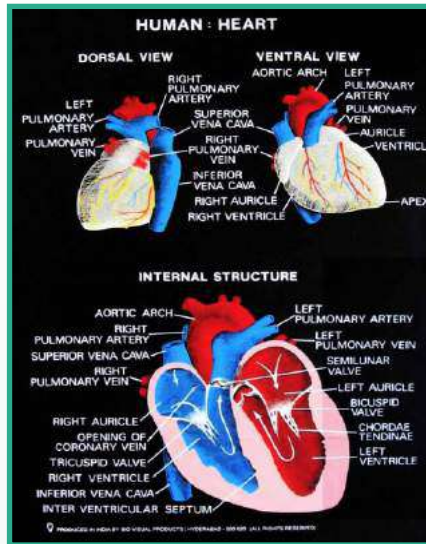

VISUAL MEDICAL CHARTS

Printed on water proof reinforced PVC Sheeting (REXINE)

HEALTH AWARENESS CHARTS

Size 100x125cms FITTED WITH ROLLERS

each chart

Size 100x125cms WITH HARD BACKING & ALUMINIUM FRAME

each chart

- Bi 92** Self Breast Examination
- Bi 93** Harmful Effects of Alcohol
- Bi 94** Harmful Effects of Tobacco Smoking
- Bi 95** Harmful Effects of Steroids
- Bi 96** Sexually Transmitted Infections
- Bi 97** Communicable Diseases
- Bi 98** Food Safty

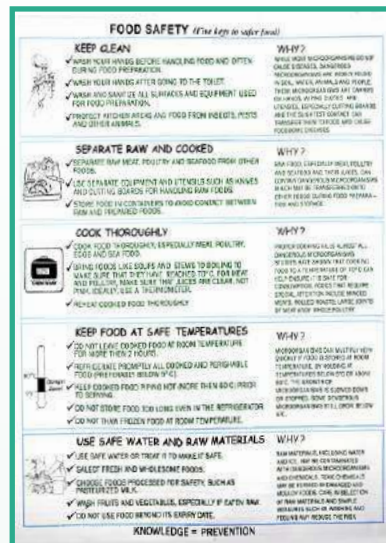
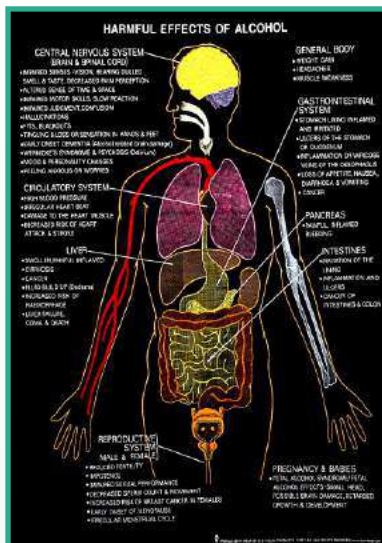

PHARMACOLOGY CHARTS

Size 100x125cms FITTED WITH ROLLERS

each chart

Size 100x125cms WITH HARD BACKING & ALUMINIUM FRAME

each chart

- Bi 137** Immunoglobulin Structure
- Bi 170** Drug Acting on Nervous System
- Bi 171** Immunopathology
- Bi 172** Pharmacokinetics-I
- Bi 173** Pharmacokinetics-II
- Bi 174** Cell Medicated Immune Reaction: Cytokines
- Bi 175** Vascular Path Way or Drug
- Bi 176** Development of Immune System
- Bi 177** Antiparastic agents
- Bi 178** Lytic and Lysogenic Cycle
- Bi 179** Antifungal Agent
- Bi 180** Emetics Antiemetics & Gastrointestinal Drug
- Bi 181** Insulin Drugs
- Bi 182** Lymphoid organs and Diseases
- Bi 183** Auto Immune Diseases
- Bi 184** Pharmaceutical Evaporator-I
- Bi 185** Pharmaceutical Evaporator-II
- Bi 186** Compression Process or Table
- Bi 187** Drug Packaging System
- Bi 188** Centrifugation
- Bi 189** Extraction
- Bi 190** Drying
- Bi 191** Distillation (Molecular)
- Bi 192** Thyroid Hormones & Thyroid Inhibitors
- Bi 193** Local Anaesthetics
- Bi 194** Effect of Lithium
- Bi 195** Action of Benzodiazepines
- Bi 196** Angina Pectoris
- Bi 197** Filtration-I
- Bi 198** Filtration-II
- Bi 199** Antiviral Drugs
- Bi 200** Skeletal Music Relaxants
- Bi 201** Antiepileptic drugs
- Bi 202** Antiparkinsonian Drugs
- Bi 203** Antidepressant and antimatic Drug
- Bi 204** Antiarrhythmic Drug
- Bi 205** Anticancer Drugs
- Bi 206** Physiology of Urine Formation

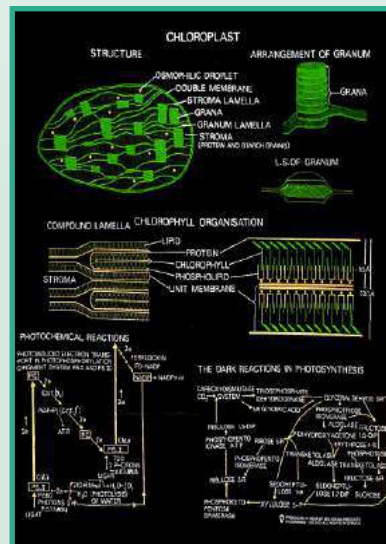
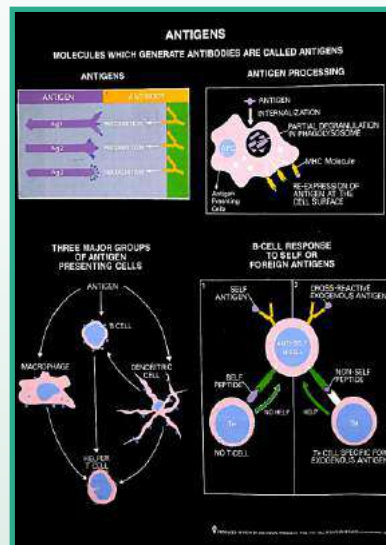
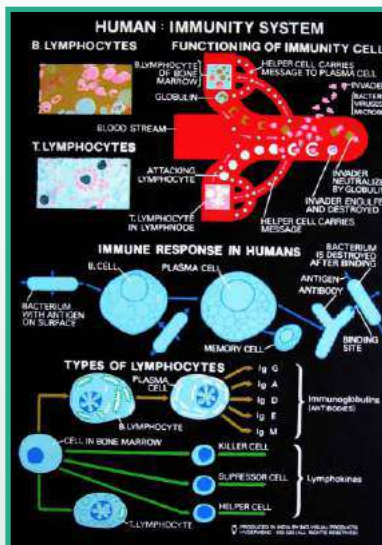

BIOCHEMISTRY CHARTS

Size 100x125cms FITTED WITH ROLLERS

Size 100x125cms WITH HARD BACKING & ALUMINIUM FRAME

each chart

each chart

- Bi 83 Protein Structure
- Bi 121 Diabetes: Glucose Estimation
- Bi 122 Heart Attack: Cholesterol Estimation
- Bi 118 Balanced Diet
- Bi 123 Jaundice: Bilirubin Estimation
- Bi 157 Gene Transfer I-Conjugation
- Bi 158 Gene Transfer II-Tansduction
- Bi 159 Gene Transfer III- Transformation
- B 176 C4 & CAM Cycles
- C 10 Alpha helical Structure of a polypeptide
- C 11 Tertiary & Quarternary Structure of Protein
- C 40 Amino Acids: Structure & Classification
- Bi 09 Cell Membranes & Cell wall
- Bi 10 Endoplasmic Reticulum
- Bi 11 Mitochondrion
- Bi 12 Golgi Complex
- Bi 13 Chloroplast
- Bi 14 Nucleus
- Bi 15 Chromosomes
- Bi 18 DNA 8 Loops (7'x3')
- Bi 19 DNA Structure (Compounds)
- Bi 26 RNA Types: Transcription & Translation
- Bi 27 RNA Structure
- Bi 28 Protein Synthesis
- Bi 29 Urea Cycle
- Bi 30 Vitamins: Sources & Deficiency
- Bi 55 Osmosis, Plasmolysis & Diffusion
- Bi 56 Gluconeogenesis & HMP Pathway
- Bi 58 Enzymes: Classification & Kinetics
- Bi 60 Genetic Code
- Bi 66 Chromatography
- Bi 67 Electrophoresis
- Bi 80 Ribosomes & Lysosomes
- Bi 81 Active & Passive Transport
- Bi 82 Fatty Acid Oxidation & Regulation
- Bi 84 Nucleotides & Biosynthesis
- Bi 86 Prokaryotic & Eukaryotic Cells
- Bi 111 Marasmus & Kwashiorkor
- Bi 128 Lac Operon
- Bi 129 Recombinant DNA & Cloning
- Bi 130 Monoclonal Antibodies & Bottling
- Bi 134 Tryptophan Operon
- Bi 135 Arabionose Operon
- Bi 136 Total Count of Blood
- Bi 137 Polymerase Chain Reaction
- Bi 138 Antigen-antibody Interaction-I
- Bi 139 Antigen-antibody Interaction-II
- Bi 140 Polymerase Chain Reaction
- Bi 141 Plasma Membrane
- Bi 142 Manufacture of alcohol from Molasses
- Bi 145 Hypersensitivity Type -I
- Bi 146 Blotting techniques for nucleic acid
- Bi 149 Life Cycle: Human Immunodeficiency virus
- Bi 152 Bacteria
- Bi 153 Blotting Technique for Protein
- Bi 154 Laboratory Safety
- Bi 155 Forms of D.N.A.

- Bi 156 Transposons
- Bi 161 DNA Replication Types
- Bi 163 DNA Viral Replication
- Bi 164 Major Histocompatibility Class I Molecule
- Bi 165 Major Histocompatibility Class II Molecule
- Bi 167 Electron Microscope
- Bi 168 Complement System
- Bi 169 Kerb's Cycle
- B 153 Viruses
- B 196 Plant Tissue Culture
- B 194 Plant Respiration
- B 199 Plant Hormones
- B 231 Mucor
- B 232 Mucor : Life Cycle
- C 009 DNA Structure & Replication

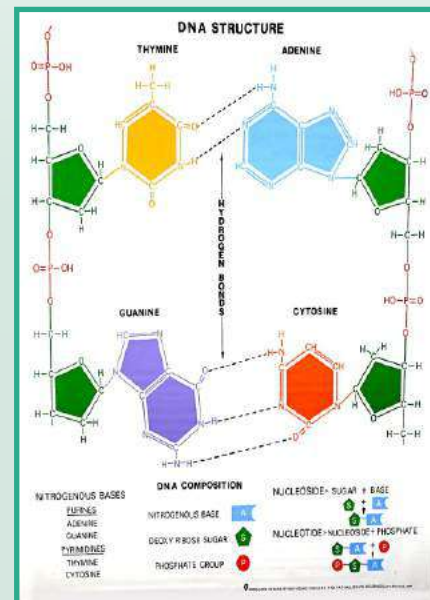
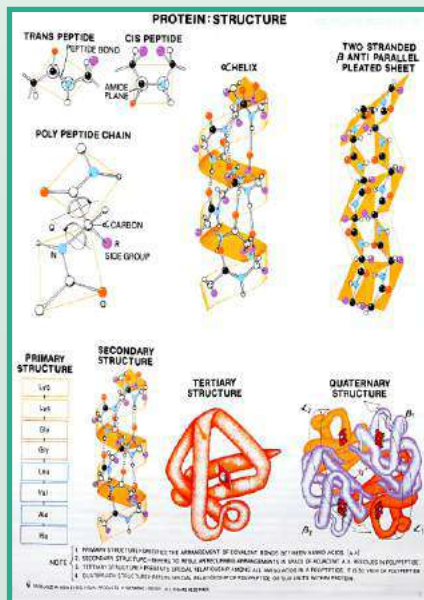
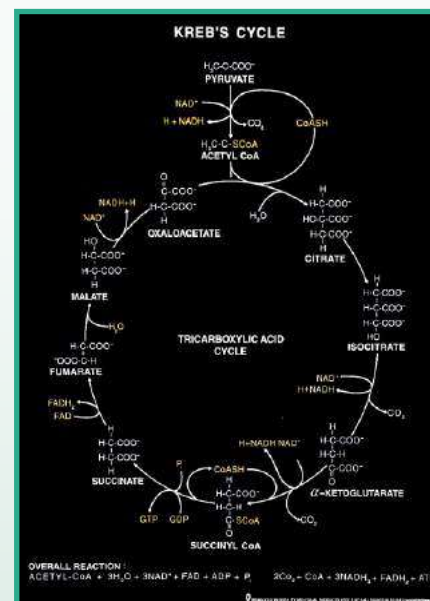
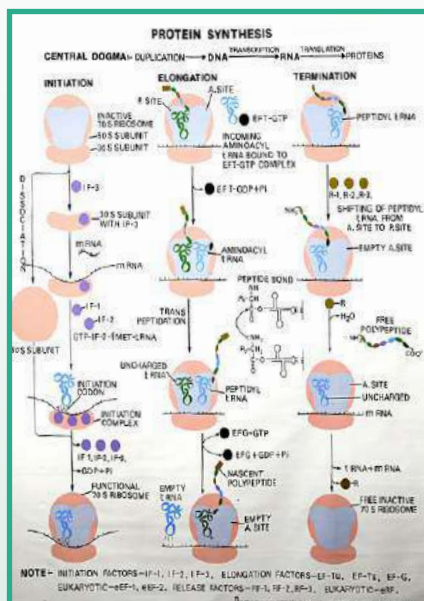

MATERNAL AND CHILD HEALTH NURSING LAB. CHARTS

SIZE 60x45 cm. approx

CHART CODE NO. NAME OF THE CHART

- ANM01 Breast Changes in Pregnancy
- ANM02 Uterine Changes in Pregnancy
- ANM03 First Stage of Labour
- ANM04 Second Stage labour
- ANM05 Third Stage labour
- ANM06 Complete Breech Presentation
- ANM07 Incomplete Breech Presentation
- ANM08 Foot Presentation
- ANM09 Shoulder Presentation
- ANM10 Face Presentation
- ANM11 Brow Presentation
- ANM12 Twin Pregnancy
- ANM13 Placenta Praevia
- ANM14 Caput Succedaneum, Cephalhaematoma
- ANM15 Congenital Malformation of New Born
- ANM16 Cleft lip-Palate
- ANM17 Spina Bifida
- ANM18 Hydrocephalus
- ANM19 Anencephalus
- ANM20 Breast Self Examination

Matt Canvas Laminated with Frame on Board

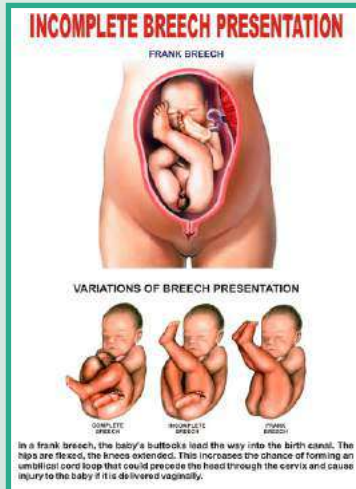
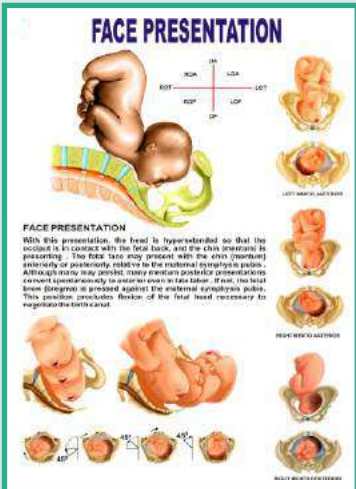
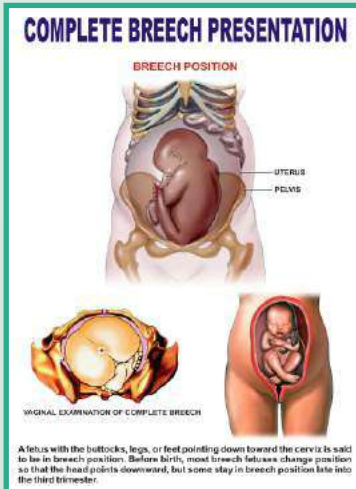
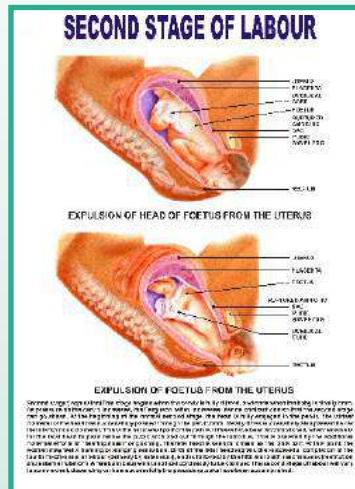
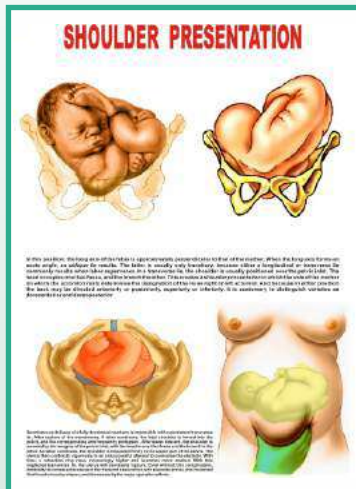
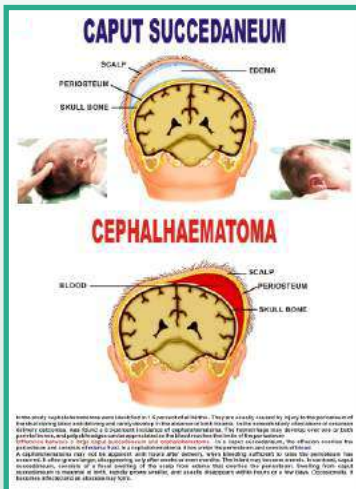
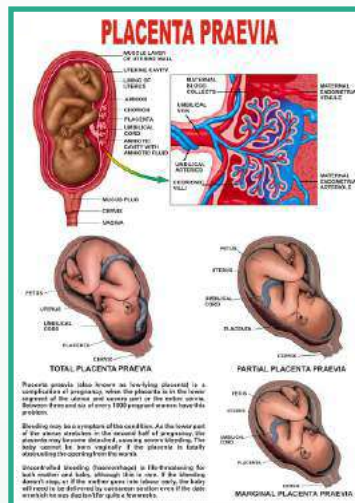
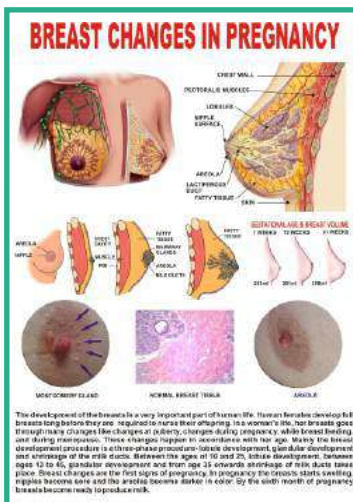



3D EMBOSSED THE WORLD'S BEST ANATOMICAL CHARTS (MADE IN U.S.A.)

Published by Anatomical Chart Co. (U.S.A.) /WOLTERS KLUWER complete with hard backing, aluminium frame & hanging hooks Size 51x66cm

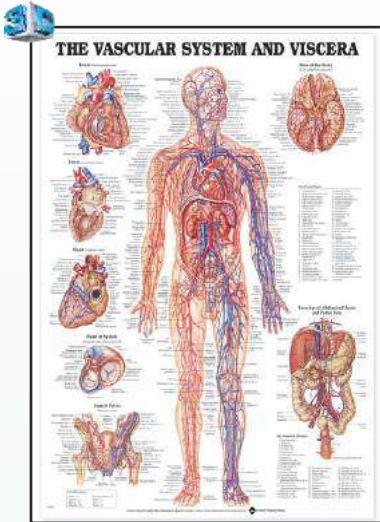

- D3-01** THE VASCULAR SYSTEM AND VISCERA
- D3-02** UNDERSTANDING OSTEOPOROSIS
- D3-03** UNDERSTANDING THE COMMON COLD
- D3-04** UNDERSTANDING EPILEPSY
- D3-05** DERMATOMES
- D3-06** THE PROSTATE
- D3-07** HUMAN SPINE DISORDERS
- D3-08** KNEE INJURIES
- D3-09** HIP AND KNEE
- D3-10** HAND AND WRIST
- D3-11** FOOT AND ANKLE
- D3-12** U/S CARPAL TUNNEL SYNDROME

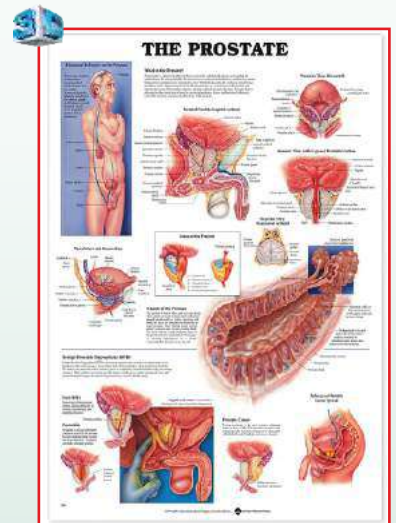
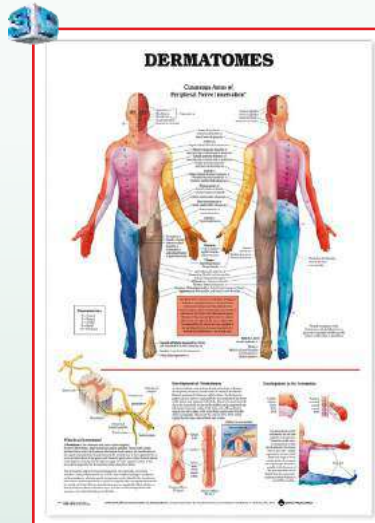
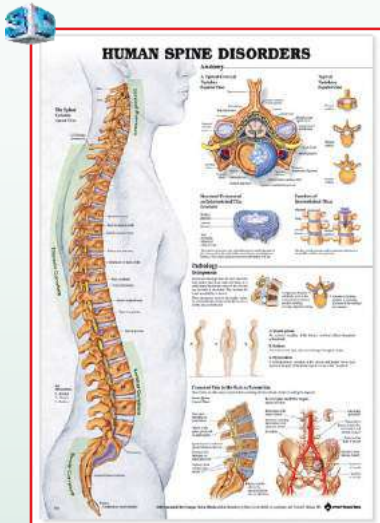
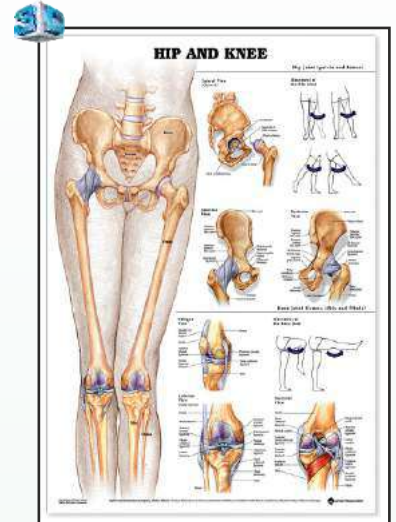

New

GD/FT5 NEWBORN BABY DOLLS (Set of 4)

GD/FT1 Term fetus

Size: 52.5x27x15.5cm

G.W. : 2.7kg

GD/FT2 Newborn baby with visible umbilical cord

Size: 52.5x27x15.5cm

G.W. : 2.5kg

GD/FT3 Newborn baby without umbilical cord

G.W. : 1.5kg

GD/FT4 One-month baby

Size: 52.5x27x15.5cm

G.W. 1.5kg



THE WORLD'S BEST ANATOMICAL CHARTS (MADE IN U.S.A.)

Published by Anatomical Chart Co. (U.S.A.)

These Charts are published by World's Best Anatomical Chart Co., U.S.A. which are perfect for everybody in the Medical /Nursing profession. These Charts shows the maximum Anatomical details which are visible at a glance, all the Anatomical features are clearly labeled to avoid any confusion, striking colorful images for capturing immediate attention. All the key organs and structures are shown in enlarged view with the best possible Anatomical details. These are in size 51x66cm approx.

With special rigid lamination on board with aluminium frame & hanging hooks

With special rigid lamination with plastic rollers

SKELETON SYSTEM CHARTS

- DA001** The Skeletal System
- DA002** The Vertebral Column
- DA003** Human Spine Disorders
- DA004** The Human Skull
- DA005** Hand And Wrist
- DA006** Understanding Carpal Tunnel Syndrome
- DA007** Shoulder And Elbow
- DA008** Head And Neck
- DA009** Hip And Knee
- DA010** Whiplash Injuries Of The Head & Neck
- DA011** The Muscular System
- DA012** Low Back Pain
- DA013** Ligaments Of The Joints
- DA014** Understanding Arthritis
- DA015** Anatomy & Injuries Of The Hand & Wrist
- DA016** Anatomy & Injuries Of The Shoulder
- DA017** Anatomy & Injuries Of The Hip
- DA018** Anatomy & Injuries Of The Spine
- DA019** U/S Joint Lower Extremities
- DA020** U/S Upper Extremities
- DA021** U/S Athletic Injuries of Knee
- DA022** Anatomy & Injuries of the Foot & Ankle
- DA023** Foot & Ankle
- DA024** Hip and Knee Inflammations
- DA025** Knee Injuries
- DA026** Temporomandibular Joint (TMJ)
- DA027** Understanding Pain
- DA028** Human Spine Disorders
- DA029** Understanding Arthritis

TEETH & JAW

- DA030** Disorder of Teeth and Jaw
- DA031** Anatomy of teeth

WEIGHT AND DIET

- DA032** Keys to Healthy Eating
- DA033** Maintaining a Healthy
- DA034** Weight Metabolic Syndrome
- DA035** Risks of Obesity
- DA036** BMI & Waist Circumference

HEART AND CIRCULATORY SYSTEM

- DA037** Anatomy of the Heart
- DA038** Cardiovascular Disease
- DA039** Deep Vein Thrombosis

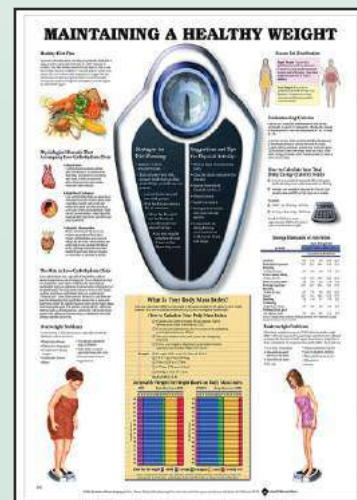
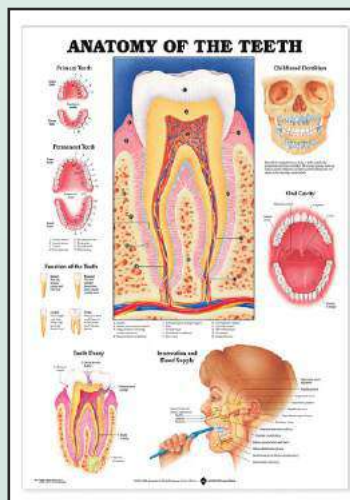
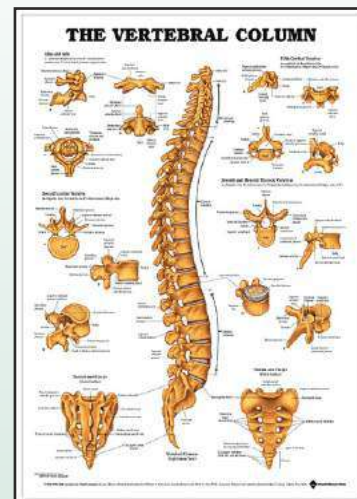
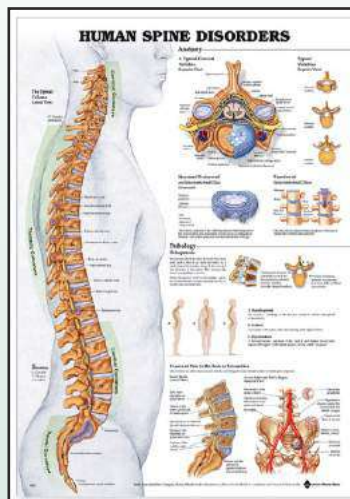
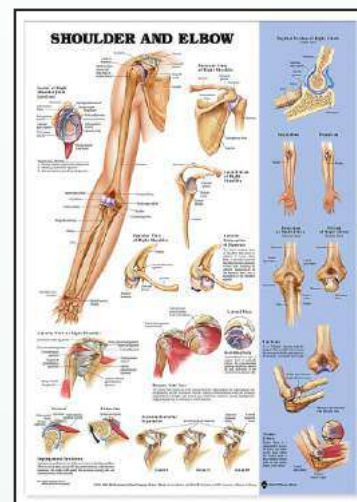

THE WORLD'S BEST ANATOMICAL CHARTS (MADE IN U.S.A.)

Published by Anatomical Chart Co. (U.S.A.)

These Charts are published by World's Best Anatomical Chart Co., U.S.A. which are perfect for everybody in the Medical /Nursing profession. These Charts shows the maximum Anatomical details which are visible at a glance, all the Anatomical features are clearly labeled to avoid any confusion, striking colorful images for capturing immediate attention. All the key organs and structures are shown in enlarged view with the best possible Anatomical details. These are in size 51x66cm approx.

With special rigid lamination on board with aluminium frame & hanging hooks

With special rigid lamination with plastic rollers

- DA040** Heart Conditions
- DA041** Heart Disease
- DA042** Hypertension
- DA043** The Heart
- DA044** The Vascular System and Viscera
- DA045** Understanding Cholesterol
- DA046** Understanding Hypertension

NERVOUS SYSTEM

- DA047** Anatomy of the Brain
- DA048** Autonomic Nervous System
- DA049** Dermatomes
- DA050** Migraines and Headaches
- DA051** The Brain
- DA052** The Nervous System
- DA053** The Spinal Nerves
- DA054** Understanding Alzheimer's
- DA055** Understanding Depressions
- DA056** Understanding Epilepsy
- DA057** Understanding Multiple Sclerosis
- DA058** Understanding Parkinson's Disease
- DA059** The Lymphatic System
- DA060** Understanding Stroke
- DA061** Understanding Schizophrenia

DIABETES

- DA062** Understanding Diabetes
- DA063** Understanding Diabetes Type 1
- DA064** Understanding Diabetes Type 2
- DA065** The Kidney

GYNECOLOGY & REPRODUCTIVE SYSTEM

- DA066** The Prostate
- DA067** Understanding Erectile Dysfunction
- DA068** The Female Muscular System
- DA069** Pregnancy in Birth

HIV AND AIDS

- DA070** Understanding HIV and AIDS
- DA071** Sexually Transmitted Infections

THE ENDOCRINE SYSTEM

- DA072** The Endocrine System
- DA073** The Thyroid Disorder
- DA074** Internal Organs of the Human Body

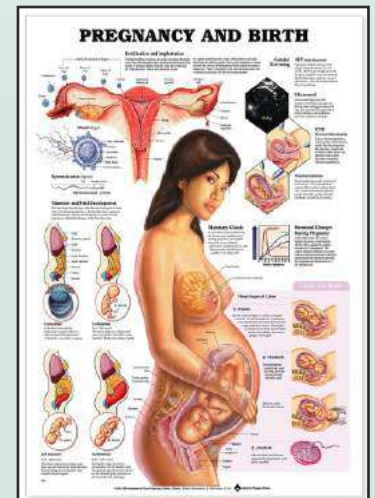
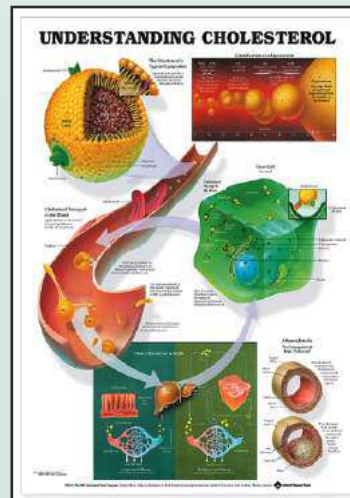
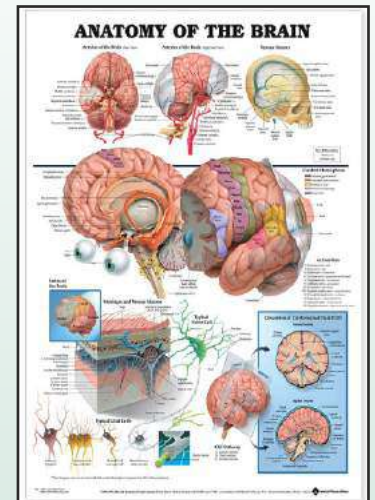
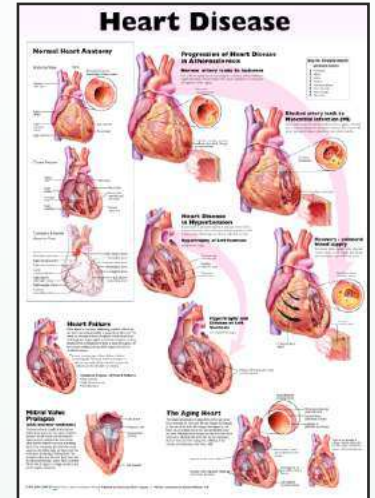
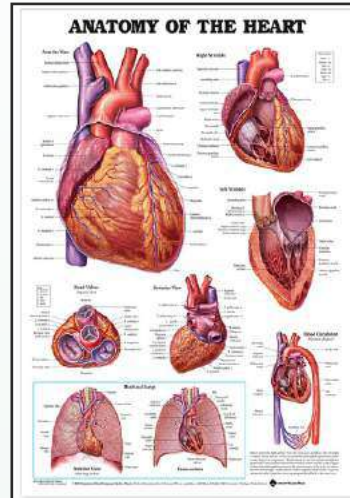

THE WORLD'S BEST ANATOMICAL CHARTS (MADE IN U.S.A.)

Published by Anatomical Chart Co. (U.S.A.)

These Charts are published by World's Best Anatomical Chart Co., U.S.A. which are perfect for everybody in the Medical /Nursing profession. These Charts shows the maximum Anatomical details which are visible at a glance, all the Anatomical features are clearly labeled to avoid any confusion, striking colorful images for capturing immediate attention. All the key organs and structures are shown in enlarged view with the best possible Anatomical details. These are in size 51x66cm approx.

With special rigid lamination on board with aluminium frame & hanging hooks

With special rigid lamination with plastic rollers

THE RESPIRATORY SYSTEM

- DA075** The Respiratory System
- DA076** The Respiratory System and Asthma
- DA077** Understanding Asthma
- DA078** Understanding Allergies
- DA079** Understanding Bacterial Infections
- DA080** Understanding Influenza
- DA081** Understanding the Common Cold
- DA082** Understanding Viral Infections
- DA083** Chronic Obstructive pulmonary Diseases

IMMUNE SYSTEM

- DA084** Understanding Osteoporosis
- DA085** Understanding Skin Cancer
- DA086** Understanding Ulcer
- DA087** Understanding Menopauses
- DA088** Understanding Cancer
- DA089** Dangers of Alcohol
- DA090** Dangers of Smoking
- DA091** Understanding Hepatitis
- DA092** Understanding Breast Disease
- DA093** Understanding Viral Infection
- DA094** Understanding Glaucoma

EYE, EAR, NOSE & THROAT

- DA095** The Eye
- DA096** Disorder of the Eye
- DA097** The Human Hair
- DA098** Ear, Nose & Throat
- DA099** Middle Ear Condition
- DA100** Anatomy of the Inner Ear
- DA101** The Eye Anterior & Proterior Chamber

SYSTEMS OF HUMAN BODY

- DA102** The Skeletal System
- DA103** The Muscular System
- DA104** Vascular System and Viscera
- DA105** Autonomic Nervous System
- DA106** The Nervous System
- DA107** The Female Muscular System
- DA108** The Lymphatic System
- DA109** The Endocrine System
- DA110** The Respiratory System

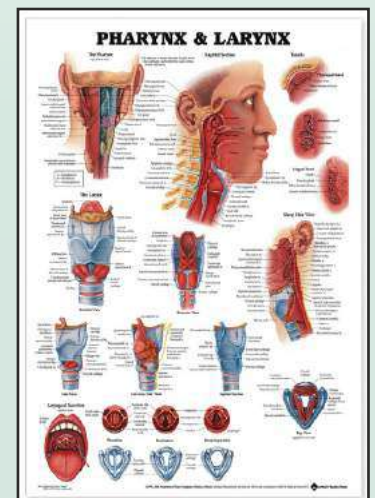
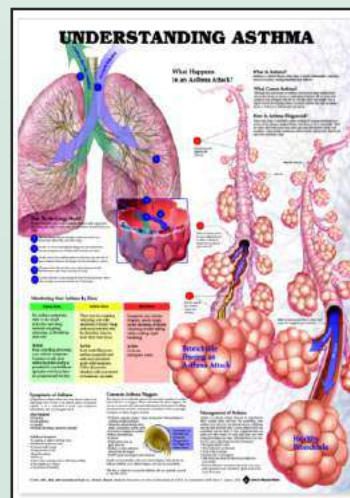
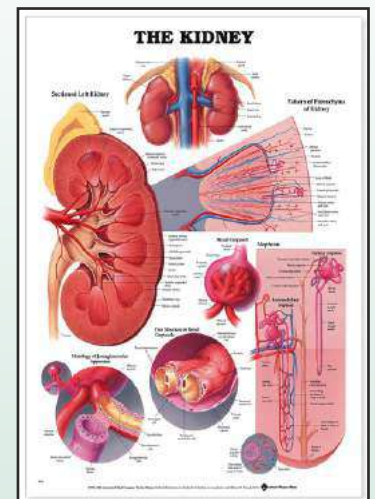
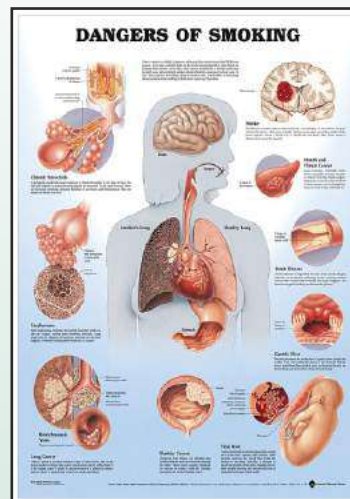
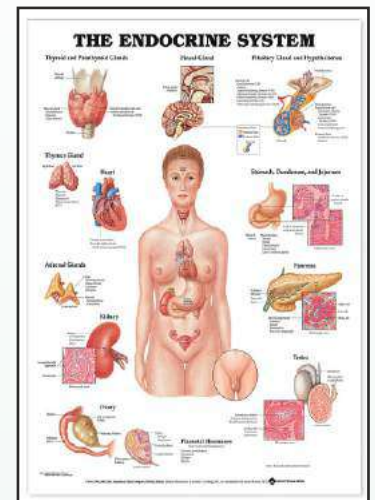
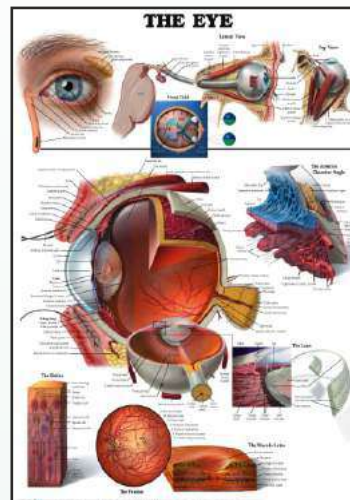

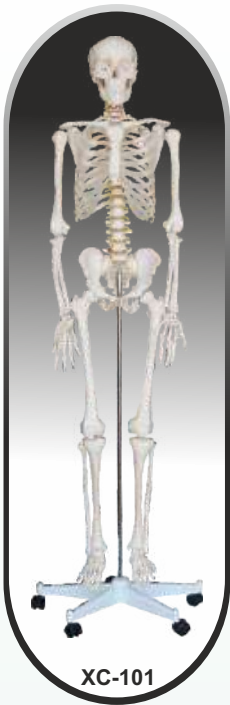

XC-101

XC-101
HUMAN SKELETON MALE LIFE SIZE (TALL 180 cms)

GD/A11101 HUMAN SKELETON FEMALE LIFE SIZE (TALL 162 cms)

Life size articulated adult plastic skeleton is ideal for teaching the basics of human anatomy. The arms and legs are removable for study. Features nerve branches. Vertebral artery and herniated lumbar disc. Skull includes removable lower teeth. Mounted on a calvarium, suture lines and 3 removable lower teeth. Mounted on a sturdy 16" wide base. Made of washable wand unbreakable PVC plastic.

XC - 102
HUMAN SKELETON MEDIUM (TALL 85 cms)

Skeleton with full natural movement and a user-friendly personality that will encourage children to learn the names of the bones, with details to satisfy students, doctors or anyone interested in the human skeleton. Removable calvarium. Mounted on an iron metal stand. Made of washable and unbreakable PVC plastic.

XC - 102B
HUMAN SKELETON WITH NERVES & BLOOD VESSELS (TALL 85 cms)

This model depicts the position, course and distribution of main arteries and peripheral nerves of the human body. It may be employed as a visual aid in the instruction of anatomy to students of medicine. Mounted on an iron metal stand. Made of washable and unbreakable PVC plastic.

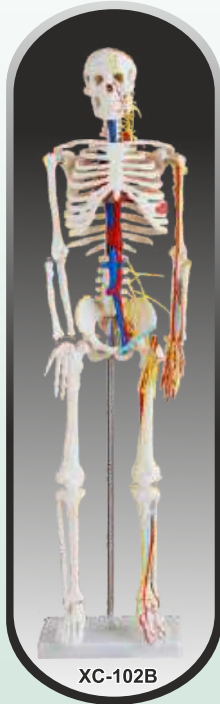

XC-102B

XC-130-C New
DISARTICULATED HUMAN SKELETON (UNILATERAL)
 (100 Bone Set) Same as XC-130 but with single side set of bones with full skull.

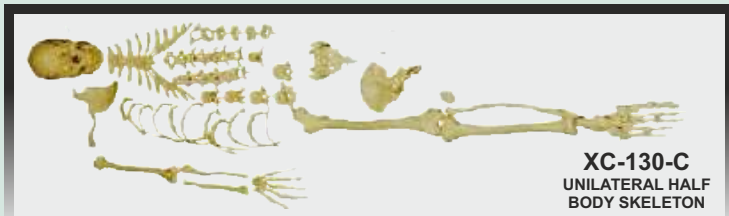

XC-130-C
 UNILATERAL HALF BODY SKELETON

XC-101A
HUMAN SKELETON MALE WITH MUSCLES & LIGAMENTS LIFE - SIZE (TALL 180 cms)

Life size articulated adult plastic skeleton is ideal for teaching the basics of human anatomy. The arms and legs are removable for study. Features nerve branches. Vertebral artery and herniated lumbar disc. Skull includes removable lower teeth. Mounted on a calvarium, suture lines and 3 removable lower teeth. Mounted on a sturdy 16" wide base. Made of washable and unbreakable PVC plastic.

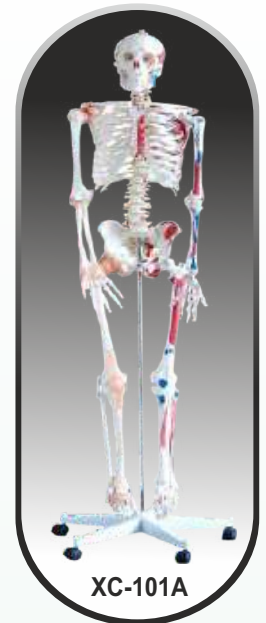

XC-101A

XC - 130
DISARTICULATED HUMAN SKELETON (BILATERAL) (200 Bones) Bone set

Life size disarticulated skeleton will encourage students to learn various bones of an Adult Human. It is a visual aid for instruction of anatomy for students, doctors, nurses or anyone interested in human skeleton.

XC-130-B
DISARTICULATED HUMAN SKELETON (200 BONES) Bone set (BILATERAL)

This Model is exactly same as XC-130 above but the bones are coloured by hand to show the muscles.

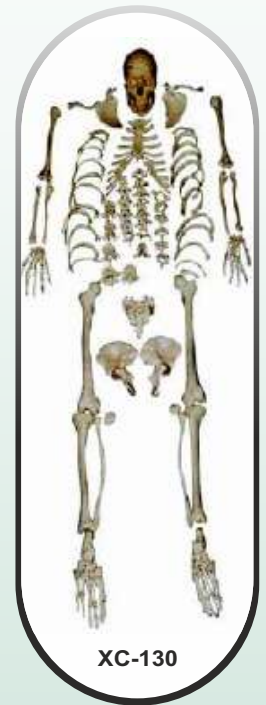

XC-130



XC-130B

IMPORTED SKELETON MODELS



XC - 109 **SHOULDER JOINT LIFE SIZE WITH MUSCLES**

An instructional model to illustrate abduction, anteversion, retroversion and internal/external rotation. Includes flexible , artificial ligaments. Made of PVC plastic. On Stand.

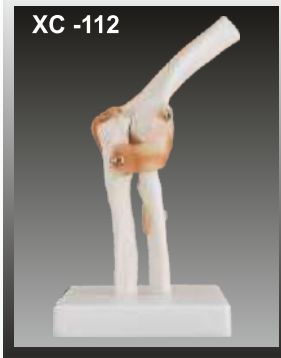

XC - 112 **ELBOW JOINT LIFE SIZE WITH MUSCLES**

Demonstrates flexion, extension and internal/external rotation of the radius. Include flexible, artificial ligaments. Made of PVC plastic. On Stand.



XC - 111 **KNEE JOINT LIFE SIZE WITH MUSCLES**

Demonstrates flexion, extension and internal/external rotation. Include flexible, artificial ligaments. Made of PVC plastic. On Stand.



XC-113A **FOOT JOINT WITH LIGAMENTS LIFE SIZE**

Demonstrate all of foot functionality and the external anatomical structures. Including flexible, artificial ligaments. Made of PVC plastic.

XC-114A **HAND JOINT WITH LIGAMENTS LIFE SIZE**

Demonstrate all of hand functionality and the external anatomical structures. Including flexible, artificial ligaments. Made of PVC plastic.



XD-127 **FUNCTIONAL ELBOW JOINT LIFE SIZE**

Life size. Shows the shapes and correct origins and insertions of biceps & triceps. Biceps and triceps are made of flexible material, extension and flexion can be shown as well as the antagonist relationship of these two muscles. On base.

XC - 114 **HAND JOINT LIFE SIZE**

Demonstrates all of hand functionality and the external anatomical structures. Made of PVC plastic. On Stand.

XC - 110 **HIP JOINT LIFE SIZE WITH MUSCLES**

Demonstrates anteversion, retroversion, abduction and internal/external rotation. Include flexible, artificial ligaments. Made of PVC plastic. On Stand.



XD - 118 **KNEE FUNCTIONAL JOINT LIFE SIZE WITH MUSCLES**

An instructional model to illustrate the ligament connections. Fully flexible joint to demonstrate abduction, anteversion, retroversion and internal/external rotation.. Made of PVC plastic. On Stand.

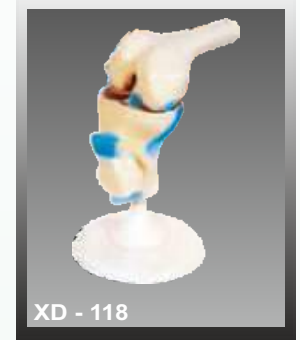

XC - 113 **FOOT JOINT LIFE SIZE**

Demonstrates all of foot functionality and the external anatomical structures. Made of PVC plastic. On stand.





XC -125

XC - 125 FEMALE PELVIC MUSCLES & ORGANS

This model is designed as an aid to the teaching of anatomy of female pelvis in institutes. It facilitates the students to get an integral knowledge of various important structures, such as pelvic muscles and pelvic organs as a whole. This model is made of PVC plastic. Natural size.



XC-123

XC - 123 ADULT MALE PELVIS

XC - 124 ADULT FEMALE PELVIS

These Models size are just the same as in realities and made of PVC plastic. Comparing a model of male pelvis with a female one, the differences between the two can be listed as followings:-

	Male	Female
Pelvis shapes	: Longs and narrow	Short and broad
Pelvis cava	: Like a funnel	Like a barrel
Aperture pelvis superiors	: Heart-like	Rounded
Sacrum	: Long and narrow	Broad and short
Angles of pelvis arch	: 70-75 degree	90-100 degree
Symphysis pubica	: Long and narrow	Short and broad



XC-124



XC -127

XC-127 BIRTH DEMONSTRATION MODEL

This model consists of 2 innominate bones, sacrum, coccyx, with fetal skull which is firmly connected with the model by means of a flexible metal tube which can be fixed in every position. It facilitates the students to get an integral knowledge of normal labor of a pregnant women.



XC-117

XC-117 LUMBAR SET (3 PCS)

Life size lumbar vertebrae are shown with normal intervertebral disc and spinal cord with nerve roots. Mounted on a sturdy metal rod.

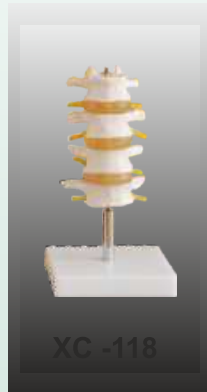

XC -118

XC - 118 LUMBAR SET (4PCS)

Life-size lumbar vertebrae are shown with normal intervertebral disc and spinal cord with nerve roots. Mounted on a sturdy metal rod.

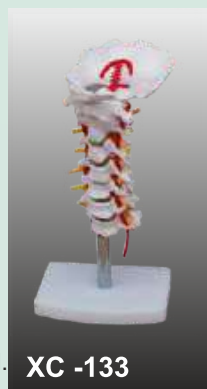

XC -133

XC - 133 CERVICAL VERTEBRAL COLUMN WITH NECK ARTERY

This model shows Cervical Vertebral Column with neck artery and nerve roots.

XC - 119 LUMBAR VERTEBRAE WITH SACRUM & COCCYX AND HEARINATED DISC LIFE SIZE

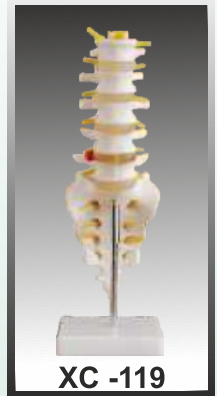

XC -119

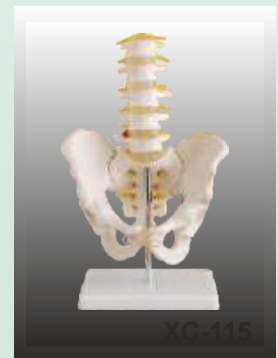

XC-115

XC - 115 PELVIS WITH 5PCS LUMBAR VERTEBRAE

Life -size Lumbar Vertebrae are shown with normal intervertebral disc, spinal chord and pelvis.

IMPORTED SKELETON MODELS

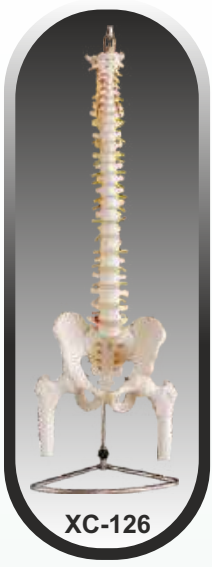

XC - 126 VERTEBRAL COLUMN WITH PELVIS AND FEMUR HEADS (TALL 85 CM) This highly detailed life-size model shows all significant features of each vertebra, including spinal cord, nerve roots, the vertebral artery, a herniated disc and vertebral notch etc. Ideal teaching model for students, patient education of chiropractors, orthopedic surgeons and other medical professionals. Special features include: inflexible 29" tall vertebral column complete with pelvis, sacrum, occipital bone, vertebral artery, all nerve branches and herniated lumbar disc. Deluxe chrome stands.

XC-103/SK046 MINI HUMAN SKELETON (TALL 42 CM)

This most popular miniature skeleton model offers an unique hands-on learning experience for young scientists, curious kids or medical professionals. Special features include a movable jaw on springs, a skull whose top half opens for a look inside, arms and legs that are removable for individual study. . Mounted on stand. Made of washable and unbreakable PVC plastic.

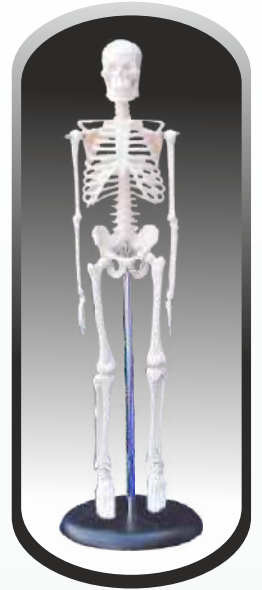

XC-104C ADULT SKULL (COLOURED) LIFE SIZE
Life-size skull, bones painted in different colors for precise study. Disassembled into 3 part.

GD/A11115 INFANT SKULL MODEL
Material: Advanced PVC
A Complete Set

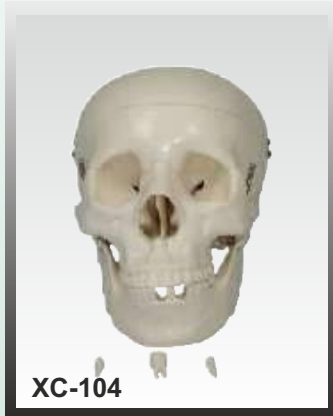

XC - 104 ADULT SKULL LIFE SIZE

A life-size adult PVC plastic skull features a movable jaw, cut calvarium, surface lines and 3 removable lower teeth-incisor, cuspid and molar. Dissectible into 3 parts. Size 19x15x21 cm

XD-121 FOETAL CHILD SKULL (INFANT SKULL)

This Fetal Skull is detailed to show the major structure of the different bones of the skull. The mandible is spring hanged to view the bone structures of the mouth. This model is lifelike and made PVC plastic. size: 10x8x10cm

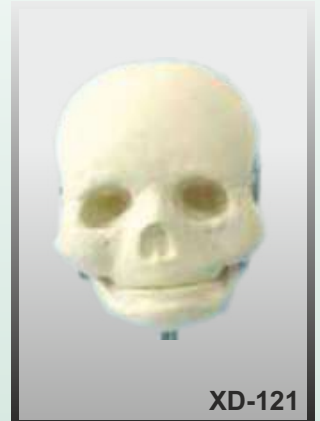

XC-104E SKULL MODEL WITH 8 PARTS BRAIN

New This model includes 8 parts brain: frontal and parietal lobe, temporal and occipital lobe, encephalic trunk and cerebellum.



XD-104-1 DISARTICULATED SKULL

This highly detailed Human Skull model is Disarticulated into many sections. The calvarium is sectioned horizontally with the lower jaw hinged. The basal portion of the skull has been sectioned sagittally, displaying all 3 sinuses.





XC-307

XC - 307

JUMBO HEART MODEL

This model helps the students to understand the external features and internal structures of the heart, and its relation with the large blood vessels. Thus a clearer conception of the routes of the systemic and pulmonary circulation can be obtained. Dissectible into 3 parts, 4 times enlarged. Made of PVC plastic. Mounted on base. Size : 25x23x23cm.

XC-307A / PD-002

HEART MODEL

LIFE SIZE

This life-size heart model excellent for patient education or elementary science classes. Anatomically accurate and great for learning basic external and internal anatomy of the heart. Dissectible into 2 parts. Made of PVC and mounted on stand. Size: 15x8x9cm

New

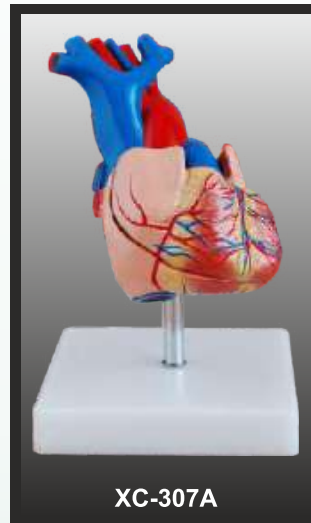

XC-307A

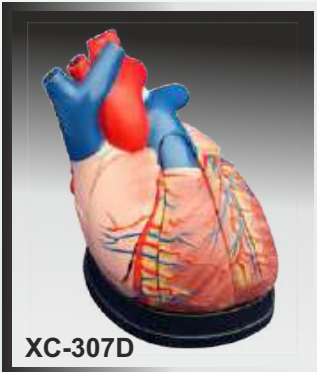

XC-307D

XC-307D

MIDDLE HEART MODEL

This model shows external features and internal structures of heart and its relation between large blood vessels. Dissectible into 5 parts, 3 times enlarged.

XC - 320

LARYNX, HEART AND LUNGS MODEL

A life-size model separating into 7 parts. The lungs have two removable lobes to show the internal structures, the heart bisects showing atria, ventricles and valves, the larynx bisects and the diaphragm is shown. On base. Size : 36x23x12 cm.



XC-315



XC-320

XC - 308

BRAIN WITH ARTERIES

This 8-parts model facilitates the medical students to get a correct understanding of the external features of the brain and its arterial supply as a whole, as well as the relations between their component portions. External features of the brain: cerebral hemisphere, brain stem, cerebellum. The arterial supply of the brain: sources, vertebral, internal carotid arteries, arterial supply of the cerebellum and cerebrum. Made of PVC plastic. On base. Size: 18.5x14x13.5 cm.

XC - 306

STOMACH MODEL

This model shows the morphology of the stomach in a moderate distended state. With the longitudinal section, the model shows the structures of the gastric folds, pyloric sphincter muscles, gastric mucosa and the transitional mucosa of the gastric-esophagus. Made of hard plastic and magnified 2 times the natural size.



XC-306

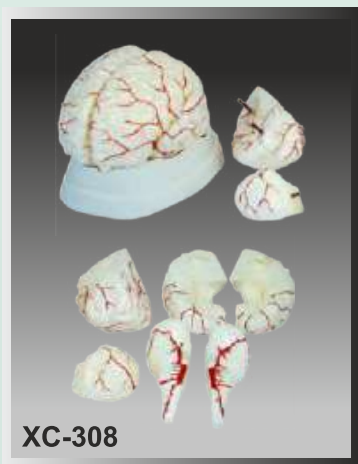

XC-308

IMPORTED ANATOMICAL MODELS

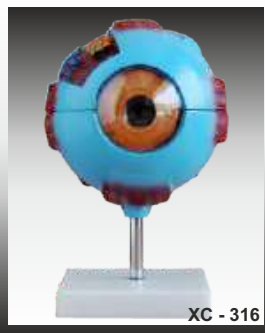

XC - 316 GIANT EYE MODEL

The different parts of the eyeball model are detachable to show the following structures:-

1. Tunica external: showing cornea and sclera with attachments of ocular muscles and optic nerve.
2. Tunica media: showing the iris, the ciliary body and the chorioid.
3. Tunica internal is retina.
4. Refraction media: showing the lens and the vitreous body.

The model is made of PVC plastic . Mounted on stand, 6 times enlarged.



XC-316B EYE WITH ORBIT

This model shows eyeball with optic nerves and muscles in its natural position in the bony orbit. Dessectible into 10 part. 3 times enlarged.



XC-313-2 SKIN BLOCK MODEL ENLARGED

This model shows a section of human skin in three dimensional forms. Hair, sebaceous and sweat glands, receptors, nerves and vessels are sweat glands, receptors, nerves and vessels show in detail 70 time enlarged.



XC-313 SKIN MODEL ENLARGED

A greatly enlarged (105 times) cross sectional view of the human skin showing three layers and a close-up view of a hair follicle, sweat gland, fatty tissue and more. Front, side and back view. Made of PVC plastic. Mounted on base.

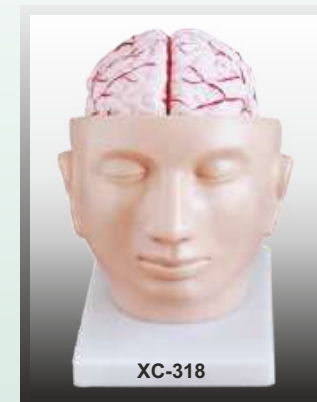

XC-324 MODEL OF THE HEAD

This model shows the interior parts of the mouth cavity and pharynx with network of vessels and trigeminal nerves.



XC-318 BRAIN WITH ARTERIES ON HEAD

This model shows the brain structure inside the skull. Two halves brains can be dissembled into: frontal with parietal lobes, temporal with occipital lobes, half of brain stem, half of cerebellum. Life size dissectible into 9 parts.

GD/A13001

New

NASAL, ORAL, PHARYNX AND LARYNX CAVITIES MODEL

A model of the respiratory system, including the oral, nasal cavities, pharynx and larynx. The upper respiratory tract is dissected into two pieces along the medial sagittal plane Ten parts and 113 positions are displayed Size: Two times of Life size, 42x25x20.5cm

Material: PVC and paint

G.W. : 5.5 kg.



ALL THESE MODELS ARE DURABLE AND UNBREAKABLE



XC - 204
UNISEX TORSO 23 PARTS
(TALL 85 CM)

This outstanding torso features an exposed spine with removable vertebra and spinal cord segments, a female breast plate and interchangeable male and female genitalia. The female organs include a fetus in the womb. Dissectible into 23 parts: torso, female breast plate, head, eyeball, brain, vertebra spinal nerves, lung (2 parts), heart (2 parts), liver, kidney, stomach (2 parts), intestines (4 parts), male genitalia (2 parts), female genitalia with fetus (3 parts). Made of PVC plastic. Mounted on base.

XC - 203
TORSO 15 PARTS
(TALL 26CM)

This torso features: torso, brain (2 parts), cut calvarium, heart, lung (4 parts), stomach, diaphragm, liver, heart, trachea & esophagus & aorta, pancreas and spleen, intestine etc. Dissectible into 15 parts. Made of PVC plastic. Mounted on base.



XC-205/MK-050
TORSO (TALL 50 CM)

This unisex torso features the same as XC-204 but the half size, offering an outstanding educational value. Dissectible into 23 part: torso, female breast plate, head, eyeball, brain, vertebra spinal nerves, lung (2 parts), heart (2 parts), liver, kidney, stomach (2 parts), intestine (4 parts), male genitalia (2 parts), female genitalia (3 parts). Made of PVC plastic. Mounted on base.

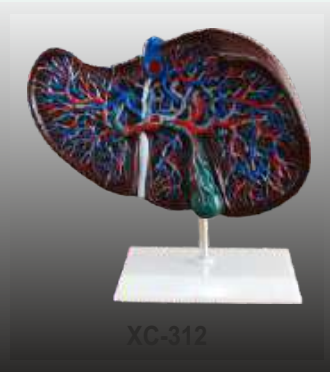

XC-312
LIVER MODEL

An economical way to study the basic structure of the liver. The complex vessels network in the opened liver, displayed in different colors on his model: hilus vessels, extra-hepatic and intrahepatic bile ducts. Liver mounted on stand.

MK029
PUMPING HEART

1. A 3-D working plastic heart model with clear chambers. Squeeze bulb pumps simulated blood through clear heart chambers just like real one.
2. Complete heart model scale with display stand.
3. Complete instruction manual, easy to assemble.
4. Acrylic Paints and Brush are included.



GD/A42004
EMBRYO MODEL

Mounted on stand Made of Advanced PVC 4 weeks old embryo. Shows 12 Positions

XD-311-1
MODEL OF SPLEEN PANCREAS AND DUODENUM

This natural size model reproduces the pancreas, the spleen and the duodenum. The pancreas is open to show the entire pancreatic duct. The duodenum is partially dissected to expose its nice structure.



XC - 303C

GIANT SIZE EAR MODEL NEW STYLE

A giant model of the ear, shows the three main structural parts of the hearing organ (external ear, middle ear, internal ear) and the position of the equilibrium organ of human body.

1. **External Ear** : Showing the shape of the auricle and the primary features of the external auditory meatus.
2. **Middle Ear** : Showing the tympanic membrane, the three auditory ossicles (hammer, anvil, stirrup) and the eustachian tube.
3. **Internal Ear** : Showing the vestibule, cochlea and the three semicircular canals of the osseous labyrinth.

Made of PVC plastic. Mounted on plastic base. 5 times enlarged. Dissected into 6 parts.

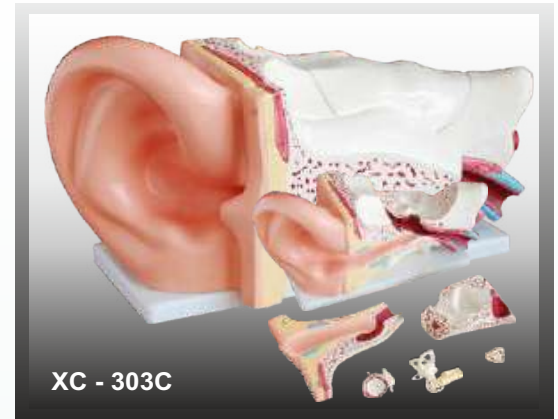

XC-403/TH-001

TOOTH HYGIENE SET - CONSISTS OF TEETH, TONGUE AND PALATE WITH BRUSH

This model is to serve for demonstration in mouth protection and relative clinical teaching. Consists of gum, teeth, tongue and palate. It demonstrates teeth form and oral cavity cleaning and protection.

TH-002

DENTAL MODEL SMALL

- Model with Plastic Hinge



XC-305

EXPANSION MODEL OF HUMAN TEETH

This model shows the morphological differences of the incisor, canine and molar teeth. Dissections of the canine and molar teeth demonstrate the structure of enamel, dental pulp cavity. Enlarged 12 times, 3pcs set.



XC-317

EXPANSION MODEL OF URINARY BLADDER

This model shows the male urinary bladder with the prostate gland surrounding the urethral. Dissected medially to expose both internal and external structures.

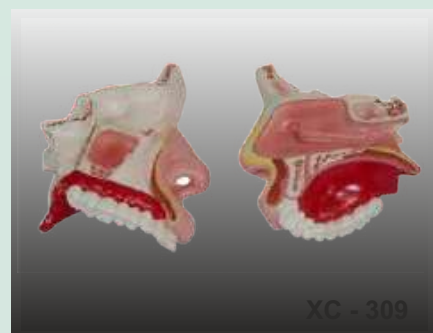

XC - 309

MODEL OF THE ANATOMICAL NASAL CAVITY

This model helps the students to understand the external and internal structures of the nasal cavity.

1. **External Nose** : Show the section of the nasal bones and cartilages.
 2. **Nasal Cavity** : On the lateral nasal wall show the superior, middle and inferior nasal conchae project medially into the nasal cavity forming the superior, middle and inferior nasal meatuses.
 3. **Paranasal Sinuses** : Shows the frontal, sphenoid and maxillary sinuses.
- Magnified 1/2 the natural size. Made of PVC plastic.

IMPORTED ANATOMICAL MODELS



XC-330

XC - 330

MODEL OF THE TRANSPARENT LUNG SEGMENT

This model presents 10 segments in the right lung and 8 in the left. The distributions of the bronchial tree can be observed through the transparent lungs.

1. **Right Lung:** right upper lobe (3 segments), right middle lobe (2 segments), right inferior lobe (5 segments).
2. **Left Lung:** left upper lobe (4 segments), left inferior lobe (4 segments).
3. **Distribution of the bronchial tree:** right bronchus, left bronchus.
4. **Hilus of lung.**

The lungs are made of transparent plastic. The trachea and bronchial tree made of PVC plastic . Enlarged 2 times.



XC - 301

XD-330-1

LUNG DEMONSTRATION MODEL

Students can demonstrate how the lungs work with this transparent lung model. Constructed of two rube balloons, rubber stopper and bell jar. Pull the thin rubber diaphragm at the bottom of the jar down to see the lungs inhaling. Push it in and the balloons will collapse (exhaling)
Size: 17x17x20

XC-301

MAGNIFIED HUMAN LARYNX MODEL

A functional model that demonstrates movements of the epiglottis and cartilages in the voice box. It helps the students to require an understanding of the morphology and structure of the respiratory tract and phonetic organ. On base. 3 times enlarged. 3-parts dissectible.



XD-330-1

XC-311

LIVER, PANCREAS AND DUODENUM MODEL

An easy way to study the basic structures of the liver, spleen, blood vessels and pancreas. External structures are illustrated as well as the pancreatic duct of the pancreas. This model also show the abdominal aorta and inferior and interior vena cava. Life size. Dissectible into 3 part. Made of PVC Plastic. Mounted on stand.



XC-302

XC-302

MAGNIFIED PULMONARY ALVEOLI MODEL

A model shows the small branches of principal bronchus:

1. Section of bronchiole of no cartilage.
2. The relation between pulmonary alveoli & terminal bronchiole.
3. The structure of alveolar sac and alveolar duct.
4. The capillary rete in the alveolar septa.

Made of PVC plastic and mounted on base.

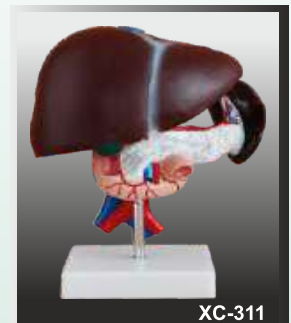

XC-311



XC-310-1



XC-310-2

XC-310-3

HUMAN KIDNEY WITH ADRENAL GLAND

The detailed life-size model features the kidney, adrenal gland, renal and adrenal vessels and upper portion of the ureter. Dissectible into 2 parts to reveal the cortex medulla, cortex vessels and renal pelvis. Model can be removed from the stand for instruction. Life - size Mounted on stand.

XC-310-1 KIDNEY MODEL (1 PART)

XC-310-2 KIDNEY MODEL (2 PART)

The coronary section of the right kidney shows the renal hilus, renal blood vessels, ureter, renal pelvis of the kidney the renal substance is demonstrated by its medulla and cortex, medullary pyramid, papillae etc. Made of PVC plastic, 2 times enlarged. Mounted on stand.

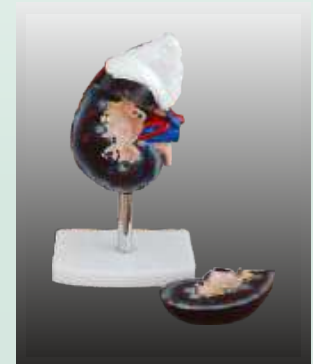

IMPORTED ANATOMICAL MODELS

GD/A42008

FETUS WITH VISCUS AND PLACENTA

1. Separated into 13 parts as follow: Placenta, umbilical cord, abdominal cover, lungs, heart, thymus, diaphragm, liver, stomach, intestine, body.
2. Shows a female fetus at the end the pregnancy with placenta and umbilical cord.
3. Made of Advanced PVC.

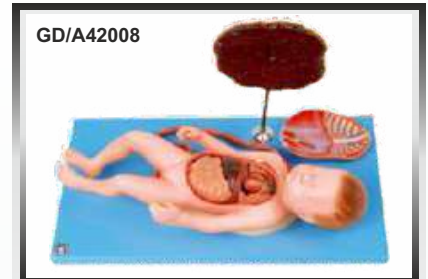

GD/A41003

OVARY MODEL

1. Consists of 8 parts, mounted on stand.
2. Show ovary, primary and secondary ovarian follicles, ovium, ovulation, ovum, corpus luteum, corpus albicans.
3. It demonstrates the procedure of ovum's development.
4. Shows 10 positions.
5. Made of advanced PVC.



XC-409

NEWBORN BABY MODEL

XC-409A

NEWBORN BABY MODEL (MALE)

XC-409B

NEW STYLE NEWBORN BABY MODEL (F)

The size and configuration of this model is almost as same as the normal newborn baby. The head, upper limbs, lower limbs and all joints are flexible. It can demonstrate the characteristic of the newborn baby and all kind of operations in clinic education: includes different parturition method, newborn baby bath etc. Made of soft PVC plastic. Washable. Length: 52 CM, head diameter:34CM.

GD-F6/XC-402

MODEL FOR COURSE OF DELIVERY (LEOPOLD MANUVERS SIMULATOR)

The model basing on the mechanism of normal labor, shows the cardinal movements of engagement: descent-flexion-internal rotation of the head-extension-retitition-external rotation of the head-internal rotation of the shoulders at accouchement. Suitable for teaching the mechanism of normal labor in medical colleges and nursing schools.

XC-414-A

New

DEVELOPMENT PROCESS FOR FETUS (HALF SIZE)

This model shows relationship between fetus and uterus in 1st, 2nd, 3rd, 4th, 5th, 6th, 7th month pregnancy, and twins course in the 5th month. Consist of 8 parts



XC-410

NEWBORN INTUBATION BABY MODEL

This model is used to demonstrate the newborn baby intubation and train the students to learn intubation skills. Served as an ideal model for medical college, nursing schools and hospital etc. Made of elastic PVC plastic.

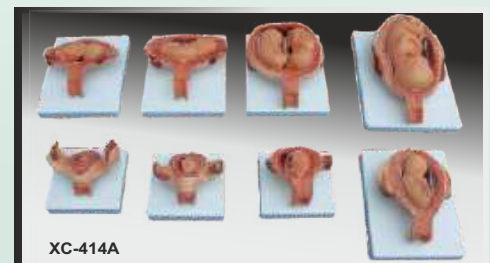

XC - 414

DEVELOPMENT PROCESS FOR FETUS

1. Normal uterus, shows the inner genitals of female.
2. Shows the embryo and uterus in the first month of gestation, placenta is shown also.
3. Shows the fetus & uterus in the second month of gestation, the embryo is just looks like human.
4. Shows the fetus and uterus in the third month of gestation, the height of the fetus is about 9 cm.
5. Shows the fetus and uterus in the fourth month of gestation, the height of the fetus is about 16 cm.
6. Shows the fetus and uterus in the fifth month of gestation, the height of the fetus is about 25 cm.
7. Shows the fetus and uterus in the sixth month of gestation, the height of the fetus is about 30 cm.
8. Shows the fetus and uterus in the seventh month of gestation, the height of the fetus is about 35 cm.
9. Shows the fetus and uterus in the eighth month of gestation, the height of the fetus is about 40 cm.
10. Shows the fetus and uterus in the ninth month of gestation, the height of the fetus is about 45 cm.

Dimension: Natural size, on the base.

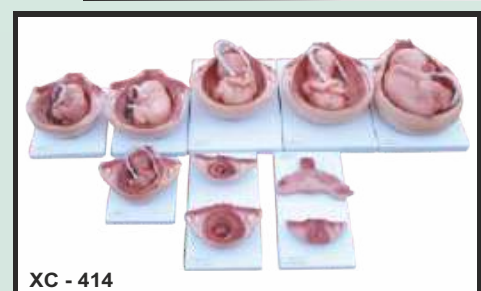



XC-332B



XC-332B

XC-332B

HUMAN FEMALE PREGNANT PELVIS SECTION WITH FETUS

Life size: shows medium section of the right half of female pelvis. A9 month fetus is removable. A-3 month fetus is included for comparison. An excellent model for study of Human Embryo Development.

On base. Made of PVC plastic.

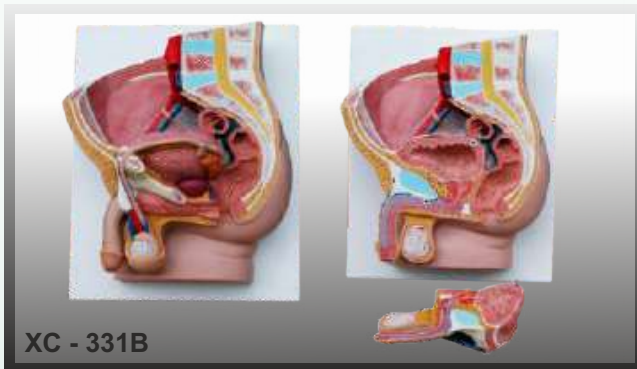

XC - 331B

XC - 331C

ADVANCED MALE INTERNAL & EXTERNAL ORGANS

The model clearly and accurately demonstrates the anatomy of rectum, seminal vesicle, bladder, pelvic bone, prostate, urethral sphincter muscle, urethral meatus, glans, scrotum, pelvic diaphragm and anus. This model also allows you practice proper insertion of a catheter using sterile techniques.

XC - 332C

ADVANCED FEMALE INTERNAL & EXTERNAL ORGANS

The model clearly and accurately demonstrates the anatomy of rectum, uterus, bladder, pelvic bone, urethral, sphincter muscle, clitoris, urethral meatus, labium minora, vagina, labium majora, pelvic diaphragm, and anus. This model also allows you practice proper insertion of a catheter using sterile techniques.

XC - 331

MALE UROGENITAL SYSTEM

This is intended for schools and colleges as a visual aid in teaching physiology and hygiene to help the students to understand the external features of the urogenital system and the internal structures of the kidney, urinary bladder, penis and testicle. Made of soft PVC plastic.

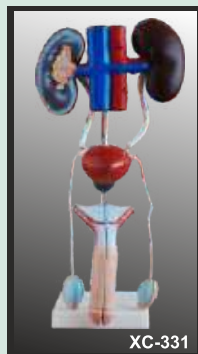

XC-331

XC-332A

HUMAN FEMALE PELVIS SECTION (1 PART)

The model is a median section shows female genital organs with bladder and rectum. The abdominal and pelvis muscles are shown detailed. Made of PVC plastic.

XC-331A

HUMAN MALE PELVIS SECTION (1 PART)

This median section model shows male genital organs with bladder and rectum in male pelvis.

Made of PVC plastic. On base.



XC-332A

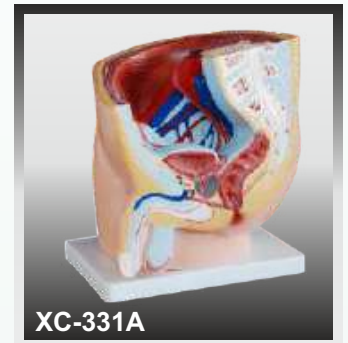

XC-331A

XC - 331B

HUMAN MALE PELVIS SECTION (2 PART)

The model is a median section shows male genital organs with bladder and rectum. The abdominal and pelvis muscles are shown detailed. Made of PVC plastic.



XC - 331C



XC - 332C

XC - 332

FEMALE UROGENITAL SYSTEM

This model serves as a teaching model for teaching to teach the female urogenital system in schools and colleges. The model shows kidney, ureters, urinary bladder, uterus, accessories of uterus, vagina, ovary membrane, ligaments, uterus ligament and artery etc. Made of PVC plastic.

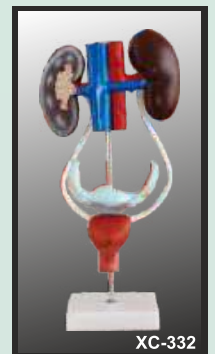

XC-332

IMPORTED NURSE TRAINING MODELS



GD/L69D

ADVANCED NEONATAL PERIPHERAL AND CENTRAL VEIN INTUBATION SIMULATOR

Designed according to the physiological and anatomical characteristic of neonate, made of imported plastic material, soft and elastic skin, easy to clean and provide technology of inserting into central vein catheter via peripheral vein

Features:-

- Transparent chest wall and made of special material, perspective effect of bilateral venous Chanel
- Correct anatomical position: basilica vein, cerphalic vein, jugular vein, subclavian and superior vena
- Direct observation of rib and heart, measure the correct inserted length of catheter
- Transparent part of the superior vena and visible of the ductal position in the case of correct catheterization or the catheter is invisible
- Exercise of standard venous catheterization position



GD/J140

BABY OBSTRUCTION/INFANT C.P.R. SIMULATOR

Full-body lifelike baby specifically designed for professional training of Heimlich manoeuvre, foreign-body airway obstruction feature provide a realistic condition for releasing of a foreign body obstruction through back blows and chest thrust techniques



GD/J15

NEONATE INTUBATION TRAINING MODEL

Feature:

- Realistic anatomy of neonate
- Oral and nasal intubation
- Lifelike material
- Directly observe the expansion of lungs and stomach by insufflating air into the tube and stomach so as to verify if the ube position is right

GD/L69B

CENTRAL VENOUS CATHETERIZATION SIMULATOR

The cervicular veins are filled with red simulative blood for internal jugular vein and subclavical vein puncturing use. Squeeze bulb can simulate carotid artery pulse. With accurate anatomy, palpation is exactly the same as on a patient. Replacing of the internal tubing and skin is extremely easy.

Features:-

- Cervical anatomical landmarks are quite clear and indicate structures of the sternal notch, clavicle, right cervical ribs, sternocleidomastoid etc.
- Venous system in the deep part of left neck consists of commo carotid artery, internal jugular vein, external jugular vein, subclavical vein, and brachiocephalic vein
- Internal jugular vein puncture and cannulation can be exercised
- Subclavical vein puncture and cannulation can be exercised
- Carotid artery pulse can be simulated
- The skin and veins can be replaced and students will feel an apparent
- "POP" when the needle has been thrust into the vein
- The heart floating swan-ganz intubation can be exercised





GD/A15102

MALE GENITAL ORGANS MODEL

Dissected in median and mounted on a stand Shows the penis, prostate, bladder, seminal vesicle, spermatic cord and inguinal canal and base Shows 72 Positions

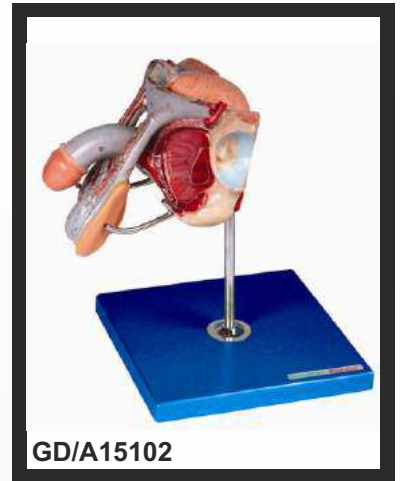

GD/A15102

GD/A15105

FEMALE GENITAL ORGANS

Dissected & mounted on a stand Shows internal and external female genital organs Shows 40 Positions Made of Advanced PVC

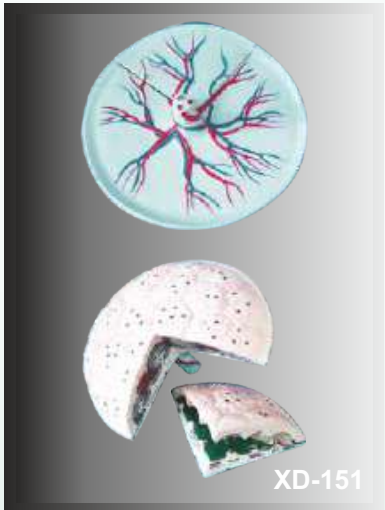

XD-151

XD-151

HUMAN PLACENTA ANATOMISE MODEL

- Shows the structure of placenta and the relation between placenta and umbilical cord
- Mounted on stand
- Made of Advanced PVC
- Seven positions are displayed

GD/A12006

APPENDIX AND CAECUM

Made of advanced PVC Mounted on a stand, Natural size Shows wall of the caecum and appendix Separated into 2 parts Shows 17 positions

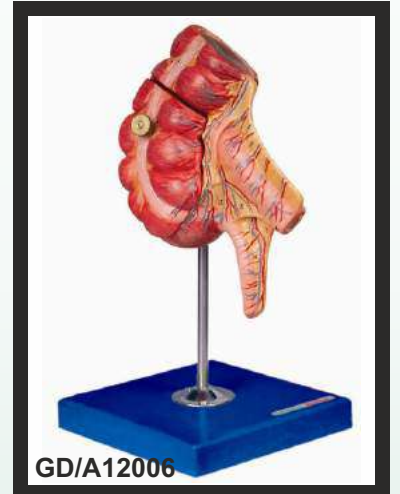

GD/A12006

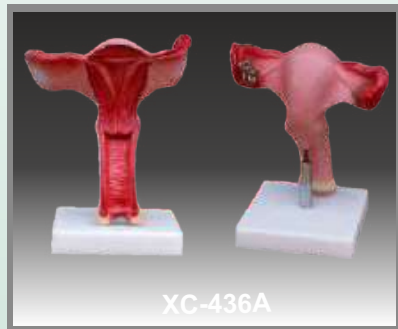

XC-436A

XC-436A

MAGNIFIED UTERUS MODEL

With the coronal section this model show:

1. Uterus
2. The cervix is divided into a supra-vaginal portion and a vaginal portion.
3. The ligaments of the uterus are eight in number.
4. The fallopain tubes.
5. The Ovaries



XC-333

XC-333 URINARY SYSTEM MODEL

The model shows the structures of retroperitoneal cavity, pelvis with bones and muscles, inferior vena cava, aorta with its branches, upper urinary tract, kidney with adrenal gland, ureter, bladder, etc. Dissectible into 4 parts.



GD/A18001

GD/A18001

NEURON MODEL

Consists of 2 parts Shows neuronal body and nerve fiber, neuronal axon hillock, dendritic arbor, neurofilament etc Shows 15 positions Made of Advanced PVC



XC-429

XC-429 ₹ FEMALE INTERNAL & EXTERNAL GENITAL ORGANS

This model is served as a visual aid in teaching human anatomy in nursing and medical college. It shows the female genital including uterus, uterus appendix (fallopian tube, ovary and its membrane, ligament teres uteri, ligament ovary proprium), vagina and the structure of external genital organ. Part of uterus & vagina are dissected to show its internal structures. Size Life size.

IMPORTED NURSE TRAINING MODELS

GD/HS39



GD/HS39

FULL-FUNCTIONAL VEIN INJECTION ARM

Complete Venipuncture Arm:-

- Venous access-Basilic V Cerphalic V Digital V Dorssal Metacarpal V Median Basilic V Accessory Cephalic V Extensive venipuncture system Median Antebrbra V Median Cephalic V Median Cubital V Thumb
- This revolutionary training arm provides complete venous access for IV therapy and phlebotomy, plus sites for intramuscular and intradermal injection. An extensive 8-lined vascular system allows students to practice venipuncture at all primary and secondary locations, including starting IVS and introducing Over the Needle IV Catheters. The Venous system simplifies setup with only one external fluid bag supplying artificial blood to all veins simultaneously. The dorsal surface of the hand includes injectable
- Metacarpal, digital and thumb veins. The antecubital fossa includes the median cerphalic, median basilica, and median cubital veins. Venipuncture can also be performed along the basilica, cephalic, accessory cephalic and median antebrachial veins. Intramuscular injection may be performed in the deltoid muscle and intradermal injection sites are located in the upper arm. Intramuscular injections into the deltoid muscle are enhanced by the soft, lifelike skin and by the natural bony landmarks in the region. Intramuscular injections using distilled water will create characteristic skin welsat designated sites on the upper arm.
- The realism of the advanced venipuncture and injection Arm is truly amazing. The soft, flexible fingers are molded separately with extreme attention paid to every detail-right down to the fingerprints! Flexion of the wrist helps students to develop manipulates skills. The replaceable skin rolls as the veins are palpated and a disdernable "POP" is felt when entering the veins. The molding process reproduces the fine details of the skin to make the arm look and feel alive. Valves in the veins can be seen and palpated on the skin surface
- Simulated veins and skins are completely replaceable to keep this training arm looking and working like new. Under normal use, hundreds of injections may be performed before the veins or skins need to be replaced. Complete replacement kits are available and easy to use. To extend the life of the veins and aerosol sealant is available to seal punctures and prevent leakage.



GD/F9B

GD/F9B

ADVANCED FEMALE CONTRACEPTION PRACTICE MODEL

Features:

- This Model simulates ante version uterus, fallopian tubes, labium, vagina and transparent abdominal wall cover in the pelvic cavity.
- Expansion of vagina, the use of vaginal speculum, operation of female condom, contraceptive sponge and cervical cap.

GD/F5M

MALE CONDOM TRAINING MODEL

Features:

- This model of an erect penis with testicles is used to quickly learn how to use a condom safely.
- The anatomical structures and its firmness are absolutely realistic, so that your students can train putting on and removing a condom in a realistic way.



GD/F5M



GD/HS2

GD/HS2

MULTI-FUNCTIONAL ADULT IV TRAINING ARM MODEL

This adult vein puncture and Injection Training Arm has all the 8 veins of the vascular system of the arm, it helps to provide a good training of injection, infusion and phlebotomization.

This model can provide a real life like feel when the students practice on this



GD/A11301

GD/A11301

MALE MUSCLE FIGURE WITH INTERNAL ORGANS (TALL 78 CM)

1. This model consists of 27 parts, such as muscles of chest wall and abdomen, muscles of upper and lower limbs, skull, brain and viscera. It shows the structure of head, neck, torso, upper and lower limbs, muscles, muscular tendon, ligaments, viscera, blood vessels, brain etc.
2. Material: Advanced PVC and painted with imported paint

XC-407

HUMAN TRACHEA INTUBATION MODEL WITH MONITOR

XC-407-B

HUMAN TRACHEA INTUBATION MODEL WITHOUT MONITOR

This model is designed as a teaching model for training the medical students, basic clinic nurses and first aid people to demonstrate and practice trachea intubation through mouth.

1. Trachea intubation through mouth.
2. Compare pupils: One is normal, another is large.



XC-407
XC-407-B

GD/J50 AIRWAY INTUBATION SIMULATOR

Features :

- Accurate anatomical parts.
- Oral or Nasal Cavity intubation.
- Allows observing the suction position from side face so as to instruct correct method of the intubation skill.
- Wrong operation, stomach inflating or laryngoscope compressing the teeth will activate warning prompting.

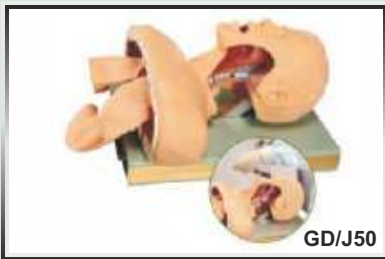

GD/J50



GD/J55

GD/J55

MULTI FUNCTIONAL AIRWAY MANAGEMENT MODEL

Features:

- Anatomically accurate full size mouth, tongue, airway and esophagus.
- Perfect for placement of endotracheal tubes.
- Respiratory sound auscultation.
- Oral, nasal intubation.
- Oral, nasal suction.
- Soft neck with cricoid cartilage permits classic
- Sellick maneuver needed to provide better view of the vocal cords.

XC-405

NURSE BASIC PRACTICE TEACHING MODEL

- This training model is designed according to human anatomy and suitable for nursing schools, colleges and hospitals for demonstration and practice.
- It has 5 parts and can demonstrate 15 operations:-

- Part 1:** Upper and front part of male body. **Part 2:** Left arm
Part 3: Male lower abdomen and perineum **Part 4:** Buttock
Part 5: Female perineum.



XC-405



GD/HS10C

GD/HS10C

ADULT INTRAMUSCULAR INJECTION TRAINING MANIKIN

Structure of left gluteal : osteal marks, gluteal muscles, ischiadic nerve and veins.

Left gluteal can be taken off. So it is easy to observe internal structure and make sure position of ischiadic nerve and veins. Gluteal intramuscular injection training.

IMPORTED NURSE TRAINING MODELS



XC-434

XC - 434

INJECTABLE TRAINING ARM MODEL

This arm model can demonstrate the following items:

1. Vein phlebotomy on elbow forearm.
2. Vein injection on elbow forearm.
3. Vein blood transfusion on elbow forearm.
4. Vein liquid transfusion on elbow forearm.
5. Muscular injection on deltoid on the side of upper limb.

XC - 431

BUTTOCK INJECTION MODEL

This model shows the location for muscle injection on the buttock, supply for training the students to learn injection skills.

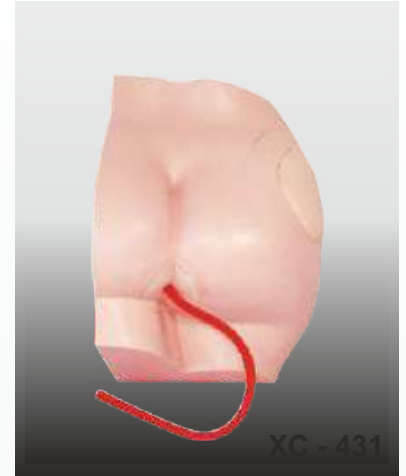

XC - 431



GD/LV1

GD/LV1

ADVANCED SURGICAL SUTURING ARM MODEL

1. Allows student to practice cut, suturing, stitches release, enswathing etc.
2. The elasticity and flexibility of skin allows practice hundreds times.
3. If all the initial wounds have been sutured, student cant cut the arm in other place for new training of suturing.



GD/LV2

GD/LV2

ADVANCED SURGICAL SUTURE

LEG This model Advanced Surgical Suture Leg allow students to practice cut, suturing, stitches release, enswathing, etc.

- The elasticity and flexibility of skin can make if for practice hundreds times.
- If all the initial wounds have been sutured, students can cut the leg in other place for new training of suturing.



GD/HS6E

GD/F3B

VULVA SUTURING TRAINING SIMULATOR

- This model demonstrates the different position in pudendum.
- It's made of soft materials, can be used in many times suturing training.



GD/F3B

GD/HS6E

NEONATE SCALP VENIPUNCTURE MODEL

Features:

- This model has main veins of scalp, including venae temporales superficiales vein and venae frontales, and can be used to infusion, injection and phlebotomy.
- There is obvious feeling when needle penetrates into the veins. Blood flash back indicates proper insertion;
- These operations won't cause leaks.

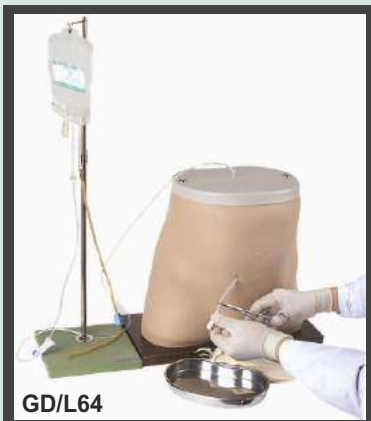

GD/L64

GD/L64

PERITONEAL DIALYSIS SIMULATOR

This Model is a specially designed simulator for the medical staff to practice the skill of peritoneal dialysis. Fistula orifice is in the realistic position, and the simulative liquid flow out through it. Standard Equipment includes Catheter, Disposable waterproof fabric, Infusion Stand, Liquid Bag, Deluxe Portable Box

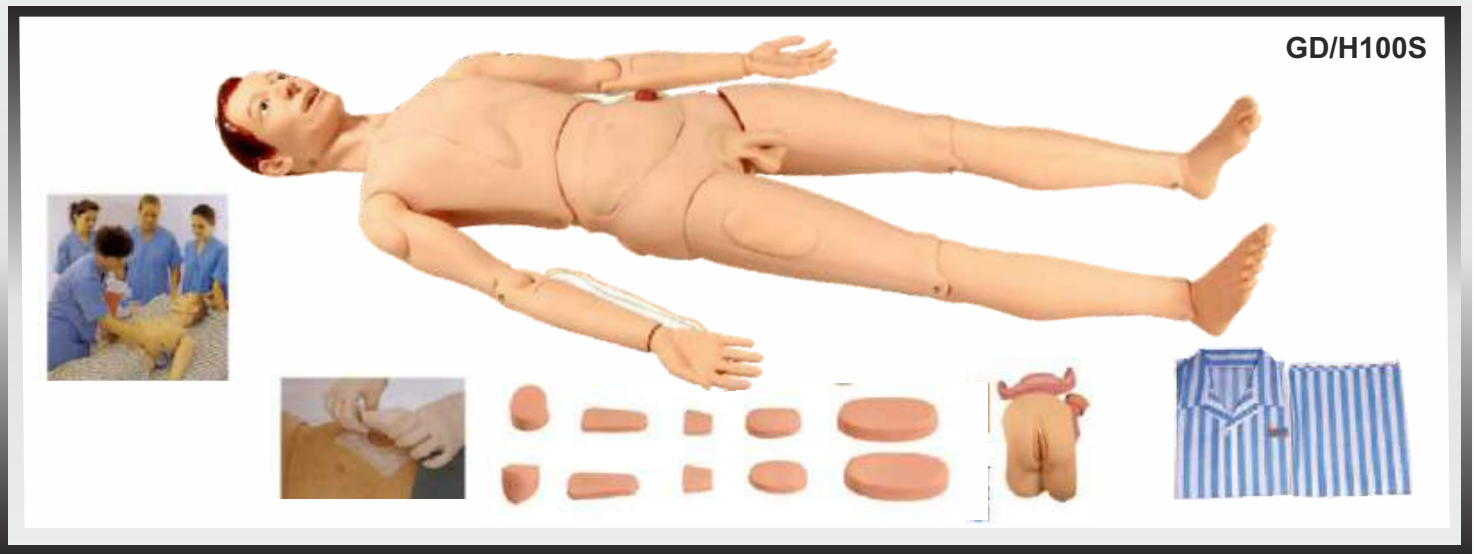

GD/H100S BASIC COMBINATION NURSING MANIKIN

Full-Body Life Like Male Manikin

Specially Designed for Professional Trauma Nursing Care

High Quality Manikin provides wide range of exercises

NURSING SKILLS:

- | | |
|--|--|
| <ol style="list-style-type: none"> 1. Bed Bathes, Dressing and Undressing 2. Hair Washing 3. Face Washing 4. Irrigation of the Eyes and Ears 5. Oral Cavity Care 6. Oxygen Inhalation 7. Nasal Feeding 8. Lavage 9. Oral Cavity Intubations 10. Nasal Cavity Intubations | <ol style="list-style-type: none"> 11. Tracheotomy Care 12. Organs Structure of Thorax 13. Venipuncture and Injection, Transfusion 14. Deltoid Injection 15. Male Urethral Catheterization 16. Female Urethral Catheterization 17. Gluteus Injection 18. Ostomy Irrigation 19. Organs Structure of Addominal Cavity |
|--|--|



GD/H2 MULTI-FUNCTIONAL NURSING MANIKIN

- | | | |
|---|---|---|
| <ol style="list-style-type: none"> 1. Face Washing and Swab Down 2. Oral Cavity Nursing 3. Tracheotomy Nursing 4. Oxygen Inbreathe 5. Nasal Feeding 6. Stomach Washing 7. Intracardiac Injection | <ol style="list-style-type: none"> 8. CPR First Aid 9. Mammary Nursing 10. Thoracic Puncture 11. Liver Puncture 12. Celiac Puncture 13. Medulla Puncture 14. Lumbar Puncture | <ol style="list-style-type: none"> 15. Deltoid Puncture 16. Deltoid Subcutaneous Injection 17. Vein Injection 18. Vein Puncture 19. Vein Transfusion 20. Female Catheter 21. Female Clyster 22. Gluteus Intramuscular Injection |
|---|---|---|

IMPORTED NURSE TRAINING MODELS

XC-401A HIGH QUALITY NURSE TRAINING DOLL (MALE) UNISEX

XC-401B HIGH QUALITY NURSE TRAINING DOLL (FEMALE) UNISEX

Full-body Lifelike Mannequin

Specially designed for Professional Nursing Training

High Quality Mannequin provides wide range of exercises possible including both first aid and emergency situations.

NURSING SKILLS:

1. Lifting, Carrying and Moving of the patient
2. Bed Care of the patient
3. Bathing (Genital Care) Hair washing and face washing
4. Oral Cavity Care
5. Care and Cleaning of the Nose
6. Prevention of Bedsores (Decubitus)
7. Prevention of Muscles Cramps
8. Prevention of Pneumonia
9. Prevention of Blood Clots (Thromboses)
10. Prevention of Thrush and Parotitis
11. Physiotherapy
12. Inhalation Therapy
13. Oxygen Inhalation
14. Resuscitation: Mouth to Nose, Mouth to Mouth and other methods
15. Bandages
16. Irrigations and Lavages: Gastric (stomach) lavage, Ostomy Irrigation, Intestinal Irrigation, Irrigation of the Bladder, Irrigation of the Vagina
17. Enemas
18. Urethral Catheterization for Male and Female
19. Injection and Transfusions: Hypodermic Injections, Intramuscular Injections, Hypodermic Infusions



XC-401A



XC-401B

XC - 401

MULTI FUNCTIONAL PATIENT CARE NURSING MANIKIN (FEMALE)

XC - 401-M New

MULTI FUNCTIONAL PATIENT CARE NURSING MANIKIN (MALE)

The model is made of soft and half-hard PVC plastic, solid and durable, easy to use. All joints are movable, can be belt, all parts can be disassembled. It can demonstrate following items:

- | | |
|--|---------------------------------------|
| 1. Washing face and bathing the bed-ridden patient | 12. Abdomen Puncture |
| 2. Care and cleaning of the mouth | 13. Medulla Puncture |
| 3. Care and cleaning of trachea dissection | 14. Lumber Puncture |
| 4. Inhalation of oxygen (nasal cork or nasal catheter) | 15. Deltoid injection |
| 5. Nasal Lavage | 16. Deltoid hypodermic injection |
| 6. Stomach Lavage | 17. Vein injection |
| 7. Heart Infection | 18. Vein puncture |
| 8. Heart resuscitating on chest | 19. Vein transfusion |
| 9. Chest Puncture | 20. Vein blood transfusion |
| 10. Liver Puncture | 21. Urethral catheterization of women |
| 11. Kidney Puncture | 22. Muscular injection on buttocks |

XC - 401
XC - 401-M



XC-408

ELECTRONIC URINARY MODEL

This model can be demonstrated some functions: Catheterization of Male, Catheterization of Female and intestinal irrigation.



XC-408



GD/CPR10280

GD/CPR10280

ADVANCED ADULT CPR TRAINING MANIKIN WITH MONITOR AND PRINTER

This CPR manikin meets AHA (American Heart Association 2015 Guidelines & ECC)

1. In this model there is Light Indicator display for Correct and Incorrect Artificial respiration (Mouth-to-Mouth)
2. There is light Indicator for correct compression position display, wrong compression position display, digital counter.
3. This model simulate the patient revival through first aid by measures of heart pressure and mouth-to-mouth respiration.
4. This model also shows whether the operation is correct or not by light indicator, audio prompting and grade printing.
An ideal model for use in Nursing College, Medical College, Hospitals & Nursing Training Institutes.



GD/CPR10160

GD/CPR10160

ADVANCED CHILD CPR TRAINING MANIKIN

This CPR manikin meets AHA (American Heart Association 2015 Guidelines & ECC)

In this model there is Light Indicator Display for Correct and Incorrect Artificial Respiration (Mouth-to-Mouth), Correct Compression position display, Wrong compression position display.
This model simulate the patient revival through first aid by measures of Heart Pressure and Mouth-of-Mouth respiration.

GD/CPR10150

ADVANCED INFANT CPR TRAINING MANIKIN

This CPR manikin meets AHA (American Heart Association 2015 Guidelines & ECC). In this model there is Light Indicator Display for Correct and Incorrect Artificial Respiration (Mouth-to-Mouth). There is Light Indicator Display for Correct Compression Position Display, Wrong Compression Position Display. This Model Simulate the patient revival through fist aid by measures of Heart pressure and Mouth -of -Mouth Respiration.



GD/CPR10150

GD/CPR10170

HALF-BODY CPR TRAINING MANIKIN

This CPR manikin meets AHA (American Heart Association 2015 Guidelines & ECC)

CPR Manikin feature:

Can perform airway open. Can perform artificial aspiration, judge inflation volume by chest rise. External chest compression, correct compression depth:5-6 cm Correct compression site, prompt correct buzzer sound Excessive compression site, prompt alarming buzzer sound. Operation frequency:> 100#/min, with "tick" sound Power: battery



GD/CPR10170

AED TRAINER / CPR TRAINING MANIKIN (TORSO) FOR MASS EDUCATION

ATX 03 MB001B+ADULT CPR TRAINING MANIKIN (TORSO) (MADE IN SPAIN)

- ▶ The Manikin is the only manikin in the market which includes both Adult and Child CPR simulator in one product.
- ▶ Economics and profitable products.
- ▶ Light weight: 2.2Kg makes easier storing and transport for trainers.
- ▶ The selector on the back allows to chose Adult or Child positions.
- ▶ Adult and Child positions include a clicking sound for checking the correct compression depth according to Guidelines 2015
- ▶ "N" position on the selector allows to check without a clicking sound and without depth limit the acquired skills.
- ▶ The Manikin breathing system is real and exclusive on the market.
- ▶ The Unique valve design allows to be connected nose-mouth-lung.
- ▶ The non-return system of the valve doesn't allow students inhale air from the lung bag helping to avoid Contagions.
- ▶ If the exclusive articulated head is not tilted properly and the nose is not pinched there will be no chest rise.
- ▶ Manikin is essential as complement of the AED trainer (not included).
- ▶ The torso design of manikin and its size is proper to use AED trainer.
- ▶ The Manikin skin material is proper for using AED training pads and easy cleaning.



ATX 04 MB001B +(AD) ADULT CPR TRAINING MANIKIN ADVANCE (TORSO) (MADE IN SPAIN)

MAKE SURE THE VALVE

- ▶ Is correctly assembled.
- ▶ Is correctly attached to the head

MAKE SURE THE LUNG

- ▶ Is Placed on the marks indicated by the adhesive.
- ▶ Rests loosely on the neck.
- ▶ Is not twisted or wrinkled.
- ▶ Is not broken and/or air leaking
- ▶ Is not damp inside.

MAKE SURE THE HEAD

- ▶ Is correctly attached to the two buffers linking it to the torso.
- ▶ Is tilted backwards correctly.

MAKE SURE THE MASK

- ▶ Is correctly attached to the head.
- ▶ Is properly adjusted using the upper tab.
- ▶ Is properly attached to the nose.



MB001 (AD)
CPR Training Manikin Advanced (Torso)

MB001 (AD) same above but without accessories

MB001
CPR Training Manikin (Torso)

MB001 same above but without accessories

PB001
CHILD CPR PRACTI-BABY MANIKIN MODEL MALE
MADE IN SPAIN
FIRST TIME IN INDIA



PRACTI-BABY, THE + LIFELIKE INFANT MANIKIN

PERFORM REALISTIC BREATHING

Practi-Baby's size, weight and movements are suitable for performing correct infant CPR, adapting to training needs.

Exclusive breathing system, including a realistic nose function.

The head tilt enables students to learn the correct breathing technique.



AUDIBLE FEEDBACK

The selector gives the option of practice sessions with or without clicking.

+ STABLE PRACTI-BABY

Stays firmly in position during practice sessions.

AED TRAINING

Pads do not leave residue on the skin.



AED TRAINER / CPR TRAINING MANIKIN (TORSO) FOR MASS EDUCATION

ATX-01 AED Trainer XFT-120 (IMPORTED)

Features & Functions

1. It is Completely Complainant with AHA 2005 (U.S.A.) new guidelines and pre configured with 10 training scenarios that simulate realistic sudden cardiac arrest episodes.
2. With 2 different connectors (Yellow & White) it can be used with real human body, and manikins of used separately both of these two connectors can give responses to check if the pads connections are firm or poor.
3. It includes the DC and AUDIO interfaces ,the former can connect the adapter (that's to say, XFT@AED Trainer can be operated by not only batteries but also the adapter) while the later AUDIO OUT can Connect the speakers .It's very helpful for instructors during teaching.
4. It can be set bilingual, any language is available.
5. Remote Control.



ATX 01

ATX-02 AED TRAINER XFT-120 WITH CPR TRAINING MANIKIN (TORSO) MB-001

This is a combination pack of above ATX-01 AED Trainer + MB-001 CPR Training Manikin (Torso) in a combo pack

2 extra pcs of Lungs included FREE



ATX 02



XC-406-5

WHOLE BODY BASIC CPR MANIKIN (FEMALE) WITH MONITOR & PRINTER

This CPR manikin meets AHA (American Heart Association 2015 Guidelines & ECC) simulate the patient revivals through first aid by measures of heart press on the chest and mouth to mouth respiration. As soon as the patient revivals, his neck artery and heart recover pulsate continuously, his enlarged pupils shrink to normal. the model also shows the operation is correct or not by signal indication, language indication and grade printing. An ideal model for use in hospitals medicals colleges and schools.

XC-406-2

WHOLE BODY BASIC CPR MANIKIN (MALE) WITH MONITOR & PRINTER

This CPR manikin meets AHA (American Heart Association 2015 Guidelines & ECC)

The rest of the specification are same as per XC-406-5

XC-406

WHOLE BODY BASIC CPR MANIKIN (MALE) WITH MONITOR

This CPR manikin meets AHA (American Heart Association 2015 Guidelines & ECC)

The rest of the specification are same as per XC-406-5



XC-404A

KR-190

HALF BODY CPR TRAINING MODEL (MALE)

This Model serves as ideal Training aids for teaching and Training CPR skills in Hospitals, Medical College and Schools. Function: Heart pressure and mouth to mouth respiration.

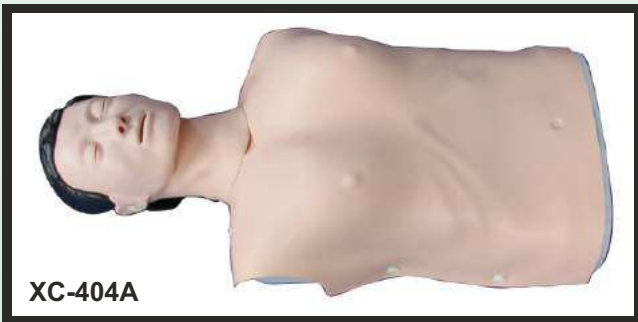

XC-404B

HALF BODY CPR TRAINING MODEL (FEMALE)

This Model serves as ideal Training aids for teaching and Training CPR skills in Hospitals, Medical College and Schools. Function: Heart pressure and mouth to mouth respiration .



XC-404

KR-15200

BASIC CPR MANIKIN (HALF BODY) WITH MONITOR

This manikin shows the half body from the head to the sixth rib of the chest. The cross-section is painted with different colors to show the different organs clearly and vivid. The cross section heart and lung show the various movements when demonstrate heart pressure and mouth to mouth respiration or mouth to nose respiration.

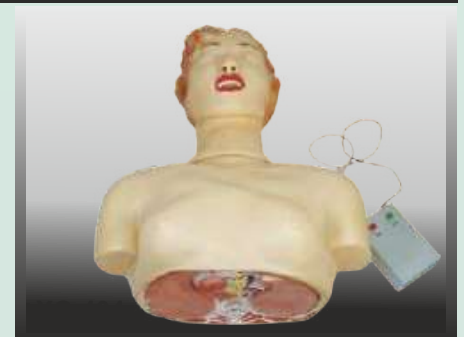

IMPORTED NURSE TRAINING MODELS

GD/A18212

New

HEAD AND NECK WITH BLOOD VESSELS, NERVES AND BRAIN MODEL

Separated into 19 parts, such as:
 Mimic muscular system with the deep-set muscles
 Left temporomaxillary articulation
 Sternocleidomastoid muscle
 Carotid trigone
 Trapezium muscle
 Pectoral major muscle
 Deltoid muscle
 Clavicle
 Eyes with muscles and nerves
 Cranium
 Brain with arteries
 Size : 34x37x20.5cm
 Material: Advanced PVC



GD/A13013

New

TRANSPARENT LUNG, TRACHEA AND BRONCHIAL TREE WITH HEART MODEL

The model consists of heart, great vessels (aorta, superior vena caval), tracheobronchial tree and mediastinum.
 57 positions are displayed
 Size: 2/3 time of Large size, 27x22x19cm
 Material: Advanced PVC and paint
 G.W.: 2.3 kg.

GD/HS12

New

INTRADERMAL INJECTION ARM MODEL SIZE

64x14x10.5cm

Features 8 positions for intradermal injection

GD/HS17

New

INSULIN INJECTION PAD MODEL

The pad is made of imported plastic material with soft and elastic skin and cloth elastic can be worn on the specific site of the patient for self-injection of insulin drug. Such as: abdomen, thigh, upper arm, etc. The length and tightness can be adjusted. And the thickness of the pad is suitable for different specifications of injection syringe. The hard plate in the back would prevent wearing situation of pad.



GD/F55 **Advanced Delivery & Maternal & Neonatal Emergency Simulator :**
Automatic Birthing System, Simulates Real Delivery Process with CPR of Pregnant Women

Advanced Delivery and Maternal and Neonatal Emergency Simulator is a comprehensive education system, which consists of a delivery maternal manikin and a normal newborn, according to the basic requirement of obstetrics, providing a complete birth experience and emergency skills operation. Simulator features includes automatic delivery system, fetus and placental expulsion, prenatal cervix examination and postpartum episiotomy, prenatal gravida and fetus and postpartum maternal and neonatal care, removable stomach cover, multiple fetal heart sounds auscultation and CPR operation etc. The Model is made of High Quality PVC Material. The stomach wall is injection – molded. Perineum is made of sponge emulsion material, features soft texture, good flexibility, realistic operation, reasonable structure and durability. It is one of the ideal teaching aids for clinical obstetrics practice Training.

Product Features:-

- 1) Advanced Delivery maternal manikin can practice Maternal Care.
- 2) Life-Size Maternity, soft and removable stomach cover can be replaced for a auscultation stomach cover and c-section stomach cover.
- 3) Maternal Tracheal Intubation.
- 4) **Automatic Birthing System To Simulate The Entire Birthing Process.**
 This Model Simulate's Normal Delivery process via occiput right interior position; demonstrate engagement – descent –M flexion – inner rotation – extension – reset and external rotation – fetal shoulder expulsion etc. This model can also simulate difficult labor and midwifery course. Simulate normal and abnormal fetal position (Head Birth and Breech Delivery).
- 5) Can carry out Multiple Fetal Heart Sound Auscultation
- 6) Provides Prenatal Cervix Examination; Simulate 6 Stages of Cervical Dilation
- 7) Can Measure Fetal Head Descent and Cervical Dilation.
- 8) Simulate Normal Placenta location, multiple placenta locations and placenta chips residue
- 9) Vulval incision and suturing modules can be inserted into perineum to practice perineotomy, suturing and wound nursing after perineotomy.
- 10) Postpartum Uterine bleeding and Fundal massage.
- 11) Venous Injection on maternal Arm, Drug Treatment and liquid infusion.
- 12) Maternal carotid artery pulse.
- 13) Maternal blood pressure measurement.
- 14) Maternal CPR.
- 15) Articulating Normal Birthing Baby with umbilical cord and normal placenta, life size. Can practice umbilical cord ligation and placental expulsion.
- 16) Neonatal transfusion simulator, providing Newborn Baby Nursing, Tracheal intubation, Venous Injection.

GD/F55 PRICE ON REQUEST



IMPORTED NURSE TRAINING MODELS

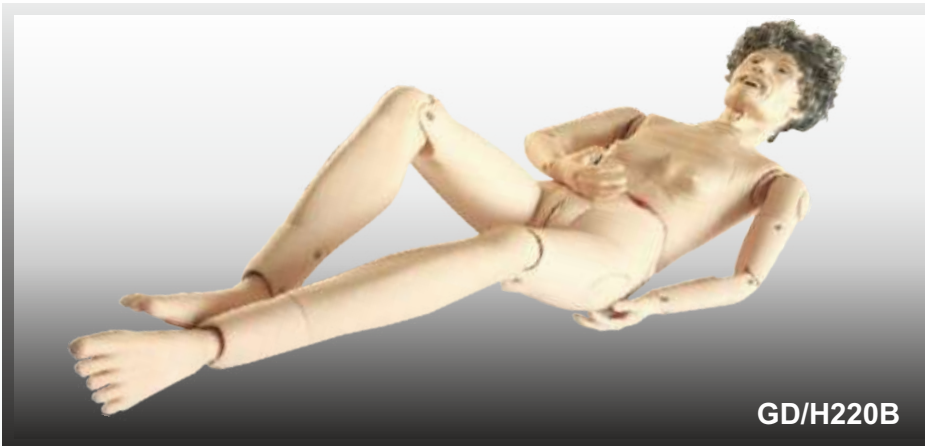

GD/H220B



GD/H220B ADVANCED ELDERLY FULLY-FUNCTIONAL NURSING MANIKIN (FEMALE)

GD/H220A ADVANCED ELDERLY FULLY-FUNCTIONAL NURSING MANIKIN (MALE)

Multi-functional Old Female Lifelike Manikin. Specifically Designed For Professional Nursing Training. High Quality Manikin Provides Wide Range Of Exercise Possible Including Both First And Emergency Situation.

NURSING SKILL:

1. Hair and Face Washing
2. Pupil Observation, Bilateral Pupil States: Normal, Mydriasis
3. Eye and Ear Washing and Administering
4. Removal and Insertion of Hearing Aid
5. Oral Cavity and Artificial Teeth Care
6. Endotracheal Intubation, Automatically Monitor Weather The Tracheal Intubation Is Correct Or Not Through Sensor, Support Auscultation to Detect Intubation Site.
7. Incision Of Trachea Nursing
8. Sputum Suction
9. Oxygen Inhaling
10. Oral and Nasal Feeding
11. Gastrolavage
12. Venipuncture, Injection, Transfusion (Arm)
13. Deltoid Subcutaneous Injection
14. Thoracic Cavity, Abdominal Cavity, Liver, Bone, Marrow and Lumbar Puncture
15. Breast Nursing, Mammary Gland Examination
16. Enema
17. Female Urethral Catheterization
18. Female Bladder Irrigation
19. Stoma Drainage
20. Colostomy
21. Buttocks Intramuscular Injection
22. Large Area Of Sacral Ulcer
23. Cancer Tumor Contrast
24. Cleavage Lines Contrast
25. Holistic Nursing: Sponge Bath, Replacing Clothes Cold and Hot Therapy
26. Realistic Limbs Joint, Stiff Simulative Joints
27. Truck May Lean Forward, Can Sit It The Wheelchair
 - a. Truck-Rotation, Flexibility
 - b. Neck-Rotation, Flexibility, Lateral Crvature
 - c. Shoulder and Buttock-Endoduction, Abduction, Rotation, Flexibility
 - d. Elbow-Internal Rotation, External Rotation,
 - e. Knee-Internal Rotation, External Rotation
 - f. Wrist-Internal Rotation, Flexibility, Stretching, Bending
 - g. Ankle-Introversion, Eversion Endoduction, Abduction
28. Non-Invasive Blood Pressure Measurement
 - a. Systolic and Diastolic Pressure May Be Set Individually In Steps Of 1 MM Hg.
 - b. Systolic Pressure 0-300MM Hg, Diastolic Pressure 0-300Hg
 - c. Korotkoff Sound Volume In Ten Steps, 0-9

This Manikin helps nursing students to understand old age people while nursing.

GD/FT334

FULL-FUNCTIONAL FIVE YEARS-OLD CHILD NURSING MODEL (NURSING, CPR)

General Care: Skin care (e.g.: wear and change clothes), mouth care, ear irrigation, bandaging training, changing diapers, cold and hot therapy; Venous puncture/transfusion: dorsal vein of hand femoral vein, dorsal vein of foot intramuscular injection: bilateral deltoid, bilateral vastus lateralis Subcutaneous Injection: the subcutaneous of lateral thigh Bone marrow puncture: distinct body marks; practice tibial puncture; outflow of simulative bone marrow shows proper puncture operation.

Gastric intubation: detect tube position by means of abdominal auscultation; can practice gastrointestinal decompression, gastric lavage, etc; aspiration of gastric fluid indicates proper intubation; Urethral catheterization: replaceable male/female perineum, practice male/female urethral catheterization. Leum, rectum, bladder stoma care CPR operation training: Support multiple ventilation ways: mouth to mouth mouth to nose, BVM to mouth; electronic monitoring of inflation frequency, volume, compression number, frequency and depth; can only practice inflation or compression. Auscultation: the heart sound, the breathing sound, the bowel sound.

Defibrillating and pacing: simulating the defibrillation and pacing, can be used with different real defibrillator and pacemaker to achieve the real defibrillation and pacing.

ECG: simulating ECG, can be used with different real ECG to achieve the real ECG.





**GD/F5N
IUD TRAINING MODEL**

- Basing on real anatomy of female genitalia, we designed this model for instructing or training of insertion or removal IUD.
- The uterus is in coronal section and covered with transparent plastic window. So students can directly observe the entire insertion or removal process.

**GD/A42010/1
HUMAN PLACENTA
MODEL**

- Mounted on stand
- Made of Advanced PVC
- Shows the Structure of placenta and the relation between placenta and umbilical cord
- 7 Positions are displayed

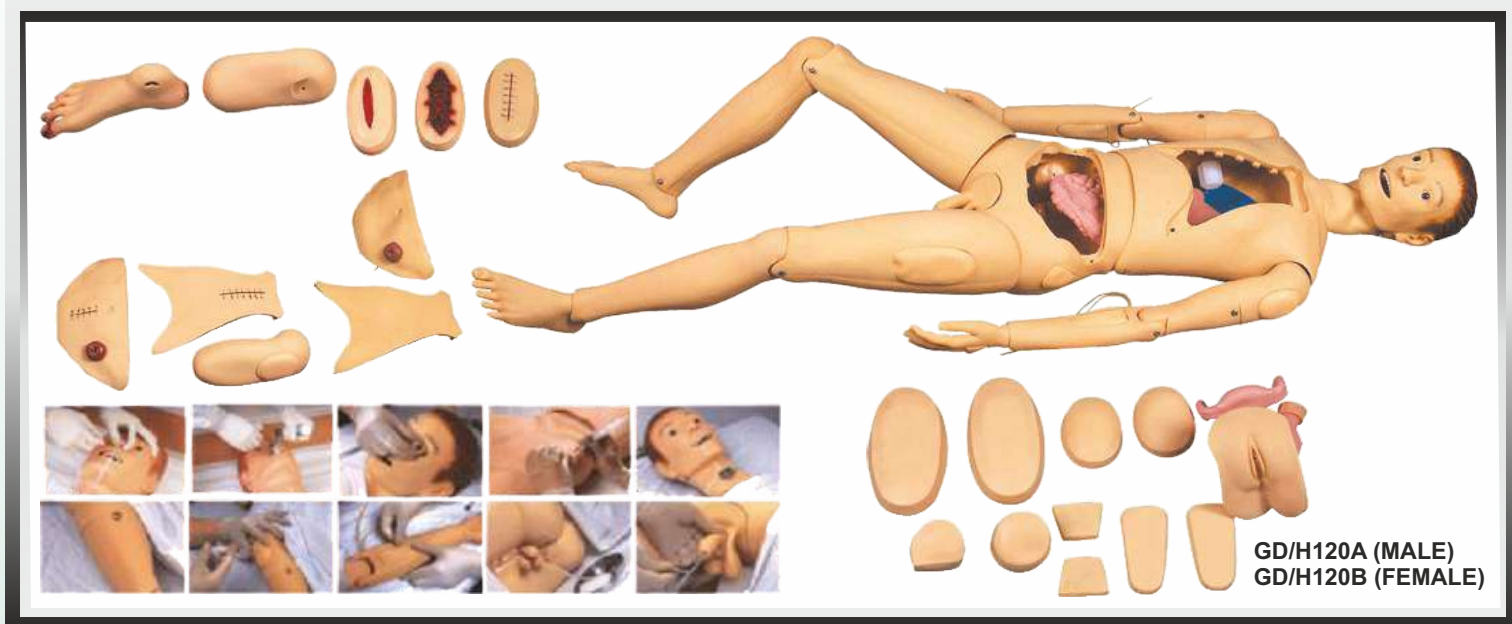

GD/H120A ADVANCED NURSING & WOUND CARE MANIKIN (MALE)

GD/H120B ADVANCED NURSING & WOUND CARE MANIKIN (FEMALE)

Full Body Lifelike UNISEX Manikin. Specifically Designed For Professional Nursing Training.

High Quality Manikin Provides Wide Range of Exercise Possible Including Both First And Emergency Situation.

NURSING SKILL:

1. Hair and Face Washing, Hair Combing
2. Eye and Ear Washing and Administering
3. Mouth Cavity and Artificial Teeth Care
4. Endotracheal Intubation
5. Sputum Suction
6. Oxygen Inhaling
7. Oral and Nasal Feeding
8. Gastrolavage
9. Main Organs In Thoracic Cavity
10. Venipuncture, Injection, Blood Transfusion (Arm)
11. Deltoid Subcutaneous Injection
12. Vastus Lateralis Injection
13. Thoracic Cavity, Abdominal Cavity, Liver, Bone Marrow and Lumbar Puncture
14. Enema
15. Female Urethral Catheterization
16. Male Urethral Catheterization
17. Female Bladder Irrigation
18. Male Bladder Irrigation
19. Ostomy
20. Buttocks Intramuscular Injection
21. Main Organs In Abdominal Cavity
22. Holistic Nursing Care: Sponge Bath, Replacing Clothes Cold and Heat Therapy
23. Limbs Joints: Bend, Rotation and Upper Or Lower Movement
24. Trauma Evaluation and Care: Washing, Disinfection, Enswathing Of The Wound; Hemostasis and bandaging.

IMPORTED NURSE TRAINING MODELS

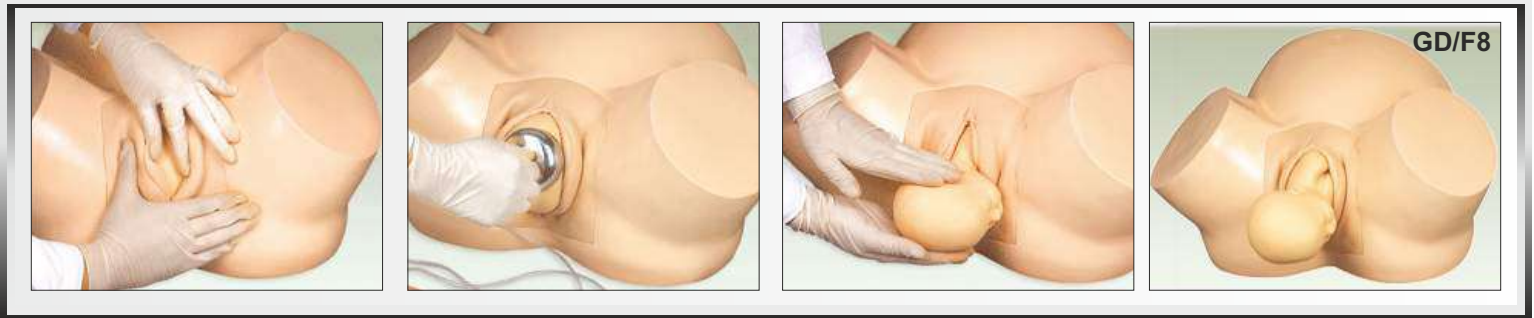

GD/F8

MIDWIFERY TRAINING SIMULATOR

1. This simulator can help to demonstrate all the process of delivery.
2. The life-size pelvic cavity has main anatomical structures.
3. it can help train the skills of Delivery.

GD/H130

ADVANCED NURSING BABY UNISEX

Specifically Designed for Professional Nursing Training. High Quality manikin provides wide range of exercises possible including both first aid and emergency situations.

NURSING SKILLS:

1. Head Neck and Limbs Can Be Moved Freely.
2. The Chest Skin Can Be Replaced
3. Cephalic Venipuncture
4. Umbilical Venipuncture
5. Oral and Nasal Intubation Nursing
6. Care Of Gastrolavage, Enema and Urethral Catheterization
7. Ostomy
8. Deltoid Subcutaneous Injection and Buttocks Intramuscular Injection
9. Holistic Nursing Care: Sponge Bath, Replacing Clothes, Lactation and Diaper Changing

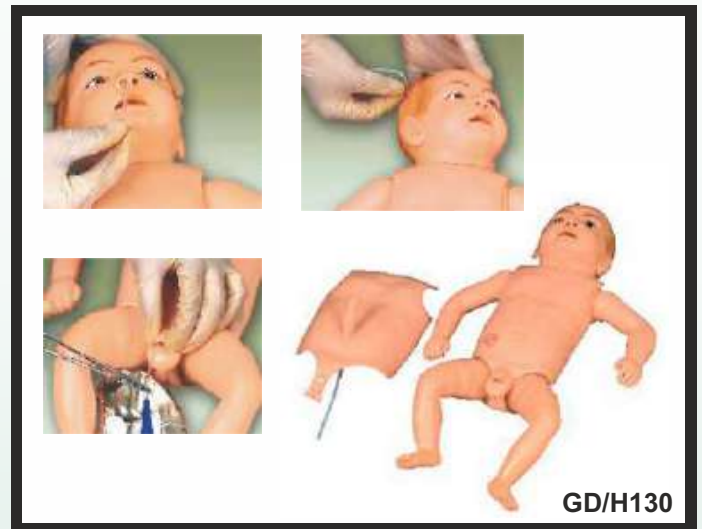

GD/H130

GD/F30S



GD/F30S

GYNECOLOGICAL EXAMINATION MODEL

This Gynecological Training Model is specifically designed for professional training. The various functions of this model are as follow:

1. Palpation of normal and pregnant uterus.
 2. Bi-manual pelvic tri-manual pelvic examination.
 3. Vaginal examination.
 4. Visual recognition of normal and abnormal cervixes.
 5. Contraceptive sponge insertion and removal.
- Observation of uterus, ovary, fallopain tubes and ligament teres.

GD/A42007

DEMONSTRATION MODEL OF CHILD BIRTH

1. This Model Shows the Delivery procedure
2. Consists of Uterus, Fetus, Placenta



GD/A42007

GD/F20

CHILD BIRTH SKILL TRAINING SIMULATOR

This model consists of pelvic, fetus (with umbilical cord and placenta), cervix check model (cervix change of antepartum) perineum cutting, and suturing training simulator and etc. with lifelike shape, cervix check and childbirth procedure can be operated. Trainees can simulate proper childbirth procedure, assist delivery, perineum protecting, and episiotomy.

Features:

- Cervix check model: Size of cervical ora, effacement of cervical canal and the position of fetal head corresponding to the plane of ischial can be checked.
- Fetus model: The skin is soft and fontanel is visible. Vacuum extraction, umbilical cord ligation, and placenta expulsion can be exercised.
- Childbirth model: The model consists of transparent abdominal wall and lifelike skin. Simulate normal or difficult labors, assist delivery, and perineum protecting.
- Perineum cutting and suturing training simulator: The simulator can be used repeatedly. One set of the simulator consists of three components; separately simulate the right posterior, left posterior incision or median incision.

GD/F35

ADVANCED GYNECOLOGICAL TRAINING SIMULATOR

Features:

- It is including all the functions of GD/F30S.
- Hysteroscopy checking
- Laparoscopic visualization checking, can observe the Uterus, accessories, round ligament, uterine and other structures
- It can place the female condoms, contraceptive sponge, cervical cap and other contraceptives.
- Cervix, uterus can be replaced

Components:

- The normal and abnormal uterus and accessories model can be bimanual and triple diagnosis checking
- Normal uterus and accessories (the front uterus wall is transparent, so the IDU can be placed and took out.)
- Normal uterus and accessories
- Uterus associated with significant flexion, forward.
- Uterus associated with significant back flexion, back forward.
- Uterus associated with right ovarian cysts tubal
- Uterus associated with right tubal cyst.
- Uterus associated with right hydrosalpinx
- Uterine fibroids
- Uterine inflammation associated with the right accessories
- Uterine malformations.
- Normal and abnormal cervix model
(It is used for checking the parts by gynecatoptron)
- Normal cervix
- Chronic cervicitis
- Acute cervicitis

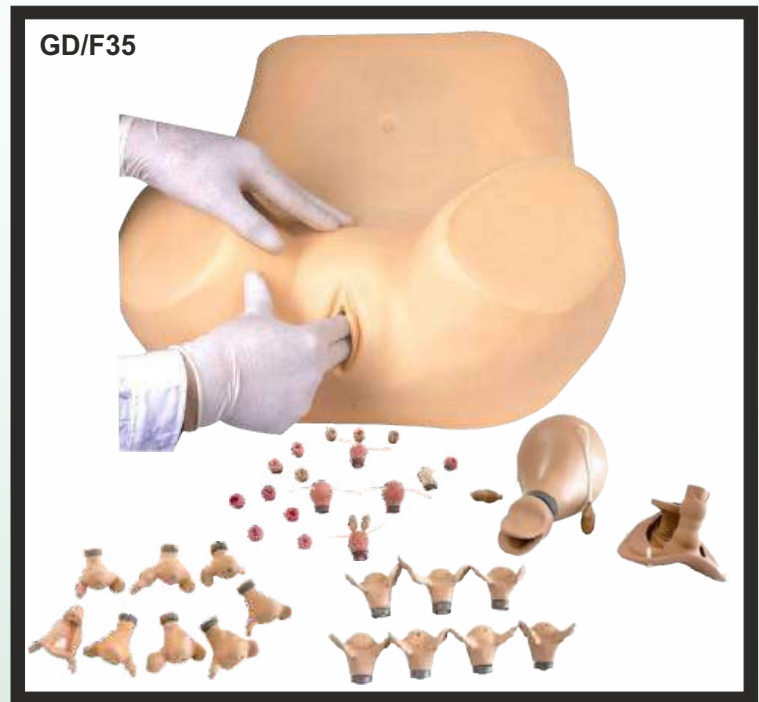
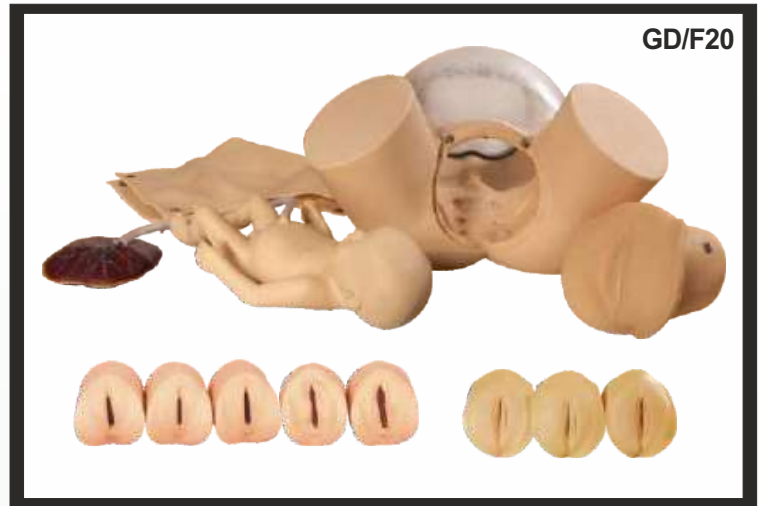

- Cervical cyst
- Inflammation Bohnert
- Cervical polyps
- Cervical adenoma
- Normal uterus
- Endometrial polyps
- Endometrial hyperplasia
- Uterine fibroids
- Early uterine body cancer
- Advanced uterine body cancer
- End uterine cancer
- Pregnant uterus model
- 6-8 week of pregnancy the uterus
- 10-12 week of pregnancy the uterus
- 20 weeks week of pregnancy the uterus
- Simulation of post partum 48 hour uterus
- The process of placing and taking out the IDU

IMPORTED NURSE TRAINING MODELS



GD/F7A/XC 418 BREAST EXAMINATION MODEL

1. Palpation of galactophore malignant tumor, Innocent tumor, lymphaden and lobulus accrementition.
2. In Imported thermoplastic.
3. Lifelike shape, skinny, pleasant to touch and durable.
4. Ametabolic under disinfections and cleanout, convenient delivery.



GD/FW2, XC 412 MATERNITY EXAMINATION MODEL

Specifically deigned for professional training. The various functions of this model are as following:-

1. Palpation, embryo heart sound auscultation, pelvic measurement and mammary nursing training.
2. Inflating uterus through ball to make model to lifelike. Adjustable heart sound speed, volume.
3. Heart sound can be heard not only from stethoscope but also from microphone of front board of model.

GD/L63 PROSTATE INSPECTION MODEL

This model provides prostates with tumors in 4 different development periods.

- The 1st development: Begin, slightly enlarged, but normal prostate gland simulates benign stage.
- The 2nd development: Some hard tubers can be observed in the top right quadrant of prostate. It's the beginning of the tumor.
- The 3rd development: Prostate with easily palpable large mass simulate intermediate stage. The small module has increased is size and has become an external hard mass on the surface of the gland.
- The 4th development: Prostate with malignant invasive cancer simulate terminal stage. This gland is totally replaced with carcinoma. The entire gland will feel hard and irregular.



GD/H70-1 NASOGASTRIC FEEDING & TRACHEAL INTUBATION SIMULATOR

Hair and Face Washing, Eye and Ear Washing and administering Mouth Cavity Care, Endotracheal Intubation
Oxygen Inhaling, Nasogastric Intubation
Sputum Suction, Oral and Nasal Cavity Intubation
& Carotid Artery Pulse



GD/H90E DECUBITUS ULCER CARE SIMULATOR

4 Stages of Ulceration. Decubitus ulcer kinds: sinus, fistula, corruption scab, infection, bone exposure, eschar, suturing incision, Herpes and Monilia infection. Incision washing, evaluation and measurement



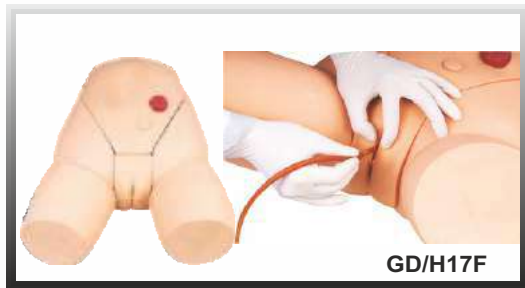

GD/H17F

GD/H17F

FEMALE CATHETERIZATION TRAINING SIMULATOR

- General urethral catheterization process can be operated.
- There are resistance when advance the catheter through urethral sphincter. Features same as GD/H17F.

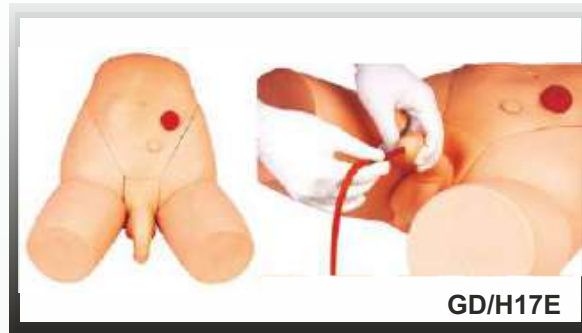

GD/H17E

GD/H17E

MALE CATHETERIZATION TRAINING SIMULATOR

- General urethral catheterization process can be operated.
- General urethral catheterization process can be operated.
- There are resistance when advance the catheter through mucosal fold, bulb of urethra and intraurethral sphincter. Features same as GD/H17E.

GD/F20G

LABOUR DELIVERY MODEL

- This Model consists of six development phases and each part shows a state of prenatal cervix and birth canal. The whole model demonstrates the relations between the scope of expanding of the orifice of cervix and the range of cervical tunnels, as well as the relation between the position of the head of fetus and the square of ischial spine.
- 1st: The orifice of cervix has no expanding and the cervical tunnels haven't disappeared at all. The positional relation between the head of fetus and the square of ischial spine is -5.
- 2nd: The orifice of cervix has expanded 2cm bigger and cervical tunnel disappear 50%. The positional relation between head of fetus and the square of ischial spine is -4.
- 3rd: The orifice of cervix has expanded 4cm bigger and the cervical tunnels disappear absolutely. The positional relations between the head of fetus and the square of ischial spine is -3.
- 4th: The orifice and cervix has expanded 5cm bigger and the cervical tunnels disappear absolutely. The positional relation between the head of the fetus and the square of ischial spine is 0.



GD/F20G



GD/J112

GD/J112

New

STANDARD PATIENT FOR EXTERNAL FIXATION TRAINING SIMULATION IN FIRST AID OF LIMB FRACTURE

Made of imported silicone rubber material after injection molding. Can simulate trauma of head and limbs closed fracture. Can help students understand fracture symptoms such as deformity, bone fricative and abnormal movements and carry out diagnosis and treatment. Can help the trainee master clearing, disinfection, binding up, fracture reduction and fixation and handling operation of fracture trauma in practice. Has great clinical significane in surgical trauma emergency skill training. Vivid fracture trauma simulation. Modular accessories can be replaced conveniently. One of ideal products for surgical trauma emergency rescue skills training. Suitable for practice training in medical colleges, nursing colleges and training teaching in clinical popularization among primary level health departments.



IMPORTED NURSE TRAINING MODELS

GD/F52

ADVANCED DELIVERY MECHANISM DEMONSTRATION SIMULATOR

Features:

- Demonstrate the whole process of delivery.
- Demonstrate the fetus, umbilical cord and placenta of vacuum-assisted delivery, flexible fetal joint and multiple normal and abnormal positions of fetal delivery can be showed.
- Can practice and master the comprehensive skills of normal labor, abnormal labor (dystocia), midwifery, and perineum protection.
- Available Training of multiple pregnancy (twin pregnancy).
- Component: A (Matrix for delivery Demonstration) + B (Fetus for Demonstration).

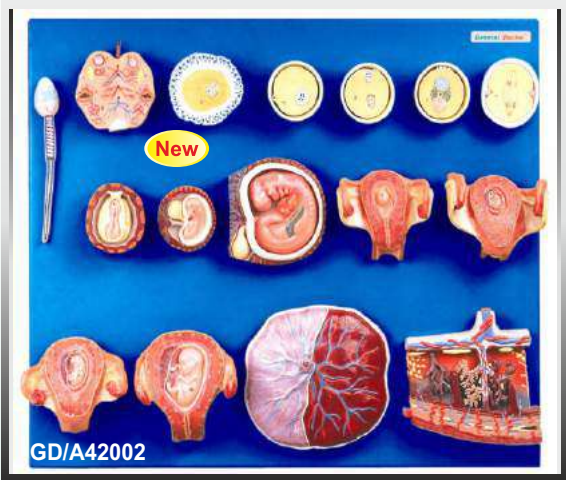
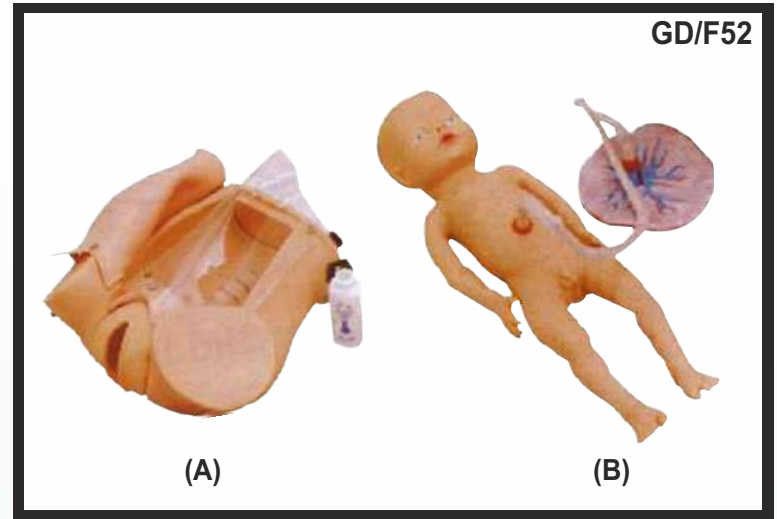

GD/A42002

HUMAN FERTILIZATION AND EARLY EMBRYOLOGY MODEL

Shows the development from ovum to the fetus in third month.
16 positions are displayed.
Material: Advanced PVC

GD/A42001

FERTILIZATION PROCESS SIMULATOR Shows two frontal sections through female genital organs. Mounted on a board. 25 Positions are displayed.



GD/F9G New

VASOLIGATION TRAINING SIMULATOR

Accurate anatomic structure. Can touch the vas deferens on the upper end of the testis. Training practice can be done in the classic way to cut off or ligate the vas deferens to block the output of sperm and ensure sterilization. Training practice can also be done as per new technology: No scalpel vasectomy (NSV), to block the output of sperm and ensure sterilization. Provide easily replaceable genital parts (including two pieces of testis and mobile scrotal skin and two pieces of vas deferens). Can be used repeatedly in training practice.

! BEWARE, CAUTION !

BEWARE OF POOR QUALITY MATERIAL & IMITATIONS. INSPITE OF THE FACT THAT WE ARE THE LARGEST SUPPLIER OF NURSING TRAINING MODELS, MANIKINS, SIMULATOR & DEVICES. WE ARE FACING SOME UNETHICAL & UNFAIR COMPETITION FROM FLY BY NIGHT SUPPLIERS WHO ARE ADVERTISING OUR PRODUCTS, USING OUR PRODUCT PICTURES ONLINE LIKE INDIA MART, AMAZON, FLIPKART & OTHER SMALL TIME LOCAL DEALERS WITH CATALOGUES/LEAFLETS OF 2-3 PAGES AT LOWER PRICES BUT AT THE SAME TIME THEY ARE SUPPLYING PRODUCTS OF INFERIOR QUALITY, MADE OF RECYCLED RUBBER OR CLAY, EVEN SUPPLY IMITATIONS MADE LOCALLY, WHICH WILL NEVER HELP STUDENTS TO ACQUIRE SUPERIOR PATIENT CARE SKILLS. WHEREAS OUR TRAINING DEVICES, MODELS, MANIKINS, SIMULATORS FROM NASCO, VIMETESCA, XC, GENERAL DOCTOR ETC. ARE OF VERY HIGH LEVEL OF ACADEMIC WITH ABILITY TO IMPLEMENT NEW IDEAS USING STATE OF ART EQUIPMENT & TECHNIQUES, THE MATERIAL USED BY LOW COST SUPPLIERS MAY BE HAZARDOUS & THE PRODUCT MAY BE INACCURATLY DESIGNED & MAY TURN OUT TO BE DANGEROUS FOR YOU AND YOUR STUDENTS.

GD/FT333

ADVANCED MULTI-FUNCTIONAL CHILD NURSING MANIKIN (UNISEX)

Designed according to the anatomical characteristics of child, and specializing in child care training. The skin is soft and flexible. not easily deformed, realistic shape lovely appearance, and clear internal anatomical structure. Good help for pediatric nursing teaching and training.

NURSING SKILLS:

1. Pupil observation. Bilateral Pupil states: normal, mydriasis.
2. Operations of child care: full body bandage exercise, bathing, changing clothes, hair combing, eye washing and administering, otic drops and irrigation, mouth cavity care, blood collection of finger and TB test.
3. Airway administering: realistic mouth, nose, tongue, gum, pharynx, larynx, esophagus, epiglottis, trachea and tracheal ring, can practice tracheal intubation, sputum suction, oxygen inhaling.
4. Oral and nasal feeding
5. Gasrolavage
6. Venipuncture, injection. transfusion (arm). When needle penetrates into vein Blood flash back indicates proper insertion.
7. Intramuscular injection in bilateral deltoid, bilateral vastus lateralis and bilateral buttock
8. Enema, placement of rectal supposition
9. Urethral catheterization
10. Holistic care: sponge bath, replacing clothes, cold and heat therapy
11. Limbs joints: Bend, rotation, upper and lower movement.
12. Bathing and bandaging activity
13. Ostomy nursing of ileum. colon and bladder.
14. Tibial bone marrow puncture: Simulated bone marrow would outflow in the case of correct puncture.



GD/FT333

GD/FT335

ADVANCED FULL FUNCTIONAL NEONATAL NURSING & CPR MANIKIN

1. General care: change diapers, change clothes, mouth care, cold and hot therapy, bandaging;
2. Venous transfusion/puncture, arm veins include and Scalp vein includes.
3. Umbilical cord care: ligature of umbilical cord, umbilical venous intubation and transfusion;
4. Gastric intubation: detect tube position by means of auscultation; can practice gastrointestinal decompression, nasal feeding, gastric lavage, etc;
5. Bone marrow puncture: practice tibial puncture; outflow of simulative bone marrow shows proper puncture operation; drug liquid can be injected into and can practice transfusion operation;
6. CPR operation training: Supporting multiple breathing ways by mouth to mouth, mouth to nose and simple respirator to mouth; electronically monitor compression; frequency and volume of blowing, compression times, frequency and depth, blowing and compression can be training separately.



GD/FT335

GD/F3A

New

PERINEUM CUTTING AND SUTURING TRAINING MODEL

This model is designed for practice of perineum cutting and suturing. The main structure of the simulator is a perineum, which is made of simulative foam, and the inner muscle is soft PVC. The simulator is mounted on a plastic framework.

There are two handles in the back and bottom of the simulator to adjust tension of the perineum. Right posterior incision, left posterior incision or median incision can be selected to exercise perineum cutting and suturing. Size: 36x34x26cm G.W. : 2 kg.



GD/F3A

IMPORTED NURSE TRAINING MODEL

GD/AED99D+

AED SIMULATOR AND CPR MANIKIN SET

This manikin is suitable for BLS (Basic Life Support) and AED (Automated External Defibrillator) training.

1. Opening or closing the cover will turn on AED instrument.
2. Simulate first-aid procedure: GD/AED99D (only for training use) has not high tension shock motion.
3. Automatically check the position of electrode pad.
4. There are 9 internal scripts, simulating different conditions.
5. Simulate: touch the patient's body when conducting AED; the position of electrode pad is wrong or right; it is need to defibrillate or not; machine has trouble; the electricity is low
6. Electricity management function: The system automatically checks the batteries electricity. When the electricity is low, there will be sound indicating. During the interval of two times, system will enter saving power mode. If there isn't operation in 3 minutes, system will enter waiting mode.
7. Lithium battery

Features of half-body CPR manikin:

1. Simulate airway opening
2. External breast compression: sound prompting
3. Artificial respiration: observe the fluctuation of chest (Inhalation standard: =500/600ml-100ml=)
4. Operation frequency: 100 times per minute (the latest international standard)
5. Operation mode: exercise mode



GD/J140

BABY OBSTRUCTION/INFANT C.P.R. SIMULATOR

Full-body lifelike baby specifically designed for professional training of Heimlich manoeuvre, foreign-body airway obstruction feature provide a realistic condition for releasing of a foreign body obstruction through back blows and chest thrust techniques

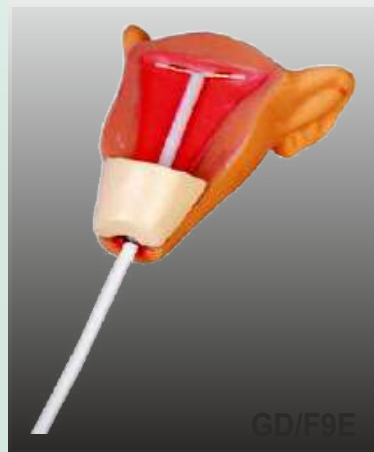

GD/F9E

IUD TRAINING SIMULATOR

Feature:

The model accurately show uterine lateral section, with transparent membrabe covering on the model, can clearly observe IUD insertion and placement process.

GD/F9F

IUD TRAINING SIMULATOR

Feature:

The model accurately show uterine lateral section and internal structure of the internal genital clearly observe IUD insertion and placement process.





GD/J110

ADVANCED TRAUMA CARE MANIKIN

Full-Body Life Like Male Manikin
Specially Designed for Professional Trauma Nursing Care
High Quality Manikin provides wide range of exercises

Trauma Nursing Skills :-

1. Bed Bathes, Dressing and Undressing
2. Hair Washing
3. Face Washing
4. Irrigation of the Eyes and Ears
5. Oral Cavity Care
6. Oxygen Inhalation
7. Nasal Feeding
8. Lavage
9. Oral Cavity Intubations
10. Nasal Cavity Intubations
11. Tracheotomy Care
12. Organs Structure of Thorax
13. Venipuncture and Injection, Transfusion
14. Deltoid Injection
15. Male Urethral Catheterization
16. Female Urethral Catheterization
17. Gluteus Injection
18. Ostomy Irrigation
19. Organs Structure of Addominal Cavity

Trauma Evaluating Modules:-

1. Facial Burns : 1st, 2nd and 3rd Degree
2. Laceration in Forehead
3. The Wound in Jaw
4. Opened Clavicular Fracture and Contusion Wound on the Chest
5. The Wound in Abdomen with Small Intension Evisceration
6. Opened Humerus Fracture of Right Upper Arm
7. Opened Fracture of Right Upper Hand (Including Parenchyma Laceration, Fracture and Bone Tissue Exposure)
8. Gun Wound in the Right Palm
9. Opened Fracture of Right Thighbone
10. Compound Femur Fracture of Left Thigh
11. Metal Pricking Wound in Right Thigh
12. Opened Tibia Fracture of Right Leg
13. Opened Fracture of Right Foot with Truncating Trauma on Small Phalanx
14. Burns in Left Fore Arm : 1st, 2nd and 3rd Degree
15. Truncating Trauma on Left Thigh
16. Closed Tibia Fracture of Right Leg and Confusion Wounds in Left Ankle and Foot

GD/J5S

ELECTRONIC TRACHEA INTUBATION MODEL

- Accurate anatomical marks
- Oral or nasal cavity intubation
- Wrong operation, stomach inflation or laryngoscope compressing the teeth will activate warning prompting
- One proper pupil and another mydriasis

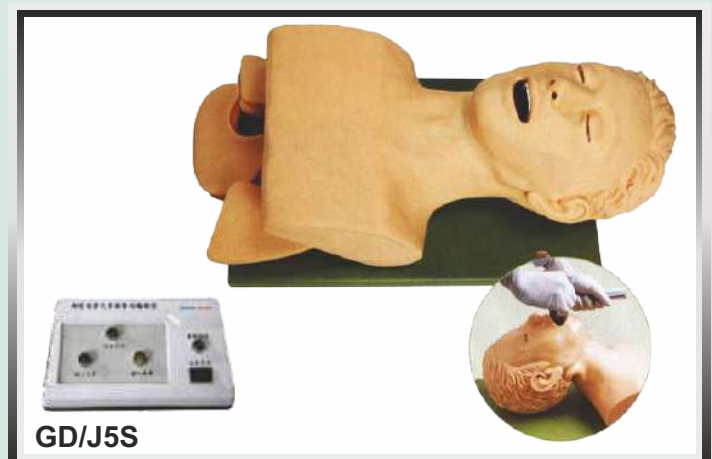

GD/J5S

IMPORTED NURSE TRAINING MODELS

GD/J158-C CPR and Intubation Training Manikin (Adult) with Monitor

Implement standard: AHA (American Heart Association) 2015 guideline for CPR and ECC



GD/J158-C

The model is adult upper body with clear anatomical landmarks (costal arch, xiphoid), easy to operate positioning. The facial skin, neck skin, chest skin, hair are all made of imported thermoplastic elastomer mixed plastic material made of stainless steel mold, the injection molding machine injection pressure from high temperature. It has realistic touch feeling, unified color, realistic shape, nice appearance, high durability, easy disassembly and replacement features.

Features:

1. Pupil response: Bilateral pupils contrast observation;
2. Carotid artery response: pinching pressure the ball to simulate carotid pulse;
3. Chest compressions;
4. Standard airway open;
5. Feasible three ways to open the airway: lift jaw with head back, lift the head and neck, lift jaw by hands;
6. Mouth resuscitation and ventilator-assisted breathing, effective artificial respiration has visible chest rise;
7. Simulate laryngeal mask airway and composite cannula can be inserted into the air way;
8. Verify endotracheal intubation is correct or not: a catheter inserted into the trachea, lungs will swell (plastic bladder) when inflated;
If the catheter is inserted by mistake esophagus, stomach will swell when inflated (plastic pouch).
Observed pulmonary respiration;
9. Artificial ventilation;
10. Oral or nasal intubation and esophageal intubation;
11. Open the air way and practise from resuscitator bag to breathing mask or from resuscitator bag to the cannula;
12. Respiratory tract is simple and can be replaced;
13. Easy to carry, suitable for field training.

GD/F54

ADVANCED ABDOMINAL PALPATION & DELIVERY MECHANISM INTEGRATED SIMULATOR

Features:

- Demonstrate the fetus, umbilical cord and placenta of vacuum-assisted delivery, flexible fetal joint, and multiple normal and abnormal positions of fetal delivery can be showed.
- Equipped with manual delivery mechanical parts; by manual, the whole delivery process, including engagement, descending, flexion, internal rotation, extension, restoration, external rotation and fetal delivery, can be showed.
- Can practice and master the comprehensive skills of normal labor, abnormal labor (dystocia), midwifery and perineum protection.
- Equipped with soft elevated cushion for Leopold Maneuver practice.
- Equipped with models for cervical and vaginal examination practice before and at birth.

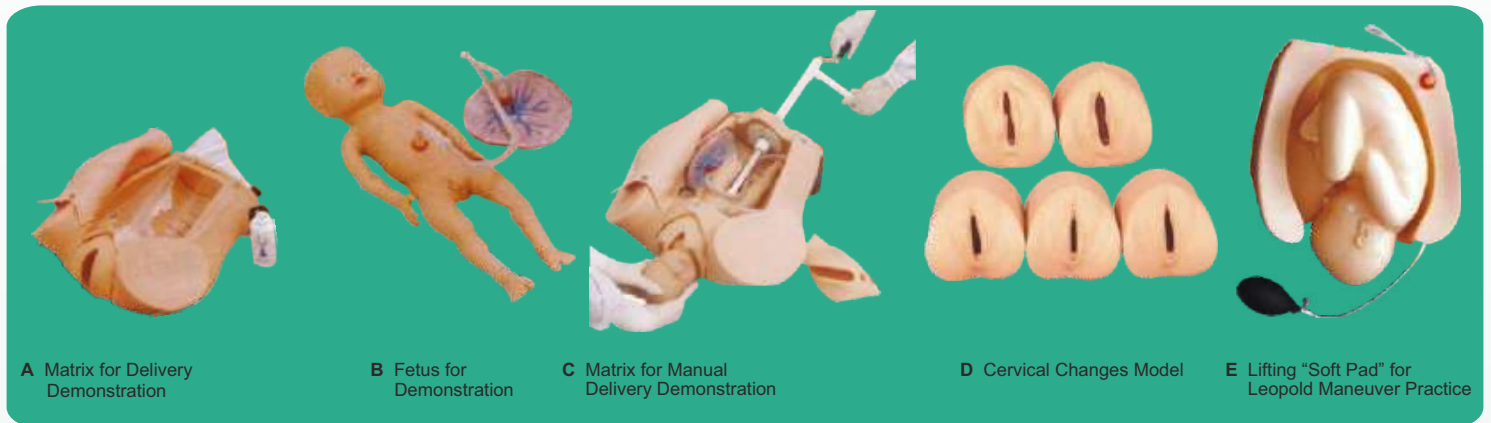

COMBAT ADULT RESCUE MANIKIN WEIGHT 70KG For Rescue Training in Aeroplane emergency / building under fire Made in USA

Developed for lifelike adult or juvenile patient handling, transportation, and extrication training. This manikin can be safely used in situations too hazardous or uncomfortable for human volunteers. Made of tough cast vinyl with zinc-plated steel frame for longevity and rugged use. Manikin is fully articulated for positioning in widely diversified training environments. The manikin can be seated in an automobile, positioned in a smoke-filled room, and immobilized on a stretcher for mountain rescue instruction. Useful for simulating the removal of victims from utility poles, conduits, mine cave-ins, tunnels, and limitless other training procedures. Perfect to use with the Manikin

Named the official manikin of the Firefighter Combat Challenge, this manikin duplicates the weight and resiliency of a human body and features a rust-resistant steel skeleton with cables of 4200-lb. break strength. The manikin is 6 ft. tall and is 70kg. in weight.

This is suitable for Military, Fire Department, Police, Emergency Personals, Disaster Management, Miners, Tunnels & other Hazardous Situations



IMPORTED NURSE TRAINING MODELS

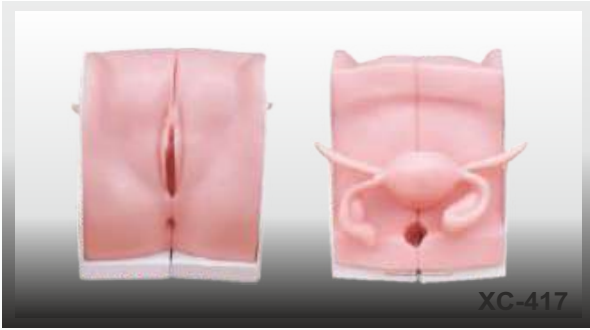

XC-417

XC-417

CONTRACEPTION GUIDANCE MODEL

This model shows the anatomical section of female genitals. It can be demonstrated to put the pessary, how to put contraceptive medicine membrane or table, how to put in a take out the IUD and how to make induced abortion etc.

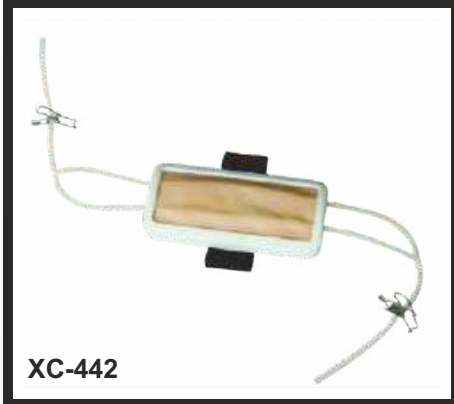

XC-442

XC-442

IV INJECTION PAID

This portable model can be used for injection, blood transfusion and hemospasia training. The skin and blood vessels can be easily replaced.



XC-441A

XC-441A

ELECTRONIC IV TRAINING HAND

This model include mainly vein used for IV injection, blood transfusion and other puncture practices. Alarm system included.



XC-431A

XC-442A

SUTURE PRACTICE PAD

This portable model can be used for suture practice. Skin can be easily replaced.



XC-442A

XC-431A

ELECTRONIC BUTTOCKS INJECTION SIMULATOR

This model based on the normal human anatomy. For students to wear, surface is very similar to a real body. Simulated injection liquid can be injected into it when inject on the correct area. Alarm system included.



GD/HS7

GD/HS7

ADVANCED BLOOD PRESSURE TRAINING ARM MODEL

Features

This Adult Blood Pressure Training Arm lifelike model is designed for training students of Medical colleges, Nursing colleges, Health schools and clinic workers to teach and exercise blood pressure skills. This is a versatile training tool developed to assist health professionals teach the processes and skills required to perform blood pressure auscultation procedures.



GD/HS8

GD/HS8

MULTIFUNCTIONAL CHILD IV TRAINING ARM MODEL

This lifelike child vein puncture and injection training arm has all vena of the vascular system of the arm, it helps to provide a good training of injection, infusion and phlebotomization. This model can provide real life like feel when the students practice on this model.

GD/LV18

SURGICAL SUTURING AND BANDAGING SIMULATOR

The Simulator provides commonly used surgical incisions, which simulate all kind of female thoracic and abdominal incisions, tube drains and amputation stump. Students can practice wounds treatments of washing, disinfecting, changing dressing, bandaging etc. The skin is dry, soft, and flexible, allowing the bandages to adhere better.

Features:-

- Thyroidectomy
- Mid-sternal spilt- with two chest tube drains
- Right mastectomy- with simulated drain
- Right cholecystectomy- with simulated T-tube
- Laparotomy
- Appendectomy
- Left colostomy
- Right ileostomy
- Abdominal Hysterectomy (Transverse incision)
- Left nephrectomy (thoraco- abdominal incision)
- Right nephrectomy (oblique incision)
- Laminectomy
- Sacral decubitus ulcer- stage 2
- Right thigh amputation stump

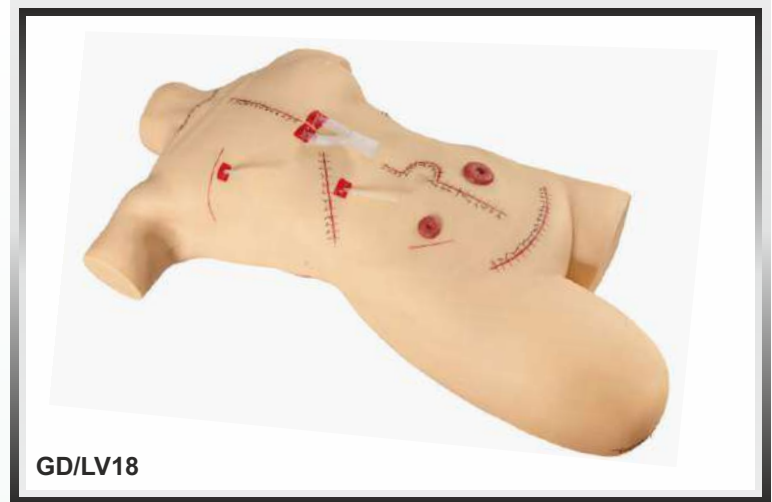

GD/LV18

GD/L69C

PICC LINE (PERIPHERALLY INSERTED CENTRAL CATHETER)

The model is suitable for central venipuncture of internal carotid vein and subclavical vein and peripheric venipuncture (arm veins) of cerhalic vein. The cervical veins and arm veins can be filled with simulative blood

Features:

- The model is a simulative right half of adult torso with right arm. There are apparent anatomical marks: clavicle suprasternal notch, sternocleidomastoid muscle, pectoralis major muscle, ribs and deltoid muscle
- Lifelike veins: Superior vena cava, internal jugular vein, subclavical vein, cephalic vein, basilica vein and median cubital vein etc.
- With apparent anatomical marks, the model can be used to train puncture and catheterization of internal carotid vein, subclavical vein, cerphalic vein and heart catheterization.
- The skin and veins can be replaced; Students will feel an apparent "POP" when puncture needle has been thrust into the veins
- The heart floating swan-ganz intubation can be exercised.

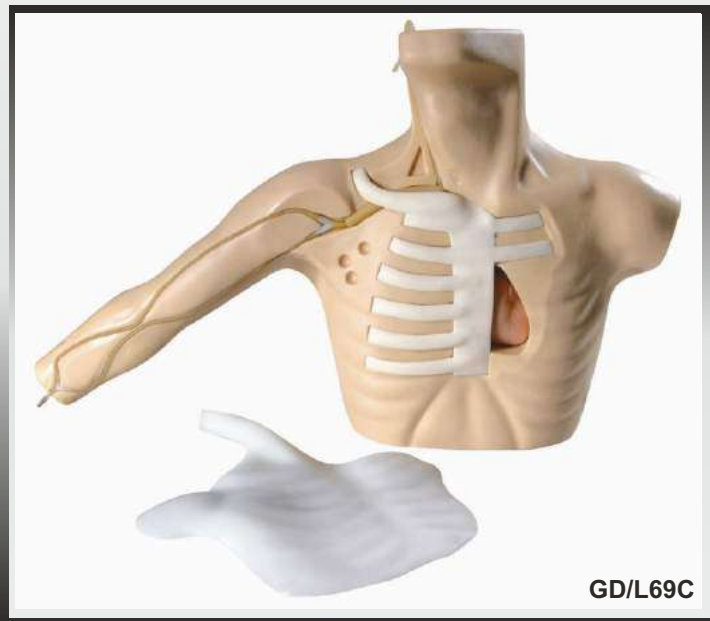

GD/L69C

GD/HS10B

ADVANCED BUTTOCKS INTRAMUSCULAR INJECTION SIMULATOR

Features:

The transparent left side of the model shows internal structure including bones, muscles, nerves and veins, facilitating to compare left side with right side and avoiding damaging the nerves and veins. Correct intramuscular injection sites can be palpated A buzzer and two color flashing lights will warn students if the needle position is incorrect.



GD/HS10B

IMPORTED ANATOMICAL MODELS



GD/A18101

GD/A18101 NERVOUS SYSTEM

- Mounted on board.
- Shows 33 Position
- Show the structure of central nerves, peripheral nerves, including spinal nerves radiated from central system to other parts of body (such as ulnar nerves, radial nerves of brachial plexus, median nerve, ischiadic nerves).
- Made of Advanced PVC.

GD/A18110 SYMPATHETIC NERVOUS SYSTEM

- Mounted on board.
- Shows 53 Position
- Shows the outlook of Automatic Nervous System, including Sympathetic.
- Made of Advanced PVC.

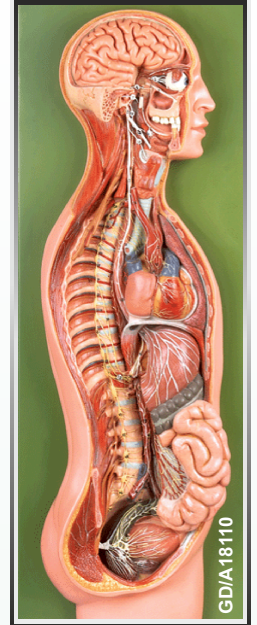

GD/A18110

GD/A16001 CIRCULATORY SYSTEM

- Mounted on board.
- Shows 81 Position
- Shows general network of vessels in human body.
- Made of Advanced PVC.



GD/A16001

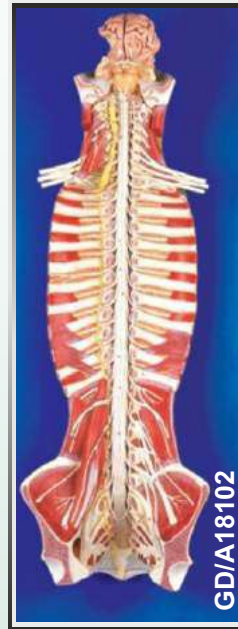

GD/A18102

GD/A18102 SPINAL CORD IN THE SPINAL CANAL

- Mounted on board.
- Shows 47 Position
- Shows Ventral side, Brain Stem and Spinal Cord.
- Branches up to the coccygeal plexus, Sympathetic trunk with its connection to the Central Nervous System.
- Made of Advanced PVC.



GD/A12001

XC-350

GD/A12001 New DIGESTIVE SYSTEM

- Mounted on board
- Shows alimentary canal from mouth to rectum in median section and included buccal cavity, pharynx, esophagus with half of the stomach, the opened duodenum, small and large intestine, the opened appendix, the unfolded return, the transverse colon, liver and pancreas.
- Shows 49 positions.
- Made of advanced PVC.

GD/A16011 LYMPHATIC SYSTEM

- Mounted on board.
- Shows 63 Position
- Shows the component and structure of the Lymphatic System.
- Made of Advanced PVC.

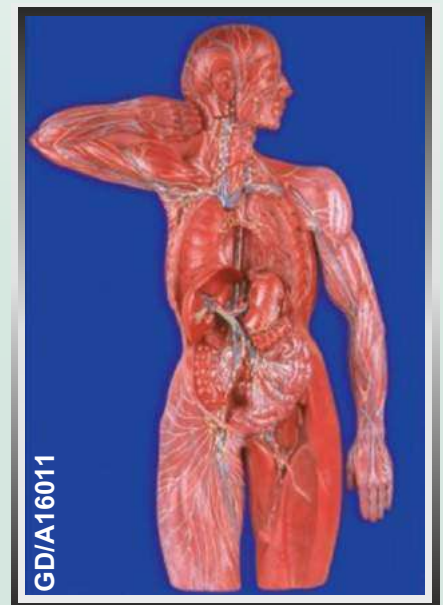

GD/A16011

New

YXH-1A6E

SPINE BOARD (full size)

Spine Board mainly used for safety transporting seriously injured and immobilizing patients. Its structure is allowed X-rays because of its completely translucent. It is compatible with most head immobile devices and strap mechanisms. It also can be used as a floatable device. Packed in high normal brown carton.

Technical Specifications: -

Product size (LxWxH): 184x45x5.5cm

N.W. – 7.4 kg.

Load Bearing : 155 kg.

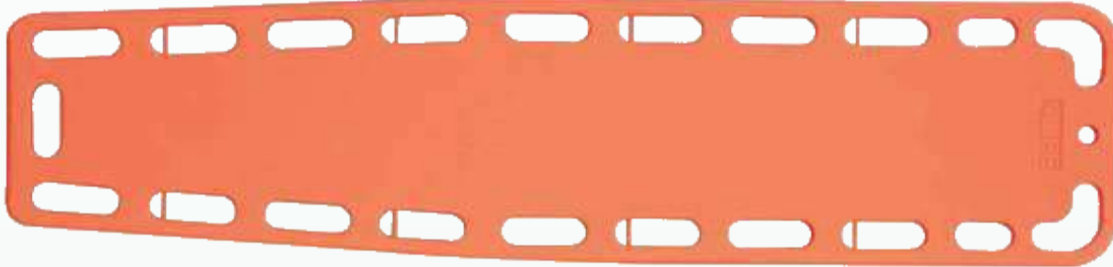

New

IMPORTED MODELS/MANIKIN/SIMULATORS ON TRACHEOTOMY, TUBE FEEDING, GASTROSTOMY, IV INJECTION, NEW BORN RESUSCITATION MODELS ETC.

TRACHEOTOMY

GD/H23 ADULT TRACHEOTOMY CARE SIMULATOR

Features

1. Tracheotomy Care
2. Precise Anatomy, Pharynx, Epiglottis, Trachea, Esophagus, Position of Tracheotomy, Cricoids and left, right bronchial trees
3. Sputum suction
4. Suction via oral cavity
5. Clean and Care of tracheal cannula



IMPORTED DNA / RNA MODELS



XD-335

DNA ACTIVITY MODEL

Size (cm): 12x12x46

Students construct two complete DNA segments with this set. The components consist of four nucleic acid bases: cytosine, adenine, guanine and thymine, that are designed so only the proper bases fit together. Includes 48 bases, four strands, two supporting rods with penestals an illustrated instructions.

XD-336

DNA STRUCTURE SIMULATION KIT

Includes 6 kinds of pieces representing the different parts of DNA structure. An excellent kit for one or two student to build a double helix of DNA, and to learn replication of DNA. The amounts of pieces are enough to build a helix. With case

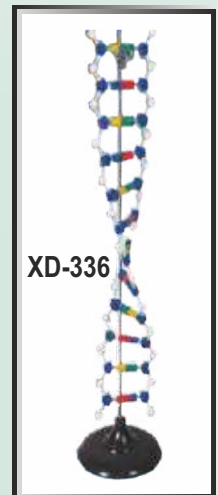

XD-336

IMPORTED STOMATOLOGY / DENTAL TRAINING MODELS



GD/B10012
TRANSPARENT MILK TEETH DEVELOPMENT MODEL
 The model includes maxillary dentition and mandibular dentition and displays the structure of milk maxillary teeth, milk mandibular teeth; total of 14 indication signs. 6X6X6cms

GD/B10014
PERIODONTAL DISEASE MODEL

The model includes 5 parts and displays the structure of normal mandibular molar and periodontal disease development process: a total of 15 indications signs. 4x16x3 cms.

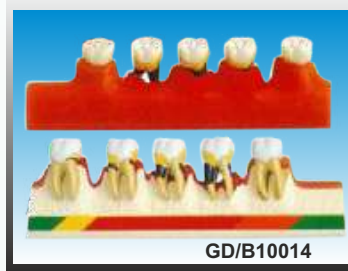

TH-002
DENTAL MODEL SMALL
 • Model with Plastic Hinge



XC-305
EXPANSION MODEL OF HUMAN TEETH

This model shows the morphological differences of the incisor, canine and molar teeth. Dissections of the canine and molar teeth demonstrate the structure of enamel, dental pulp cavity. Enlarged 12 times, 3pcs set.

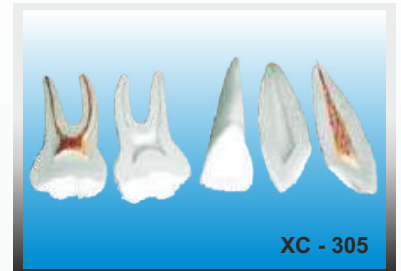

TH-002
DENTAL MODEL SMALL
 • Model with Plastic Hinge



GD/B10035
ORTHODONTIC MODEL
 Shows the abnormal structure of crowded teeth, anti-jaw, protrusion, jaw opening, etc



GD/B10036
FIXED ORTHODONTIC MODEL (NORMAL) Shows the effect after correction in transparent ceramic brackets



XC-403/TH-001
TOOTH HYGIENE SET- CONSISTS OF TEETH, TONGUE AND PALATE WITH BRUSH

This model is to serve for demonstration in mouth protection and relative clinical teaching. Consists of gum, teeth, tongue and palate, It demonstrates teeth form and oral cavity cleaning and protection.



GD/B10037
FIXED ORTHODONTIC MODEL (NORMAL)
 Shows the effect after correction

ITEM NO: GD/B10004
TEETH MODEL

- GD/B10004/1 Lower Incisor 17.5cmx4.5cmx4.5cm
- GD/B10004/2 Lower Canine 22cmx6.5cmx6cm
- GD/B10004/3 Lower Molar with one root 18cmx5.5cmx7cm
- GD/B10004/4 Lower Incisor with Two roots 16cmx8cmx8.5cm
- GD/B10004/5 Lower First Upper Molar with Three roots 16cmx8cmx11cm





GD/B10001
SET OF TEETH OF AN ADULT
 The Model Consists of 32 Teeth made of advanced PVC. Size 10x8x7cms



GD/B10016
PATHOLOGIC TOOTH WITH JAW
 Consists of 2 parts, the upper jaw and the lower jaw. Shows the pathologic structure of decayed tooth, pulpitis, apical putrescence, paradentitis and apical abscess. 20 positions are displayed. Size 18x16x6cms

GD/B10002
LOWER JAW OF 12-YEARS-OLD

The Model Shows the Shape and Conformation of the sets of permanent teeth of child (11-14 years old), as well as the structure of the decayed teeth. 21 positions are displayed. size 17x29x6cms



GD/B10008
DISSECTED MODEL OF DENTAL DISEASE

Displays dental caries destruction, alloy material filling repair, Suppurative pulpitis, pulp necrosis, root abscess, periapical abscess, periodontitis, alveolar Suppurative, etc; There are 7 parts of indication signs. 6x11x4cms.

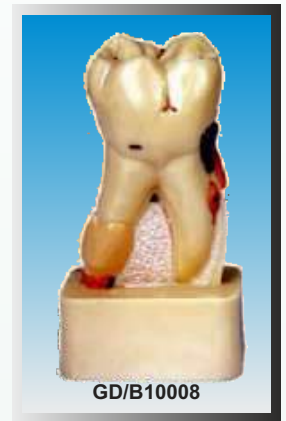

GD/B10003
LOWER JAW OF 18-YEARS-OLD
 The model shows the left half of the lower jaw. The Canine and first molar can be taken out and are detachable. Size 17x29x6 cms

GD/B10005/2
DENTAL CARIES MODEL

The model shows dental caries in initial and advanced stages. 16 positions are displayed. size 39x39x26 cms



GD/B10010
TRANSPARENT ADULT TEETH MODEL

The model includes maxillary dentition and mandibular dentition, and displays the appearance and structure of maxillary teeth and mandibular teeth; a total of 16 parts of indication signs. 6x8x6 cms.



GD/B10006
DEVELOPMENT OF A SET OF TEETH

The model shows the development from temporary teeth to the germination of the permanent teeth, demonstrating the teeth at the ages of less than 6 months, 2 years, 5 to 7 years,

17 to 26 years. Each model shows the upper and lower jaws of right side. They demonstrate the procedures of the germination of temporary teeth, replacement of the teeth, the germination of the permanent teeth, as well as the development of the upper and lower jaws and maxillary sinus. 18 positions are displayed. Life Size

GD/B10011
TRANSPARENT DENTAL PATHOLOGY MODEL

The model includes maxillary dentition and mandibular dentition and displays the structure of adult maxillary teeth, adult mandibular teeth, dental caries, pulpitis, gingival fistula and silver amalgam filling repair, etc; a total of 16 indication signs. 6x8x7 cms

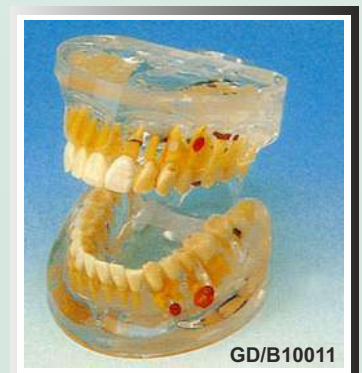

COMMUNITY HEALTH NURSING MODELS

- Made of high grade materials having long durability
- Mounted on sturdy wooden frame for easy display
- Supplied with well illustrated informative literature
- Well labeled parts
- Beautifully painted in bright colors
- Model is a great teaching tool for nursing students

COMMUNITY HYGIENE

- XZ 7101** - Sanitary Well.....Price
- XZ 7102** - Insanitary Well.....Price
- XZ 7103** - Deep and Shallow Well.....Price
- XZ 7104** - Deep Tube WellPrice

- XZ 7105** - Step Well.....Price
- XZ 7106** - Berkefeld Filter.....Price
- XZ 7107** - Slow Sand Filter.....Price
- XZ 7108** - Rapid Sand FilterPrice

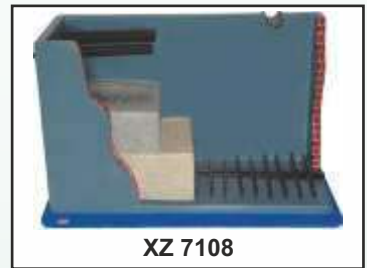
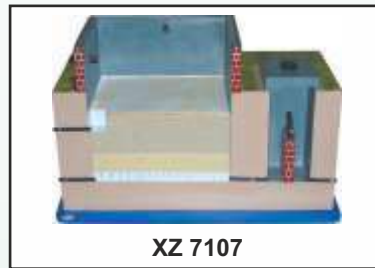
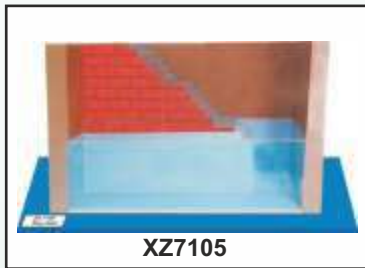
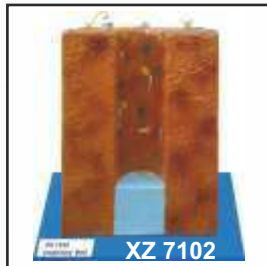
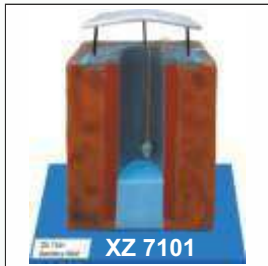

ENVIRONMENTAL SANITATION

- XZ 7201** - House Drainage SystemPrice
- XZ 7202** - Chamber Type Incinerator.....Price
- XZ 7203** - Activated Sludge ProcessPrice
- XZ 7204** - Bore Hole LatrinePrice
- XZ 7205** - Dug Well Latrine (Pit Latrine)Price

- XZ 7206** - Trench LatrinePrice
- XZ 7207** - Septic Tank Latrine.....Price
- XZ 7208** - Biogas PlantPrice
- XZ 7209** - Smokeless ChulhaPrice

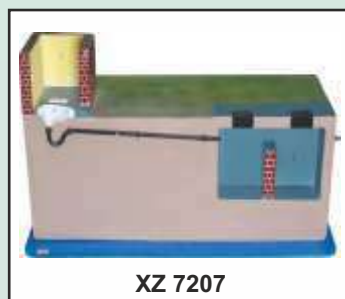
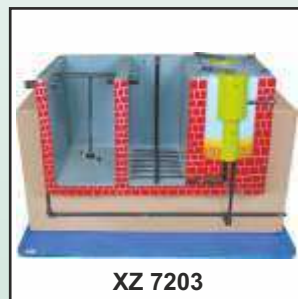

XC-134 New
CUTAWAY OSTEOPOROSIS

Consist of 3 medially divided lumbar vertebrae with intervertebral discs. For comparison, the upper section shows healthy bone structure. The middle section shows osteoporosis bone structure and the lower section shows advanced osteoporotic bone structure with flattened plates, deformation and decreased mass.



XC-134



XC-135

XC-135 New
SKULL WITH CERVICAL SPINE

Life size model of human skull on cervical spine in four parts. Skull is dissectible into 3 parts with moveable jaw, cut calvarium. Cervical spine is shown with seven cervical vertebrae, cervical nerves, vertebral arteries, basilar artery and rear cerebral arteries.

XC-120 New
THORACIC SPINAL COLUMN

This model consists of the 12 thoracic vertebrae with intervertebral discs, thoracic nerves and spinal cord on stand.

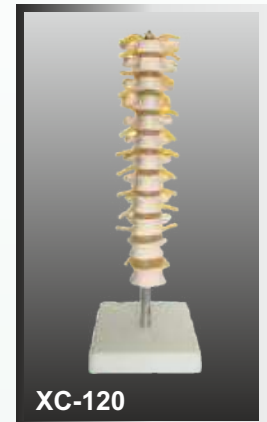

XC-120

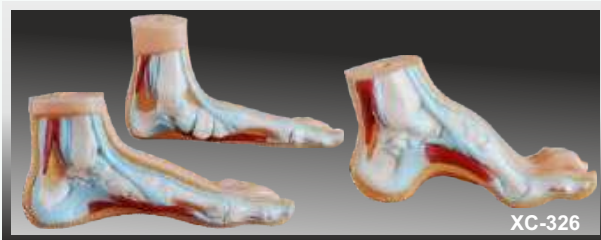

XC-326

XC-326
NORMAL, FLAT & ARCHED FOOT

This model shows the anatomical structure and the distal end of tibia of Normal, Flat & Arched Foot. Set of 3 model.

XC-325
PALM ANATOMY

These life size models show the superficial and internal structures of the palm. Set of 4 model.



XC-325

XC-105C
DIDACTIC VERTEBRAL COLUMN WITH PELVIS

This model is upgraded from XC-105, and features different sections of the spinal column in different color: cervical vertebrae, thoracic vertebrae, lumbar vertebrae, sacrum and the coccyx.

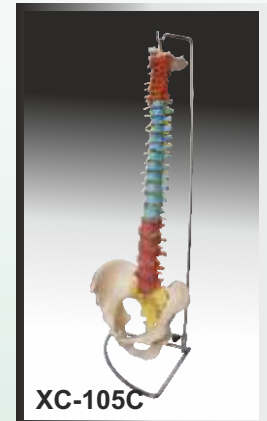

XC-105C

DISPLAY & STORAGE STAND FOR MAPS & CHARTS (INDIAN MADE)

- BN01** MAP STORAGE STAND All iron pipe side hook type for 36 maps each
- BN02** --do-- but for 24 maps each
- BN03** MAP DISPLAY STAND all iron single pipe height adjustable each

SPECIAL DISPLAY SYSTEMS AND STANDS (INDIAN MADE)

- BN04** EXHIBITION DISPLAY SYSTEM - Three panels of 4'x3' each one side pin board and the other side green board for chalk writing or white board for marker writing mounted on 4 pedestal stainless steel stands with heavy base
- BN05** MOBILE BOARD - It can be used on both the sides with White, Green, Black or display boards 4'x3' mounted on stand made of rectangular pipes with wheels/base
- BN06** NEWS PAPER AND MAGAZINE STAND -Sleek stand made of stainless steel



COMMUNITY HEALTH BAGS/MIDWIFERY KIT FOR HOME DELIVERY (INDIAN MADE)

CB-01 COMMUNITY HEALTH BAG AS PER N.C. SPECIFICATIONS

Contains the following items in Bag (Total 38 items)

- | | | |
|-----------------------------|--|---|
| 1. Mucus Sucker | 14. Cotton | 27. Bandage |
| 2. Face Mask | 15. Big Scissor | 28. Towel |
| 3. Sprit Lamp | 16. Small Scissor | 29. Writing pad |
| 4. Surgical Sprit | 17. Cord Clamp | 30. Pen |
| 5. Gloves | 18. Steripad | 31. Leukoplast |
| 6. Test Tube Holder | 19. Feotoscope | 32. Non Toothed forcep |
| 7. Test Tube | 20. Stethoscope | 33. Rectical Thermometer |
| 8. Dettol | 21. Apron | 34. Straight Artery Forcep |
| 9. Kidney Trays | 22. B.P. Handle | 35. Curve can |
| 10. Ounces Glass | 23. Surgical Blades | 36. Tubing for curve can |
| 11. Syringe | 24. Cl. Thermometer | 37. Empty Plastic bottle for
cotton swap |
| 12. Enema Can | 25. Empty Plastic bottle
for solution | 38. High quality Bag with
pockets & carrying strap |
| 13. Tubing for
Enema can | 26. Toothed Forecep | |



CB-02 COMMUNITY HEALTH BAG

Contains the following items in Bag (Total 20 items)

- | | |
|-----------------------------------|-----------------------------------|
| 1. Spirit Lamp | 11. Forcep Non Toothed 5" |
| 2. Test Tube Holder | 12. Artery Forcep (straight) 6.5" |
| 3. Test Tube 5" | 13. Clinical Thermometer |
| 4. Kidney Tray 6" stainless steel | 14. Spring Balance |
| 5. Syringe 5ml | 15. Towel |
| 6. Stethoscope | 16. Measuring Tape |
| 7. Feotoscope | 17. Soap Dish |
| 8. Suture Cutting Scissor | 18. Nail Brush |
| 9. Dressing Scissor 6" | 19. Dropper |
| 10. Forcep Toothed 6" | 20. Small Bowl |



CB-03 MIDWIFERY KIT FOR HOME DELIVERY

Contains the following items in Bag (Total 29 items)

- | | |
|--|--------------------------------------|
| 1. Face Mask | 15. Artery Forcep Straight 6" |
| 2. Surgical Sprit | 16. Artery Forcep Curve 6.5" |
| 3. Gloves | 17. Thumb Forcep – Plain 5" |
| 4. Rubber Mucus Sucker | 18. Thumb Forcep – Toothed 6" |
| 5. Kidney Trays Medium
6" Stainless steel | 19. Umbilical Cord Cutting Scissor |
| 6. Kidney Trays Small | 20. Umbilical Cord Tie |
| 7. Bowls Medium | 21. Enema Can |
| 8. Bowls Small | 22. Tubing / Douch Set for Enema can |
| 9. Syringe 10ml | 23. Cotton |
| 10. Syringe 5ml | 24. Mackintosh |
| 11. Syringe 2ml | 25. Rubber Catheter |
| 12. Hypodermic Needle Pkt. | 26. Spring Balance |
| 13. Apron | 27. Soap Dish |
| 14. Fetoscope | 28. Towel |
| | 29. Measuring Tape |



POLYART PLASTIC HUMAN ANATOMY CHARTS

SIZE 100 x 75 CMS FITTED WITH PLASTIC ROLLERS

- HAB - 01** Skeletal System
- HAB - 02** Muscular System
- HAB - 03** Circulatory System
- HAB - 04** Nervous System
- HAB - 05** Digestive System
- HAB - 06** Teeth and Skin
- HAB - 07** Human Eye , Ear and Head
- HAB - 08** Lymphatic System
- HAB - 09** Respiratory System
- HAB - 10** Endocrine System
- HAB - 11** Nutrition
- HAB - 12** Immune System
- HAB - 13** Human Nose
- HAB - 14** Human Heart
- HAB - 15** Excretory System
- HAB - 16** The Eye
- HAB - 17** The Ear
- HAB - 18** The Kidney
- HAB - 19** Human Lungs
- HAB - 20** Human Liver
- HAB - 21** Human Brain
- HAB - 22** Skin & Sensation
- HAB - 23** Nervous System & Sensory Organs
- HAB - 24** Metabolism
- HAB - 25** Skull & Joints
- HAB - 26** Human Eye & Ear
- HAB - 27** Spinal Chord
- HAB - 28** Abdominal Cavity
- HAB - 29** Human Eye - Psychological Diseases of Eye
- HAB - 30** Understanding Viral Infection
- HAB - 31** Human Tongue
- HAB - 32** Human Endocrine Glands
- HAB - 33** Human Larynx
- HAB - 34** Human Trachae
- HAB - 35** Human Alveolus
- HAB - 36** Human Reflection Arch
- HAB - 37** Human Eye Muscles
- HAB - 38** Human Eye Tear Glands
- HAB - 39** Posterior Abdominal
- HAB - 40** Human Urinary Bladder
- HAB - 41** Human Blood Group
- HAB - 42** Cardiovascular Diseases
- HAB - 43** Classification of Organism: Five Kingdoms
- HBA - 44** Human Gaseous Exchange System
- HAB - 45** Human Blood : Composition and Functions
- HAB - 46** Liver Cirrhosis
- HAB - 47** Locomotory System
- HAB - 48** Lung Cancer : Causes, Symptoms and Preventions

Anatomically Perfect

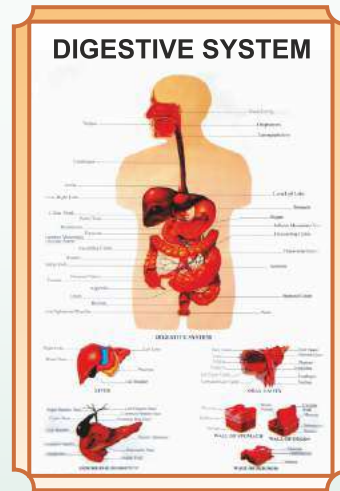
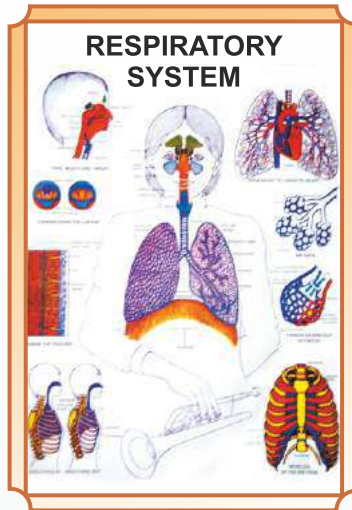

✘
Excellent
easy viewing by
large or small
groups

✘
Happy, healthy
figures shown in
familiar situations

✘
User-friendly
illustrations and
colours

✘
Bright consistent
"teaching" colours
help students
identify systems

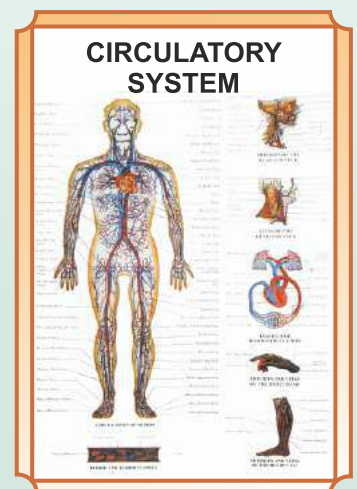
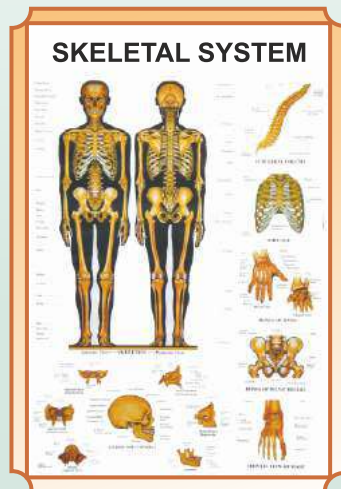

Each Chart

Set of 48 Charts

POLYART PLASTIC HUMAN REPRODUCTION CHARTS

Size 75 x 100 cms. Fitted with Plastic Rollers

POLYART PLASTIC HUMAN REPRODUCTION CHARTS

- HAR 01** Human Reproductive Organs Male
- HAR 02** Human Reproductive Organs Female
- HAR 03** Human Embryological Development
- HAR 04** Human Life Cycle (Birth)
- HAR 05** The Menstrual Cycle
- HAR 06** Placenta
- HAR 07** Human Uterus & Fallopain Tube
- HAR 08** Human Penis & Scrotum

Each Chart

Set of 8 Charts

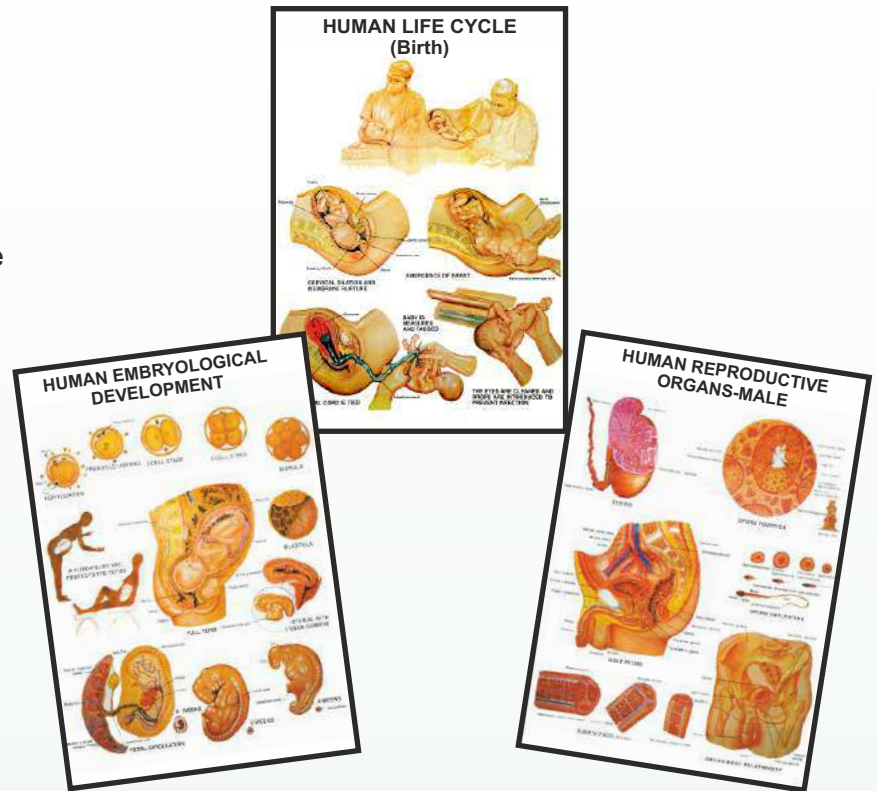

POLYART PLASTIC AIDS CHARTS (SET OF 6)

Size 75 x 100 cms. Fitted with Plastic Rollers

POLYART PLASTIC CHART (SETS OF 6)

- HAD 01** Transmission of Virus that Causes AIDS.
- HAD 02** Sexually Transmitted Diseases (S.T.D.)
- HAD 03** AIDS Symptoms and Preventions
- HAD 04** Non-contagious Nature of AIDS.
- HAD 05** Life Cycle of AIDS.
- HAD 06** Immune System.

Each Chart

Set of 6 Charts

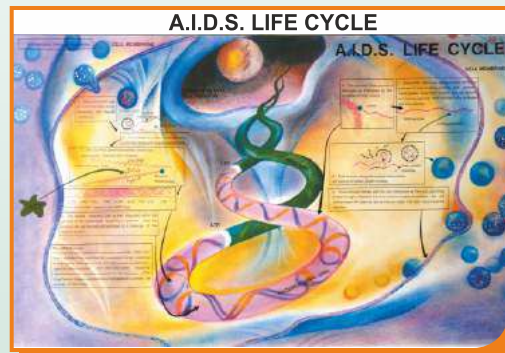



HUMAN ANATOMY
(Set of 11 Models)

HBD 01 50x70 cms complete
 with hard backing aluminium
 angle frame and hanging hooks
 Each Pc. **₹ 1390.00**

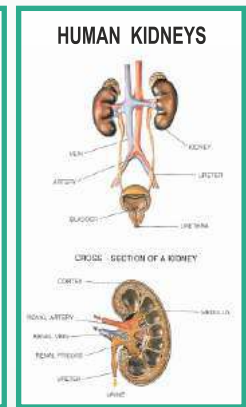
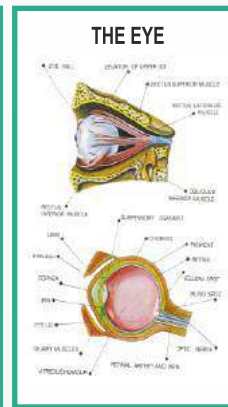
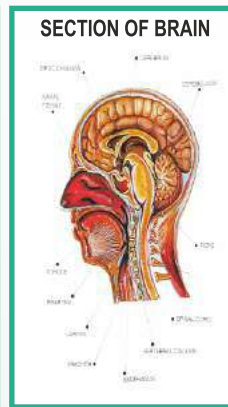
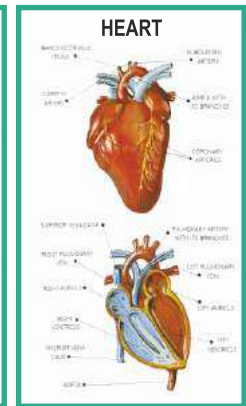
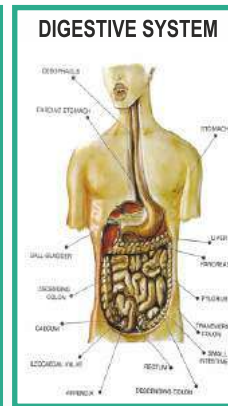
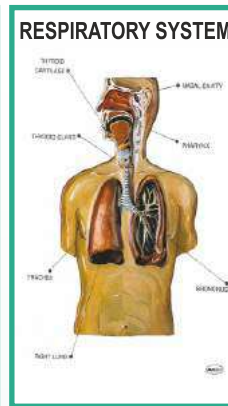

(Set of 11) Includes the following Topics :-

- HD 33** SKELETON
- HD 34** CIRCULATORY SYSTEM
- HD 35** HEART
- HD 36** NERVOUS SYSTEM
- HD 37** SECTION OF BRAIN
- HD 38** MUSCLES
- HD 39** DIGESTIVE SYSTEM
- HD 40** RESPIRATORY SYSTEM
- HD 41** THE EAR
- HD 42** THE EYE
- HD 43** HUMAN KIDNEYS

HUMAN REPRODUCTIVE ORGANS
(Set of 8 Models)

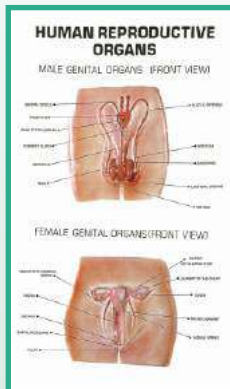

Male Genital Organs
(Front View)

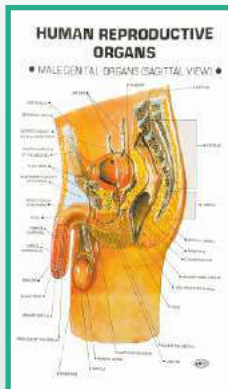

Male Genital Organs
(Sagittal View)

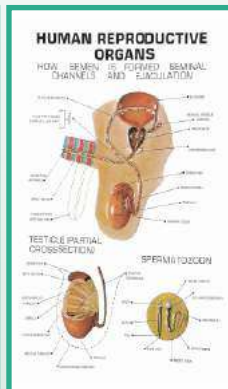

How Semen is formed



First Week of Egg
Development



Fertilization
(Cross Section)
diagram of an Ovary



Eight Month Old Fetus

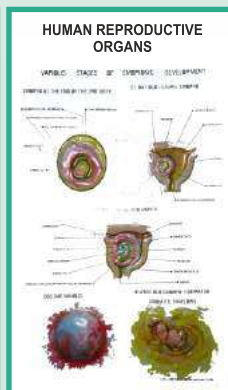

Various Stages of
Embryonic
Development

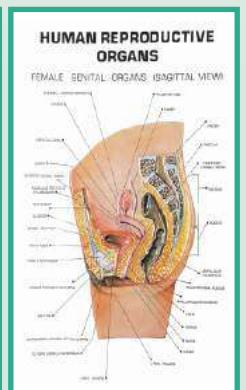

Female Genital
Organs
(Sagittal View)

HDA 02 50x70 cms complete
 with hard backing aluminium
 angle frame and hanging hooks
 Each Pc.

FIRST AID, HEALTH, DISEASES, FAMILY PLANNING MOTHER CRAFT, NEW FOOD CHARTS

PICTORIAL FIRST AID CHARTS

LAMINATED FITTED WITH ROLLERS SIZE 50 X 75 CMS each ₹ 76.00
LAMINATED WITH HARD BACKING & ALUMINIUM FRAME each ₹ 790.00

- | | |
|---|------------------------------|
| 01 Roller Bandages | 09 Hemorrhage |
| 02 Artificial Respiration | 10 Fractures |
| 03 Unconsciousness | 11 Transport of the Injured |
| 04 Emergency Resuscitation | 12 Bandaging |
| 05 Skeleton & Circulatory System | 13 Poisons & Their Antidotes |
| 06 Burns and Scalds | 14 Snakes & Snake Bites |
| 07 Electric Shock and Its Management | 15 Skeleton System |
| 08 Removal of Foreign Bodies from Eye, Ear and Nose | |



COMMON DISEASES AND THEIR PREVENTION CHARTS

LAMINATED FITTED WITH ROLLERS SIZE 50 X 75 CMS each ₹ 76.00
LAMINATED WITH HARD BACKING & ALUMINIUM FRAME each ₹ 790.00

- | | | |
|--------------------------------|--|------------------------|
| 01 Malaria | 09 Cholera | 17 Leprosy |
| 02 Plague | 10 Tuberculosis | 18 Jaundice |
| 03 Typhoid | 11 Influenza | 19 Dysentery |
| 04 Cancer | 12 Viral Diseases | 20 Diabetes |
| 05 AIDS | 13 Heart Attack | 21 Chicken Pox |
| 06 Asthma | 14 Thyroid | 22 Hypertension (B.P.) |
| 07 Hepatitis | 15 Arthritis | 23 Dengu |
| 08 Protein Energy Malnutrition | 16 Immunization Chart for the New Born | |



FAMILY PLANNING CHARTS

- 01 Unplanned Family
- 02 Small Family - Happy Family (Planned Family)
- 03 Temporary methods of family planning
- 04 Space your Child Birth



LAMINATED FITTED WITH ROLLERS SIZE 50 X 75 CMS each
LAMINATED WITH HARD BACKING & ALUMINIUM FRAME each

HEALTH & HYGIENE CHARTS

- 01 Causes of Diseases.
- 02 Tobacco & Other Habit Forming Drugs
- 03 Health Rules
- 04 Effects of Alcohol
- 05 Prevention of Diseases



NEW FOOD CHARTS

These charts contain 110 items with their illustrations, properties and values

CHART No. 01 PART - I

Milk Products - Fruits - Food Grains.

CHART No. 02 PART - II

Vegetables - Pulses - Meat

CHART No. 03 FOOD AND NUTRITION



LAMINATED FITTED WITH ROLLERS SIZE 75 X 100 CMS each
LAMINATED WITH HARD BECKING & ALUMINIUM FRAME each

MOTHER CRAFT AND CHILD WELFARE

LAMINATED FITTED WITH ROLLERS SIZE 50 X 75 CMS each
LAMINATED WITH HARD BACKING & ALUMINIUM FRAME each

- | | |
|--|------------------------------------|
| 01 Welfare of Mother (Diet in Pregnancy) | 05 Baby's Development |
| 02 Preparation for Delivery | 06 Baby's Weight |
| 03 Ready for Confinement | 07 Baby's Diet |
| 04 Correct & Regular Feeding | 08 Care of Mother during Pregnancy |

- Chart size 50x75cms Laminated fitted with Rollers
- Laminated with Hard Backing & Alluminium Frame

Each
Each



- YG01** Surya Namaskar
- YG02** Padmasana, Siddhasana, Yogmudra, Ardha Matsyendrasana, Paschimottanasana, Gomukhasana
- YG03** Vajrasana, Supt Vajrasana, Ushtrasana, Vrushasana, Mandukasana, Shashankasana
- YG04** Pavanmuktasana, Matsyasana, Sarvangasana, Halasana
- YG05** Shalbhhasana, Bhujangasana, Dhanurasana
- YG06** Sheershasana, Mayurasana, Shavasana, Konasana
- YG07** Trikonasana, Tadasana, Urdhva Hastasana, Padhastasana, Chakrasana
- YG08** Purification of the body - Neti, Nauli, Dhauti, Tratak
- YG09** Pranayam I - Anulom-Vilom, Kapal Bhati, Brahmari, Nadi Shuddhi, Agnisara
- YG10** Pranayam II - The Three Bandhas, Ujjayi, Surya Bheda, Bhastrika, Sithali.

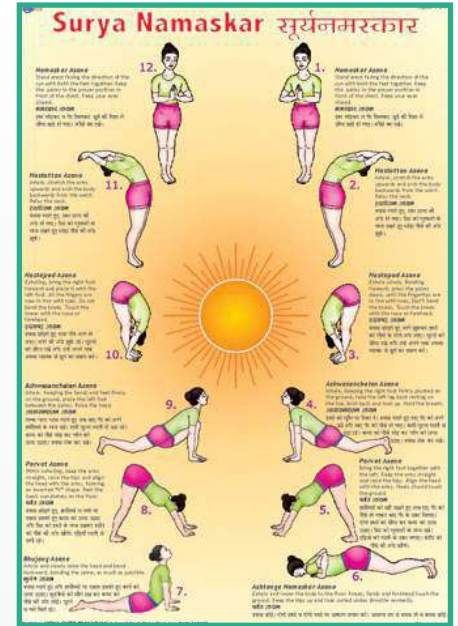

PORTRAITS OF MILESTONES IN MEDICAL SCIENCES

- Size 31x43 Cms. Framed Each

- MS01** Hippocrates
- MS02** William Harvey
- MS03** Hermann Helmholtz
- MS04** Charles Herbert Best
- MS05** Fredrick Grant Banting
- MS06** Louis Pasture
- MS07** Karl Landstenier
- MS08** Robert Koch
- MS09** Stephen Hales
- MS10** Rene T.h.Laennec
- MS11** Aristotle
- MS12** Susruta
- MS13** Ronald Ross
- MS14** Edward Jenner
- MS15** Sir Joseph Lister
- MS16** Morgagni
- MS17** Sir J. Young Simpson
- MS18** Galen
- MS19** Charles Sherrington
- MS20** Samuel Hahnemann
- MS21** Leonardo-Da-Vinci
- MS22** Thomos Henry Huxley

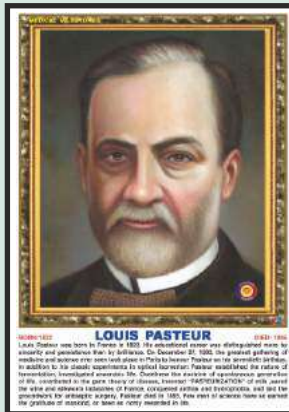
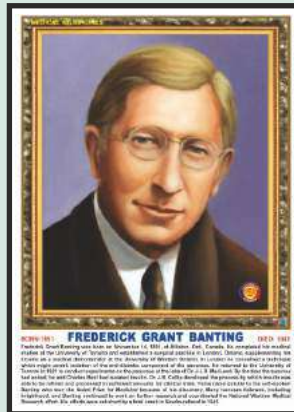
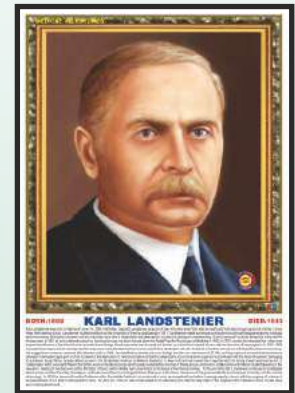
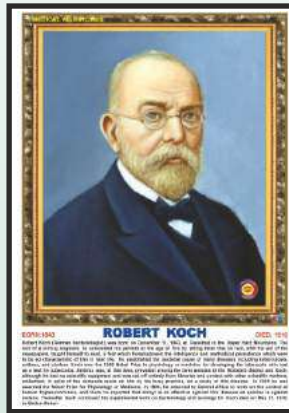
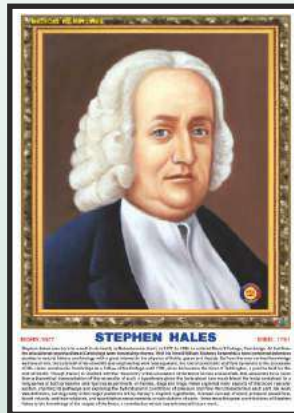

- MS23** Anton Van Leeuwenhoek
- MS24** Alferd Russel Wallace
- MS25** Sir Charles Bell
- MS26** Gregor Mendel
- MS27** Hugo De-Vries
- MS28** Maharishi Charak
- MS29** Dhanvantari
- MS30** Ashwini Kumars
- MS31** Oath of Pharmacist
- MS32** Mother Teresa
- MS33** Florence Nightingale
- MS34** Oath of Nursing (Nightingale Pledge)

THE PORTRAITS ARE ON HARD NUWOOD WITH PLASTIC FRAMING

VISUAL TEACHING AIDS

OVERHEAD PROJECTOR (Single Bulb)

Specification

- ✧ Low Voltage
- ✧ Latest Design
- ✧ Single Halogen Lamp 24V-250W
- ✧ Rack & Pinion Focusing System
- ✧ Light Weight.
- ✧ Metal Body
- ✧ Motorised cooling System
- ✧ Intensity Control



OVERHEAD PROJECTOR (Double Bulb)

Specification

- ✧ Twin Lamp 24V-250W (Specification same as above but equipped with dual bulb system)

SLIDE PROJECTOR MANUAL MODEL

Specification

- ✧ Versatile design
- ✧ Noiseless cooling system
- ✧ Rigid construction
- ✧ Manual Focusing
- ✧ Halogen Lamp 24V-150W
- ✧ Slide carrier for 2 slides
- ✧ Height adjustable
- ✧ Slide carrier for 2 slides



ADDITIONAL ACCESSORIES

- a) Projection Screen 70"x52" (175x130 cms) with folding tripod stand. Superior quality
- b) Map Screen made of thick white rexine with wooden roller 175x135cms.
- c) Overhead Projector marker set of 7 pens including Eraser Pen Per Set
- d) Bulb for OHP 24v-250W
- e) Bulb for Slide Projector 24v-150W
- f) Blank Overhead Projector Transparencies - 210x297 mm Packet of 100 Sheets Per Pkt

LASER POINTER

- a) Laser Pointer Pen Type with AAA size batteries.
- b) Laser Pointer Pen with button cells

OVERHEAD PROJECTOR TRANSPARENCIES

per transparency

OHP01 Human Physiology (Set of 50)

OHP02 Sense organs (Set of 20)

OHP03 First Aid (Set of 50)



LCD PROJECTOR (IMPORTED)

PRICE ON REQUEST

This is the Best value projector ideal for class room, workshop. This can be directly attached to the computer and makes your presentation more exciting with high brightness, high contrast and colors. This can be fit to the ceiling, front or rear positions. The cost of accessories for ceiling fitting is extra. This has computer compatibility with Mac PC or Windows PC. The maximum Resolution is 1920x1200 and Contrast ratio is 20000:1. The Digital zoom is 2x and colour support is 30-bit. The minimum focal length is 21.79mm and the maximum focal length 23.99mm. The minimum Projector distance is 1 Mts. and the Maximum Projector distance is 11.90 Mts



NURSING SLIDE SET (ON FUJI FILM)

BNS01	Basic Nursing Skills	Set of 40
BNS02	Burns & Nursing	Set of 40
BNS03	Fundamentals of Nursing	Set of 60
BNS04	History of Nursing	Set of 20
BNS05	Infant Nursing	Set of 40
BNS06	Medical Surgical Nursing	Set of 20
BNS07	Maternity Nursing	Set of 20
BNS08	Nursing Responsibilities & Implications	Set of 100
BNS09	Oncologic Nursing	Set of 40
BNS10	Pediatric Nursing	Set of 40
BNS11	Emergency Delivery	Set of 20

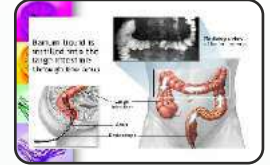

HEALTH SECTION SLIDE SET (ON FUJI FILM)

PREVENT THE DISEASES

each set contain 20 slides

PDS 01	Cholera
PDS 02	Malaria
PDS 03	Aids
PDS 04	Plague
PDS 05	Tuberculosis
PDS 06	Leprosy
PDS 07	Influenza
PDS 08	Jaundice
PDS 09	Cancer
PDS 10	Typhoid
PDS 11	Viral Diseases
PDS 12	Chicken Pox
PDS 13	Dysentery
PDS 14	Hepatitis
PDS 15	Heart Attack
PDS 16	Diabetes
PDS 17	Asthma
PDS 18	Arthritis

HEALTH CARE each set contain 20 slides

HCS01	Health Rules
HCS02	Causes of Diseases
HCS03	Prevention of Diseases
HCS04	Effects of Alcohol
HCS05	Tobacco & Habit Forming Drugs
HCS06	Clean Body
HCS07	Clean Water
HCS08	Constituents of Food
HCS09	Malnutrition
HCS10	Immunization

OTHERS

HCS01	Human Physiology set of 50
HCS03	Yogasan set of 20
HCS04	Vitamin set of 10
HCS06	Human Body set of 10
HCS07	First Aid set of 50
HCS09	Mothercraft set of 30
HCS11	Child Welfare set of 20
HCS12	Family planning set of 100



3D RAISED RELIEF PLASTIC SCIENTIFIC MODELS MADE IN ITALY



HUMAN REPRODUCTION MALE & FEMALE MODELS (SET OF 8)

RC01Y Size: 25x35cms (Supplied in sets only)

Each Set of 8

- RC001** Male & Female Reproductive Organs
- RC002** (M) Genital Organs
- RC003** (F) Genital Organs
- RC004** How Semen is Formed
- RC005** Fertilization
- RC006** First Week of Egg Development
- RC007** Eight Month old Foetus
- RC008** Various Stages of Embryonic Development

HUMAN ANATOMY/PHYSIOLOGY MODEL (SET OF 8)

RC01X Size: 25x35cms (Supplied in sets only)

Each Set of 8

- RK056** Skeleton
- RK057** Muscles
- RK058** Brain & Nervous System
- RK059** Organs of Taste
- RK060** Circulation of Blood
- RK061** Digestive System
- RK062** Respiratory System
- RK063** Eye, Ear & Skin

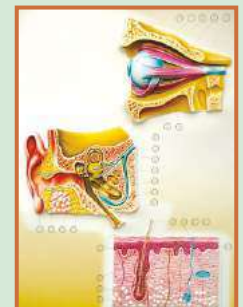

CHARTS	Page No.	MODELS (ALL IMPORTED)	Page No.
Charts Of Human Anatomy	1	COMMUNITY BAGS	56
Charts Of Anatomy Embossed	7	COMMUNITY HYGIENE MODEL	54
Charts Of Bio Chemistry	3	CONDOM TRAINING MODEL	24
Charts Of Bio Medical Technology	4	CONTRACEPTION FEMALE PRACTICE MODEL	24
Charts of Common Diseases	61	CONTRACEPTION GUIDANCE MODEL	48
Charts Of Diabetes Imported	9	COURSE OF DELIVERY MODEL	20
Charts Of Diseases	4	CPR AND INTUBATION TRAINING MANIKIN (ADULT) New	46
Charts Of Endocrine System (Imported)	9	CPR MANIKIN WHOLE BODY/HALF BODY (M /F)	33
Charts Of Eye, E.N.T. (Imported)	10	CPR PRACTI-BABY MANIKIN CHILD (MALE)	31
Charts of Family Planning	60	CPR TRAINING MANIKIN ADULT (HALF BODY)	30
Charts of First Aid	60	CPR TRAINING MANIKIN ADULT/CHILD /INFANT	29
Charts Of Gynecology & Reprod. (Imported)	9	CUTAWAY OSTEOPOROSIS MODEL New	55
Charts of Health & Hygiene	60	DECUBITUS ULCER CARE SIMULATOR	40
Charts Of Health Awareness	2	DELIVERY MECHANISM DEMONSTRATION SIMULATOR	42
Charts Of Heart & Circulatory (Imported)	8	DEVELOPMENT PROCESS FOR FETUS MODEL	20
Charts Of HIV & Aids (Imported)	9	DIDACTIC VERTEBRAL COLUMN WITH PELVIS	55
Charts of Human Anatomy	57	DIGESTIVE SYSTEM MODEL	15
Charts of Human Reproduction	58	DNA ACTIVITY/ DNA STRUCTURE SIMULATION KIT	51
Charts Of Immune System (Imported)	10	EAR MODEL	18
Charts Of Micro Biology	5	ELBOW JOINT LIFE SIZE	12
Charts of Mother Craft	60	ELDERLY FULLY-FUNCTIONAL NURSING MANIKIN (M/F)	36
Charts Of Nervous System (Imported)	9	EMBRYO MODEL	17
Charts of New Food	60	ENVIRONMENTAL SANITATION MODEL	54
Charts Of Nursing Lab	6	EXTERNAL FIXATION TRAINING SIMULATION MODEL New	41
Charts Of Pharmacology	2	EYE MODEL GIANT SIZE	16
Charts Of Respiratory System (Imported)	10	EYE WITH ORBIT	16
Charts Of Skeleton System (Imported)	8	FERTILIZATION AND EARLY EMBRYOLOGY MODEL	42
Charts Of Systems Human Body (Imported)	10	FETUS WITH VISCUS AND PLACENTA	20
Charts Of Teeth And Jaw (Imported)	8	FOOT JOINT LIFE SIZE	12
Charts Of Weight And Diet (Imported)	8	FOR CERVICAL DILATION	47
Charts of Yogasan	61	GENITAL ORGANS MALE /FEMALE MODEL	23
Charts of AIDS	58	GYNECOLOGICAL EXAMINATION MODEL	38
3D Charts of Human Anatomy (set of 11)	59	GYNECOLOGICAL TRAINING SIMULATOR ADVANCED	39
3D Charts of Human Reproductive Organs (Set of 8)	59	HAND JOINT LIFE SIZE	12
3D Relief Models of Human Anatomy (Imported) New	63	HEAD & NECK WITH BLOOD VESSELS New	34
3D Relief Models of Human Reproduction (Imported) New	63	HEAD MODEL	16
		HIP JOINT LIFE SIZE	12
		INJECTABLE TRAINING ARM MODEL	26
MODELS (ALL IMPORTED)		INJECTION ARM MODEL INTERDERMAL New	34
ABDOMINAL PALPATION & DELIVERY MECHANISM SIMULATOR	47	INJECTION INSULIN PAD MODEL New	34
ADV NEONATAL PERIPHERAL & CENTRAL VEIN INTUBATION	22	INTRAMUSCULAR INJECTION TRAINING MODEL ADULT	25
AED SIMULATOR AND CPR MANIKIN SET	44	IUD TRAINING MODEL	37
AED TRAINER, AED TRAINER WITH CPR MANIKIN	32	IUD TRAINING SIMULATOR	44
AIRWAY INTUBATION SIMULATOR	25	IV INJECTION PAD	48
AIRWAY MANAGEMENT MODEL	25	IV TRAINING ARM MODEL FULL-FUNCTIONAL	24
APPENDIX AND CAECUM	23	IV TRAINING HAND ELECTRONIC	48
ARM SURGICAL SUTURING MODEL	26	JUMBO HEART MODEL/HEART LIFE SIZE	15
AUTOMATIC BIRTHING SIMULATOR REAL DELIVERY	35	KIDNEY WITH ADRENAL GLAND/1 PART/2 PART	19
BABY OBSTRUCTION /INFANT CPR SIMULATOR	22	KNEE JOINT LIFE SIZE	12
BABY OBSTRUCTION /INFANT CPR SIMULATOR	44	LABOUR DELIVERY MODEL	41
BIRTH DEMONSTRATION MODEL	13	LARYNX HEART AND LUNG MODEL	15
BLOOD PRESSURE ARM/CHILD IV ARM MODEL	48	LARYNX HUMAN MAGNIFIED MODEL	19
BRAIN WITH ARTERIES	15	LCD Projector (Imported)	63
BRAIN WITH ARTERIES ON HEAD	16	LEG SURGICAL SUTURE MODEL	26
BREAST EXAMINATION MODEL	40	LIVER MODEL	17
BUTTOCK INJECTION MODEL	26	LIVER, PANCREAS & DUODENUM MODEL	19
BUTTOCK INJECTION SIMULATOR ELECTRONIC	48	LOWER TORSO MANIKIN FEMALE WITH NORMAL & LUMBAR VERTEBRAL	13
BUTTOCK INTRAMUSCULAR INJECTION SIMULATOR	49	LUNG DEMONSTRATION MODEL	19
CATHETERIZATION TRAINING SIMULATOR (M / F)	41	LUNG SEGMENT TRANSPARENT MODEL New	19
CENTAL VENOUS CATHETERIZATION SIMULATOR	22	LUNG, TRACHEA AND BRONCHIAL TREE WITH HEART New	34
CHILD BIRTH SIMULATOR ALONG WITH ATTACHMENTS	47	MALE MUSCLE FIGURE MODEL	25
CHILD NURSING MANIKIN MULTIFUNCTION	43	MALE/FEMALE INTERNAL & EXTERNAL ORGANS	21
CHILD NURSING MODEL FULL-FUNCTIONAL New	36	MANIKIN NURSING BASIC COMBINATION	27
CHILDBIRTH DEMONSTRATION MODEL	38	MANIKIN NURSING MULTI-FUNCTIONAL	27
CHILDBIRTH SKILL TRAINING SIMULATOR	39	MATERNITY EXAMINATION MODEL	40
COMBAT ADULT RESCUE MANIKIN	47		

MODELS (ALL IMPORTED)

MIDWIFERY KIT FOR HOME DELIVERY	56
MIDWIFERY TRAINING SIMULATOR	38
Mobile Board (Indian)	55
MODELS (INDIAN)	Not Available
NASAL CAVITY ANATOMICAL	18
NASAL, ORAL, PHARYNX AND LARYNX CAVITY New	16
NASOGASTRIC FEEDING & TRACHEAL INTUBATION SIMULATOR	40
NEONATA INTUBATION TRAINING MODEL	22
NEONATAL NURSING & CPR MANIKIN ADVANCED	43
NERVOUS/CIRCULA./DIGESTIVE /LYMPHATIC SYSTEM	50
NEURON MODEL	23
NEWBORN BABY 1 MONTH New	7
NEWBORN BABY WITH VISIBLE UMBICAL CORD New	7
NEWBORN BABY WITHOUT VISIBLE UMBICAL CORD New	7
NEWBORN FETUS New	7
NEWBORN INTUBATION BABY MODEL MALE/FEMALE	20
CPR PRACTI-BABY MANIKIN CHILD (MALE) New	31
CPR TRAINING MANIKIN ADULT (HALF BODY)	30
CPR TRAINING MANIKIN ADULT/CHILD /INFANT	29
CUTAWAY OSTEOPOROSIS MODEL	55
DECUBITUS ULCER CARE SIMULATOR	40
DELIVERY MECHANISM DEMONSTRATION SIMULATOR	42
DEVELOPMENT PROCESS FOR FETUS MODEL	20
DIDACTIC VERTEBRAL COLUMN WITH PELVIS New	55
DIGESTIVE SYSTEM MODEL	15
DNA ACTIVITY/ DNA STRUCTURE SIMULATION KIT	51
EAR MODEL	18
ELBOW JOINT LIFE SIZE	12
ELDERLY FULLY-FUNCTIONAL NURSING MANIKIN (M/F)	36
EMBRYO MODEL	17
ENVIRONMENTAL SANITATION MODEL	54
EXTERNAL FIXATION TRAINING SIMULATION MODEL	41
EYE MODEL GIANT SIZE	16
EYE WITH ORBIT	16
FERTILIZATION AND EARLY EMBRYOLOGY MODEL	42
FETUS WITH VISCUS AND PLACENTA	20
FOOT JOINT LIFE SIZE	12
FOR CERVICAL DILATION	47
GENITAL ORGANS MALE /FEMALE MODEL	23
GYNECOLOGICAL EXAMINATION MODEL	38
GYNECOLOGICAL TRAINING SIMULATOR ADVANCED	39
HAND JOINT LIFE SIZE	12
HEAD & NECK WITH BLOOD VESSELS	34
HEAD MODEL	16
HIP JOINT LIFE SIZE	12
INJECTABLE TRAINING ARM MODEL	26
INJECTION ARM MODEL INTERDERMAL	34
INJECTION INSULIN PAD MODEL	34
INTRAMUSCULAR INJECTION TRAINING MODEL ADULT	25
IUD TRAINING MODEL	37
IUD TRAINING SIMULATOR	44
IV INJECTION PAD	48
IV TRAINING ARM MODEL FULL-FUNCTIONAL	24
IV TRAINING HAND ELECTRONIC	48
JUMBO HEART MODEL/HEART LIFE SIZE	15
KIDNEY WITH ADRENAL GLAND/1 PART/2 PART	19
KNEE JOINT LIFE SIZE	12
LABOUR DELIVERY MODEL	41
LARYNX HEART AND LUNG MODEL	15
LARYNX HUMAN MANGIFIED MODEL	19
NEWS PAPER & MAGAZINE STAND (INDIAN)	55
NORMAL, FLAT & ARCHED FOOT New	55
NURSE BASIC PRACTICE TEACHING MODEL	25

MODELS (ALL IMPORTED)

NURSE TRAINING DOLL MALE/FEMALE	28
NURSING & WOUND CARE MANIKIN (M /F)	37
NURSING BABY (UNISEX) ADVANCE	38
OHP Transparencies (Indian)	63
OVARY MODEL	20
Over Head Projector (Indian)	63
PALM ANATOMY New	55
PATIENT CARE NURSING MANIKIN MALE New /FEMALE	28
PELVIS FEMALE	13
PELVIS FEMALE WITH MUSCLE & ORGANS	13
PELVIS HUMAN MALE/FEMALE	21
PELVIS MALE	13
PERINEUM CUTTING & SUTURING TRAINING MODEL New	43
PERITONEAL DIALYSIS SIMULATOR	26
PICC LINE MODEL	49
PLACENTA HUMAN ANATOMISE MODEL	23
PLACENTAL HUMAN MODEL	37
PORTRAITS OF MEDICAL SCIENCES (INDIAN)	62
POSTPARTUM UTERUS	39
PROSTATE INSPECTION MODEL	40
PULMONARY ALVEOLI MODEL	19
PUMPING HEART MODEL (ADV)	17
SHOULDER JOINT LIFE SIZE	12
SKELETON DISARTICULATED (200 BONES)	11
SKELETON DISARTICULATED (UNILATERAL) (100 BONES) New	11
SKELETON HUMAN FEMALE LIFE SIZE	11
SKELETON HUMAN MALE LIFE SIZE	11
SKELETON HUMAN MEDIUM	11
SKELETON HUMAN MINI	14
SKELETON HUMAN WITH MUSCLE & LIGAMENT	11
SKIN BLOCK MODEL/SKIN MODEL	16
SKULL ADULT	14
SKULL DISARTICULATED	14
SKULL FOETAL	14
SKULL INFANT	14
SKULL WITH CERVICAL SPINE New	55
Slide Projector (Indian)	63
Slides Coloured (Indian)	60
SPINAL CORD IN THE SPINAL CANAL MODEL	50
SPINE BOARD (FULL SIZE) New	51
SPLEEN, PANCREAS & DUODENUM MODEL	17
STOMACH MODEL	15
SURGICAL SUTURING AND BANDAGING SIMULATOR	49
SUTURE PRACTICE PAD	48
TEETH MODEL / TOOTH HYGIENE SET	52
TEETH ON AN ADULT /TRANSPARENT DENTAL MODEL	53
THORACIC SPINAL COLUMN New	55
TOOTH HYGIENE SET/DENTAL MODEL	18
TORSO HUMAN LIFE SIZE 85CM/50CM/26CM	17
TRACHEA HUMAN INTUBATION MODEL	25
TRACHEA INTUBATION ELECTRONIC MODEL	45
TRACHEOTOMY CARE SIMULATOR ADULT New	51
TRAUMA CARE MANIKIN ADVANCED	45
URINARY BLADDER MODEL	18
URINARY ELECTRONIC MODEL	28
URINARY SYSTEM MODEL	23
UROGENITAL SYSTEM MALE /FEMALE	21
UTERUS MAGNIFIED MODEL	23
VASOLIGATION TRAINING SIMULATOR	42
VEIN INJECTION ARM FULL-FUNCTIONAL	24
VENIPUNCTURE NEONATE SCALP MODEL	26
VERTEBRAL COLUMN WITH PELVIS	14
VULVA SUTURING TRAINING SIMULATOR	26

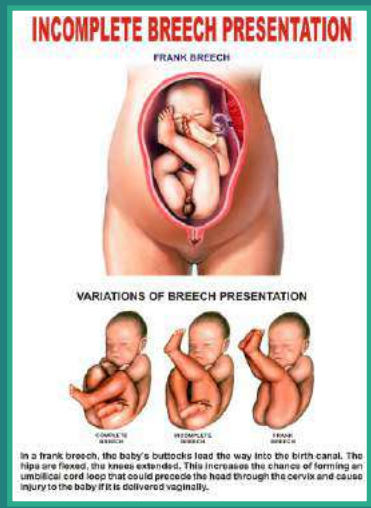
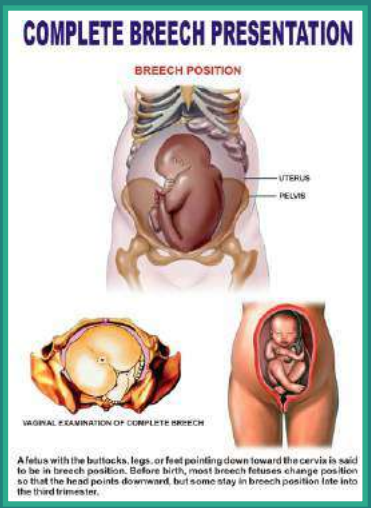
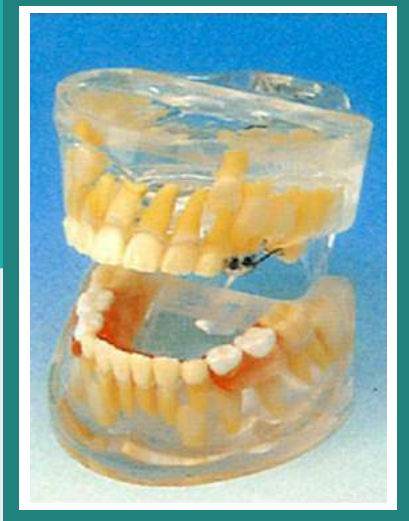
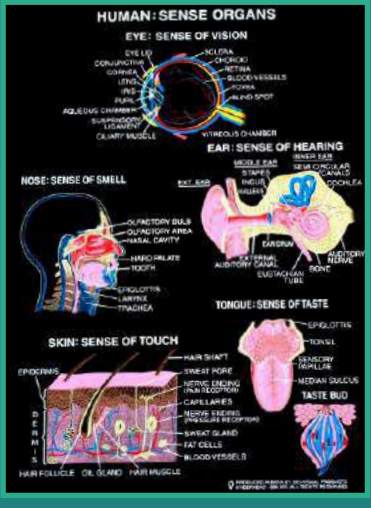

“ IT HAS BEEN OUR PLEASURE TO SERVE YOU OVER THE PAST SO MANY YEARS. WE WANT YOU TO KNOW THAT WE TRULY VALUE YOUR BUSINESS & APPRECIATES FOR YOUR PROMPT ACTION. WE ASSURE YOU OF OUR BEST SALES & SERVICES FROM OUR END. ”

TERMS & CONDITIONS

1. All the Items of the Catalogue are offered from ready stock but are subject to availability at the time of supply.
2. All Prices are Ex-Godwon, packing, booking insurance, freight & postage charges extra.
3. IGST 18% extra (subject to change by G.O.I. from time to time) (Chapter 90230010)
4. Maps & Charts are exempted from IGST (Chapter 4905).
5. Please mention the Code no. of the items for correct compliance.
6. Photos are for illustration only.
7. Write clearly mentioned the destination, mode of dispatch, speed post/courier etc.
8. We need advance payment by draft / cheque / R.T.G.S. Please ask for bank details.
9. Prices & Specification are subject to change without notice.
10. This cancels all our previous quotations, offers, price list etc.
11. All disputes if any are subject to Meerut Jurisdiction only.
12. Please mention your GSTIN No. while placing your order.



JULLUNDUR ENTERPRISES

ADDRESS : 1568-A, G-22,23, Bhagirath Palace, Delhi-110006 (INDIA)

PHONE : 011-23860035, 011-23860283

MOBILE : +91 9871432046, +91-9312281439, +91-9810660343

EMAIL : info@jemediguard.com

WEBSITE : www.jemediguard.com

**WHO APPROVED
CFC FREE
COLD CHAIN EQUIPMENT**



VACCINE CARRIER

MODEL NO.1

Small Vaccine Carrier

- WHO approved
- CFC Free Small vaccine carrier **MODEL NO.1**
- with 2 Icepacks of 0.40 ltrs

Specifications:

- WHO PQS approved
- CFC Free Vaccine Carrier
- Short Range Model with 2 Icepacks of 0.4ltrs
- WHO PQS Code : E004/007
- Vaccine storage capacity as per standard PQS load 0.80ltrs
- Gross vaccine storage capacity 0.80 Liters
- Min. Cold life as per WHO PQS requirement is 15 hrs
- Actual Cold life tested without opening minimum 20 hours 16 minutes at 43 deg C



VACCINE CARRIER

MODEL NO.2

Large Vaccine Carrier

- WHO approved
- CFC Free Large vaccine carrier **MODEL NO.2**
- with 4 Icepacks of 0.40 ltrs

Specifications:

- WHO PQS approved
- CFC Free Vaccine carrier
- Long range model with 4 Icepacks of 0.4ltrs
- WHO PQS Code : E004/008
- Vaccine storage capacity as per standard PQS Load 1.35 Liters
- Gross vaccine storage capacity 1.35 Liters
- Min. Cold life as per WHO PQS requirement is 30 hrs
- Actual Cold life tested without opening at 43 deg. C is 40 hrs 02 minutes



VACCINE CARRIER

MODEL NO.3

Large Vaccine Carrier

- WHO approved
- CFC Free Large vaccine carrier **MODEL NO.3**
- with 4 Icepacks of 0.60 ltrs

Specifications:

- WHO PQS approved
- CFC Free Vaccine carrier
- Long range model with 4 Icepacks of 0.6ltrs
- WHO PQS Code : E004/009
- Vaccine storage capacity as per standard PQS Load 2.46 Liters
- Gross vaccine storage capacity 2.50 Liters
- Min. Cold life as per WHO PQS requirement is 30 hrs
- Actual Cold life tested without opening at 43 deg. C is 50 hrs 12 minutes



COLD BOX

MODEL NO.4

Small Cold Box, Short Range

- WHO approved
- CFC Free Small Cold Box
- short range cold box **MODEL NO.4**
- with 32 Icepacks of 0.40 ltrs

Specifications:

- WHO PQS approved
- CFC Free Cold box Short Range with 32 Icepacks of 0.4ltrs
- WHO PQS Code : E004/016
- Vaccine storage capacity as per standard PQS Load 16.0 Liters
- Gross vaccine storage capacity 20.80 Liters
- Min. Cold life as per WHO PQS requirement is 48 hrs
- Actual Cold life tested without opening at 43 deg. C is 80 hrs 19 minutes



COLD BOX

MODEL NO.5

Small Cold Box, Long Range

- WHO approved
- CFC Free Small Cold Box
- long range cold box **MODEL NO.5**
- with 26 Icepacks of 0.40 ltrs

Specifications:

- WHO PQS approved
- CFC Free Cold box
- Long range model with 26 Icepacks of 0.4ltrs
- WHO PQS Code : E004/023
- Vaccine storage capacity as per standard PQS Load 6.0 Liters
- Gross vaccine storage capacity 11.61 Liters
- Min. Cold life as per WHO PQS requirement is 96 hrs
- Actual Cold life tested without opening at 43 deg.C is 132 hrs 18 minutes



COLD BOX

MODEL NO.6

Large Cold Box, Short Range

- WHO approved
- CFC Free Large Cold Box
- short range cold box **MODEL NO.6**
- with 24 Icepacks of 0.60 ltrs

Specifications:

- WHO PQS approved
- CFC Free Cold box
- Short Range model with 24 Icepacks of 0.6ltrs
- WHO PQS Code : E004/017
- Vaccine storage capacity as per standard PQS
Load 16.0 Liters
- Gross vaccine storage capacity 22.91 Liters
- Min. Cold life as per WHO PQS requirement is 48 hrs
- Actual Cold life tested without opening at 43 deg. C is 93 hrs 33 minutes



COLD BOX

MODEL NO.7

Large Cold Box, Long Range

- WHO approved
- CFC Free Large Cold Box
- Long range cold box **MODEL NO.7**
- with 50 Icepacks of 0.30 ltrs

Specifications:

- WHO PQS approved
- CFC Free Cold box
- Long Range model with 50 Icepacks of 0.3ltrs
- WHO PQS Code : E004/015
- Vaccine storage capacity as per standard PQS Load 18.0 Liters
- Gross vaccine storage capacity 22.21 Liters
- Min. Cold life as per WHO PQS requirement is 96 hrs
- Actual Cold life tested without opening at 43 deg. C is 126 hrs 32 minutes



COLD BOX

MODEL NO.8

Large Cold Box, Long Range

- WHO approved
- CFC Free Large Cold Box
- Long range cold box **MODEL NO.8**
- with 44 Icepacks of 0.40 ltrs

Specifications:

- WHO PQS approved
- CFC Free Cold box
- Long Range model with 44 Icepacks of 0.4ltrs
- WHO PQS Code : E004/014
- Vaccine storage capacity as per standard PQS Load 18.0 Liters
- Gross vaccine storage capacity 21.70 Liters
- Min. Cold life as per WHO PQS requirement is 96 hrs
- Actual Cold life tested without opening at 43 deg. C is 147 hrs 14 minutes



COLD BOX

MODEL NO.9

Large Cold Box, Long Range

- WHO approved
- CFC Free Large Cold Box
- Long range cold box **MODEL NO.9**
- with 31 Icepacks of 0.60 ltrs

Specifications:

- WHO PQS approved
- CFC Free Cold box
- Long Range model with 31 Icepacks of 0.3ltrs
- WHO PQS Code : E004/024
- Vaccine storage capacity as per standard PQS Load 18.0 Liters
- Gross vaccine storage capacity 23.70 Liters
- Min. Cold life as per WHO PQS requirement is 96 hrs
- Actual Cold life tested without opening at 43 deg. C is 145 hrs 51 minutes



ICE PACK

MODEL NO.10



Icepack of 0.3 litre capacity MODEL NO.10

- Material : HDPE (High Density Polyethylene)
- WHO PQS code : E005/004
- Size : 0.3 Litres
- Volume of Ice per pack : 0.305 Litres
- External dimensions (Approx.): 163x91x33 mm
- Weight empty : 76 gms
- Weight Filled : 363 gms

JULLUNDUR ENTERPRISES

ICE PACK



MODEL NO.11

Icepack of 0.4 litre capacity MODEL NO.11

- Material : HDPE (High Density Polyethylene)
- WHO PQS code : E005/005
- Size : 0.4 Litres
- Volume of Ice per pack : 0.355 Litres
- External dimensions (Approx.): 163x95x34 mm
- Weight empty : 78 gms
- Weight Filled : 432 gms

JULLUNDUR ENTERPRISES

ICE PACK

MODEL NO.12



Icepack of 0.6 litre capacity MODEL NO.12

- Material : HDPE (High Density Polyethylene)
- WHO PQS code : E005/006
- Size : 0.6 Litres
- Volume of Ice per pack : 0.570 Litres
- External dimensions (Approx.): 190x119x35 mm
- Weight empty : 110 gms
- Weight Filled : 664 gms

JULLUNDUR ENTERPRISES

At Glance
Product Glossary

 **JULLUNDUR ENTERPRISES**

 **MEDIGUARD** TM ISO 9001-2008
CE

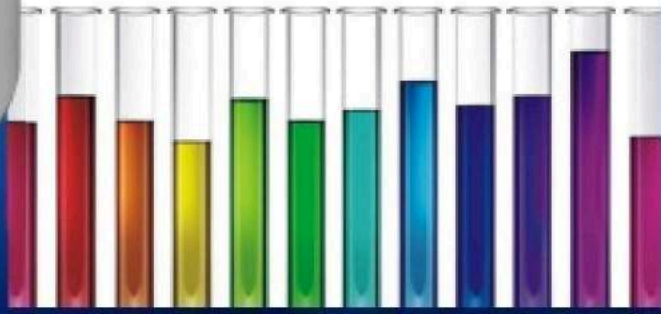



B.O.D. Incubator



Hot Air Oven



Incubators Bacteriological



Mortuary Chamber



Lyophilizer



Deep Freezer - 86°C



Laminar Flow Cabinet



Fume Hood



Water Bath Rectangular



VDRL-Shaker



Heating Mantle



Hot Plate



Vertex Shaker



Magnetic-Stirrer



Distillation Apparatus



Laboratory Stirrer



Autoclave Portable (Single Walled)



Autoclave Vertical Radial Locking (Double Walled)



Horizontal Cylindrical High Pressure (Double/Triple Walled)



Autoclave Vertical (Triple Walled)



Rectangular High Pressure (Triple Walled)



Doctor Centrifuge



Doctor Centrifuge



Doctor Centrifuge



Medico Centrifuge



Medical Centrifuge



Rectangular Centrifuge



universal centrifuge



hand centrifugal



Microscope Binocular



Mixer Grinder



Organ Bath



Hardness Tester



Spirometer



Coating Pan



Tube filling Machine



Overhead Projector



Microtome (Spencer Type)



Kymograph



Abbe Refractometer



Lensometer



Resistance Boxes



Rheostate



Chemical Balance



Weight Box



Round Spring Balance



Rectangular Spring Balance



Round Spring Balance



Round Baby Spring Balance



Acrylic Liquid Balance



Yellow Liquid Balance



Green Liquid Balance



Silver Liquid Balance



Baby Balance



Platform Scale



Brass Pocket Balance



Plastic Pocket Balance



Triple Beam Balance



Slotted Weight



Model of Engine



Crm Meter



Glass Beakers



Zener Diode



Boss Head



All Types of Clamp



Vernier Scale



Micrometer



Burette



Digital Photo Colorimeter



ADDRESS : 1568-A, G-22,23, Bhagirath Palace, Delhi-110006 (INDIA)
 PHONE : 011-23860035, 011-23860283
 MOBILE : +91 9871432046, +91-9312281439, +91-9810660343
 EMAIL : info@jemediguard.com
 WEBSITE : www.jemediguard.com



**MANUFACTURER & EXPORTER
BIO MEDICAL
WASTE EQUIPMENT**



JULLUNDUR ENTERPRISES



JULLUNDUR ENTERPRISES

BIO MEDICAL WASTE EQUIPMENT CATALOG



2018 **PRODUCT CATALOGUE**

PADDLE DUSTBIN



HEAVY PLASTIC PADDLE DUSTBIN

Size : 10 Ltr.

Material : PP/CP Injection Moulded

Dimension : L26.8 x W24.2 x H28.5 cm

- Foot Pedal for hands free opening & closing of lid

Available in colour coding options of Red, Blue, Black, Yellow, Green



HEAVY PLASTIC PADDLE DUSTBIN

Size : 16 Ltr.

Dimension : D305 x W305 x H356mm

Material : PP/CP Injection Moulded

- Foot Pedal for hands free opening & closing of lid
- Shock & Penetration resistant

Available in colour coding options of Red, Blue, Black, Yellow, Green



HEAVY PLASTIC PADDLE DUSTBIN

Size : 21 Ltr.

Dimension : D420 x W180 x H480mm

Material : PP/CP Injection Moulded

- Foot Pedal for hands free opening & closing of lid
- Shock & Penetration resistant

Available in colour coding options of Red, Blue, Black, Yellow, Green



HEAVY PLASTIC PADDLE DUSTBIN

Size : 22 Ltr.

Dimension : D280 x W280 x H435mm

Material : PP/CP Injection Moulded

- Foot Pedal for hands free opening & closing of lid
- Shock & Penetration resistant

Available in colour coding options of Red, Blue, Black, Yellow, Green



HEAVY PLASTIC PADDLE DUSTBIN

Size : 32 Ltr.

Dimension : D455 x W295 x H495mm

Material : PP/CP Injection Moulded

Available in colour coding options of Red, Blue, Black, Yellow, Green



2 WHEEL PADDLE DUSTBIN

Size : 55 Ltr.

Dimension : D430 x H630mm

Material : PP/CP Injection Moulded

- Foot Pedal for hands free opening & closing of lid
- Foot Pedal with Two Wheels

Available in colour coding options of Red, Blue, Black, Yellow, Green



2 WHEEL PADDLE DUSTBIN

Size : 65 Ltr.

Dimension : H724 x L286 x W301mm

Material : PP/CP Injection Moulded

- Foot Pedal for hands free opening & closing of lid
- Foot Pedal with Two Wheels

Available in colour coding options of Red, Blue, Black, Yellow, Green



WASTE BIN WITH FOOT PADDLE & WHEELS

Size : 120 Ltr.

Material : HDPE

- Metal Foot Pedal for hands free opening & closing of lid
- Wheels & Handle for easy movement of waste bin
- Shock & Penetration resistant
- UV resistant.

Available in colour coding options of Red, Blue, Black, Yellow, Green



PADDLE DUSTBIN & RECYCLE BIN

STAINLESS STEEL PADDLE BIN



Size : 5 Ltr., 7 Ltr.

Material : Stainless Steel

- Foot Pedal for hands free opening & closing of lid

Available in colour coding options of Red, Blue, Black, Yellow, Green



WASTE BINS WITH FOOT PADDLE (WITHOUT WHEELS)



- Body made of Stainless Steel
- Inner Bins made of Virgin Plastic
- Very useful as can be kept at patient BED Side
- Each bin capacity 5 Liters
- Total three bin capacity 15 liters
- With Foot pedal for hands free operation

Available in colour coding options of Red, Blue, Black, Yellow, Green



RECYCLE BIN DUO



Size : D406 x W813 x H813mm

Capacity : 60ltr. Bucket each

Colour : White, Grey, Blue or Any

Material : FRP Dustbin & Plastic

RECYCLE BIN TRIO



Size : D406 x H813 x W1219mm

Colour : White, Grey, Blue or Any

Material : FRP Dustbin & Plastic

SYRINGE DESTROYER & SHARP CONTAINERS

NEEDLE CUM SYRINGE HUB DESTROYER

Destroys Syringe Hub & Needle in Single Action



3ltr.



0.8 ltr.

Electric Needle Cutter



PUNCTURE PROOF SHARPS CONTAINERS



0.8 & 1Ltr.



3 Ltr.



5 Ltr.

PLASTIC TRAY & DISPOSABLE CORRUGATED BOX

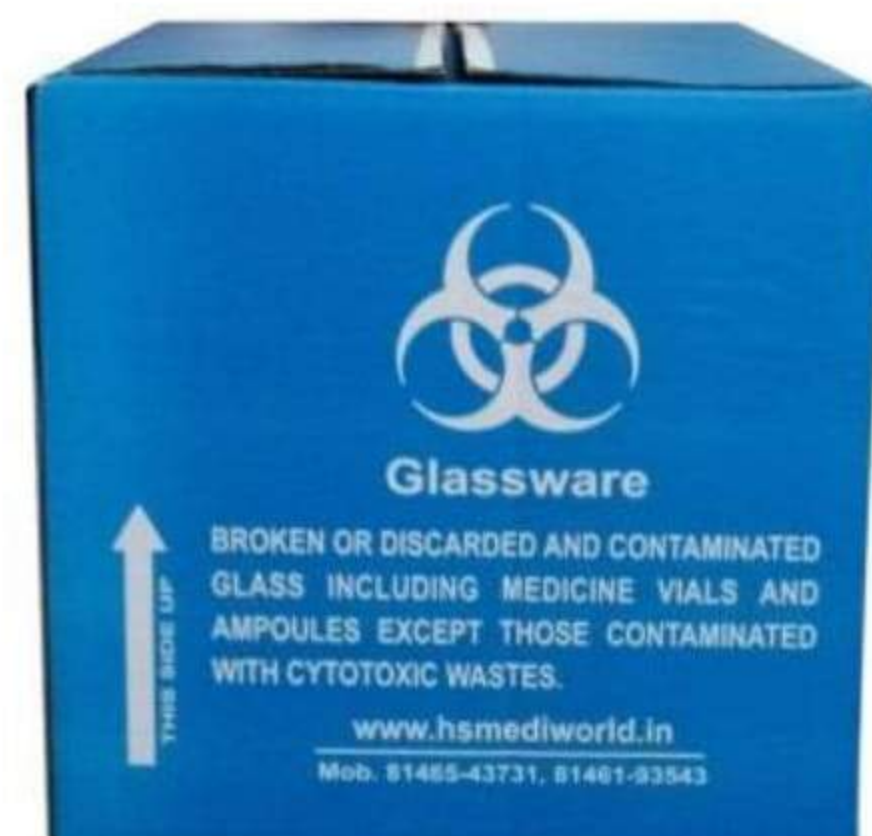

BIO MEDICAL WASTE SEGREGATION TROLLEY

WASTE SEGREGATION TROLLEYS (STAINLESS STEEL)

Dustbin Size : 16 Ltr.

- One, two, three and four compartment waste segregation system
- Stainless steel trolley on wheels
- Foot operating system for touchless opening of lid
- Bins can be interchanged as and when required



Available in colour coding options of Red, Blue, Black, Yellow, Green, White



WASTE SEGREGATION TROLLEYS (STAINLESS STEEL)

Dustbin Size : 32 Ltr.

- One, two, three and four compartment waste segregation system
- Stainless steel trolley on wheels
- Foot operating system for touchless opening of lid
- Bins can be interchanged as and when required



Available in colour coding options of Red, Blue, Black, Yellow, Green, White



WASTE SEGREGATION TROLLEYS (MILD STEEL & STAINLESS STEEL)

Dustbin Size : 30 Ltr. & 60 Ltr.



- One, two, three and four compartment waste segregation system
- Stainless steel trolley on wheels
- Foot operating system for touchless opening of lid
- Bins can be interchanged as and when required

Available in colour coding options of Red, Blue, Black, Yellow, Green



WASTE SEGREGATION COLLECTION TROLLEY (MILD STEEL)



- Four compartment waste segregation system
- Mild steel trolley on wheels
- Two stainless steel handle for easy moving

Available in colour coding options of Red, Blue, Black, Yellow, Green, White



WASTE SEGREGATION COLLECTION TROLLEY (STAINLESS STEEL)



- Three compartment waste segregation system
- Stainless steel trolley on wheels
- Two stainless steel handle for easy moving

Available in colour coding options of Red, Blue, Black, Yellow, Green, White



HYPODROP™

"Treats Your Liquid Medical Waste"



- Manual liquid waste treatment system at the point of its generation.
- Liquid waste gets collected directly into waste treatment unit having level indicator to avoid overflowing.
- Level indicators for waste water and sodium hypo chloride.
- Manual draining of treated waste to sewage line.
- Treats waste as per the pollution control board gridlines.
- The machine treats the liquid waste 40 ltr.

- Manual liquid waste treatment system at the point of its generation.
- The equipment has washing bay.
- Liquid waste gets collected directly into waste treatment unit having level indicator to avoid overflowing.
- Level indicators for waste water and sodium hypo chloride.
- Manual draining of treated waste to sewage line.
- Treats waste as per the pollution control board gridlines.
- The machine treats the liquid waste 65 ltr.

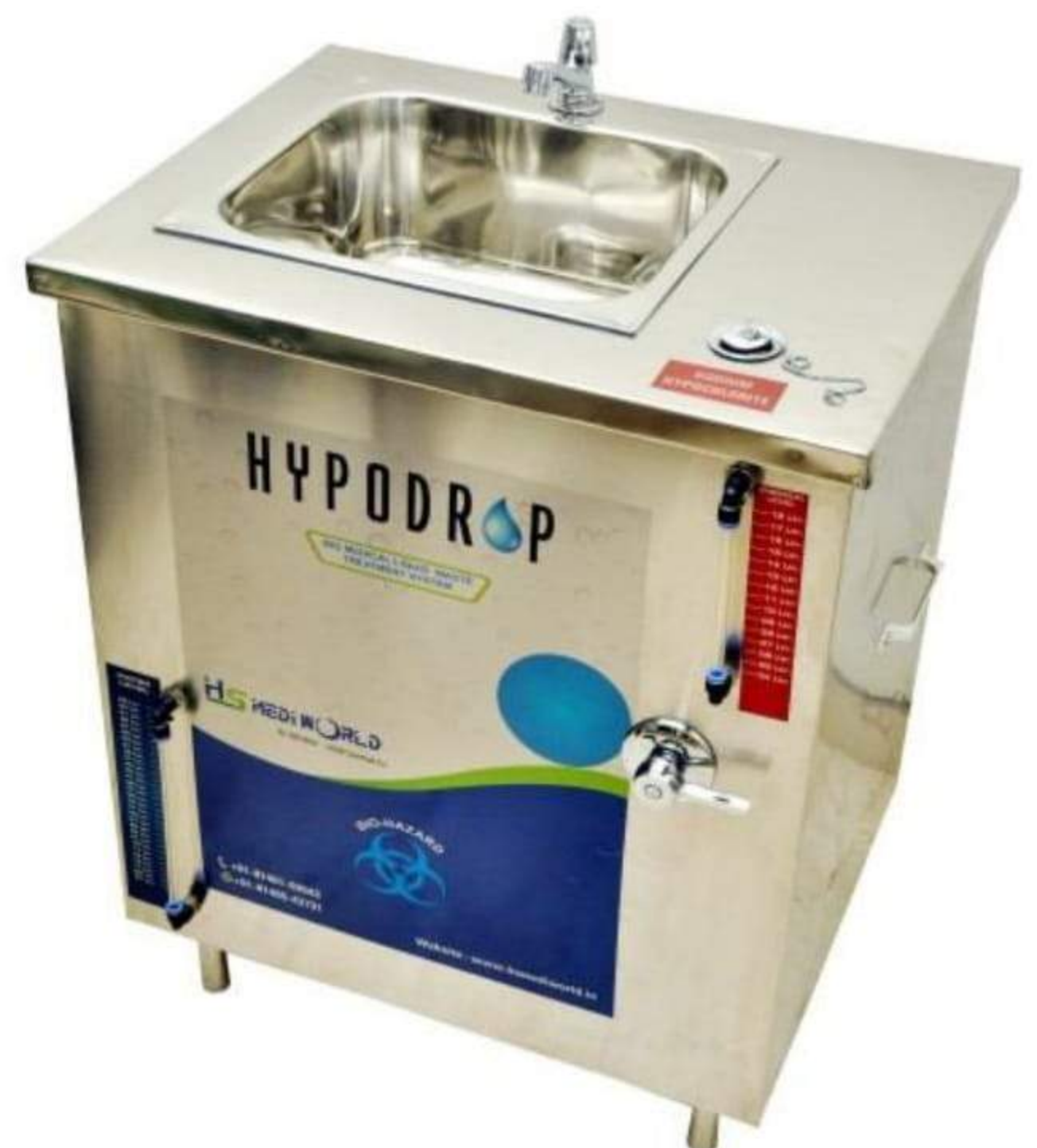

JE JULLUNDUR ENTERPRISES

JE MEDIGUARD[®]



APPROVED BY:



MANUFACTURER & EXPORTER OF MEDICAL DIAGNOSTIC X-RAY EQUIPMENT

SERIES 100



Parameters	100 P	100 M	100	3.5	10R
Type of Generator	2 pulse, Full Wave Rectified	2 pulse, Full Wave Rectified	2 pulse, Full Wave Rectified	Multi pulse, High Frequency	Multi pulse, High Frequency
Output Power	8 kW	8 kW	8 kW	3.5 kW	10 kW
X-Ray Tube	Stationary	Stationary	Stationary	Stationary	Rotating
Max. mA Output	100 mA	100 mA	100 mA	100mA	150mA
APR	Not Provided	Available (on demand)	Available (on demand)	Provided	Provided
Compatible Tube Stands	Portable Stand	Mobile Stand	Floor to Ceiling Stand	Mobile/Fix Stand	Mobile/Fix Stand

100 series Power Supply : 230 V AC, 50/60 Hz (as per frequency available)

SERIES 300 TO 500



Parameters	300	500	15	32	HF
Type of Generator	2 pulse, Full Wave Rectified	2 pulse, Full Wave Rectified	Multi pulse, High Frequency	Multi pulse, High Frequency	Multi pulse, High Frequency
Output Power	24 kW	40 kW	15 kW	32 kW	40 kW
X-Ray Tube	20/40 Rotating Anode	20/40 Rotating Anode	20/40 Rotating Anode	20/40 Rotating Anode	20/40 Rotating Anode
Max. mA Output	300mA	500mA	300mA	500mA	600mA
APR	Provided	Provided	Provided	Provided	Provided
Compatible Tube Stands	Floor To Ceiling Stand	Floor To Ceiling Stand	Floor To Ceiling Stand	Floor To Ceiling Stand	Floor To Ceiling Stand

300 to 500 series Power Supply : 440 V AC, 50/60 Hz (as per frequency available)

OTHER PRODUCTS & ACCESSORIES

(Dental X - Ray Machine)



VIVIX-S 1717V I
(X - Ray Detector)



X-RAY ACCESSORIES



PROTECTIVE SCREEN



MEDICAL APRON



X-LEAD APRON STAND



X-RAY VIEW BOX



FILM HANGER FOR DEVELOPING

JULLUNDUR ENTERPRISES

1568-A, G-22-23, BHAGIRATH PALACE
DELHI 110006, INDIA

Mobile : +91 9871432046 / +91 9999329288

Email : info@jemediguard.com

Manufacturers of :
Naturopathy, Hydro Therapy, Yoga, Ayurvedic Panchakarma, Spa,
Physiotherapy, Gym, Fitness & Allied Equipments.

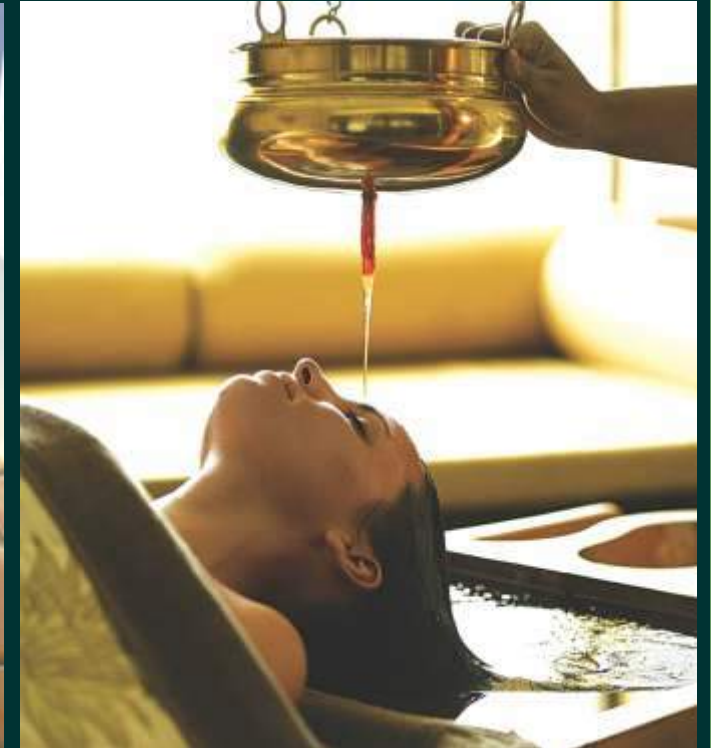

Naturopathy & Hydrotherapy Equipments

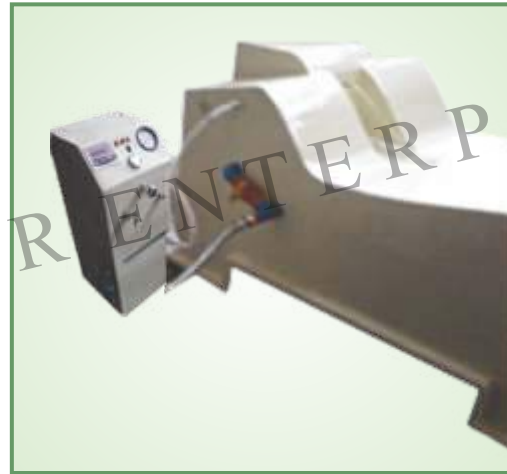

Code No : 101
 Name : Colon Machine Unit (Super Deluxe)
 Size : 90"x50"x42"
 Made of : Fibre Glass

Code No : 102
 Name : Colon Machine
 Size : 17"x17"x35"
 Made of : Fibre Glass



Code No : 103
 Name : Colon Bed
 Size : 72"x32"x42"
 Made of : Fibre Glass

Code No : 104
 Name : Colon Kit
 Size :
 Made of : PVC / Rubber

- * Water Filter (5 Stages) System with Ultra Violet Chamber.
- * In Built water heating with indirect Electrical Wave System.
- * Pressure Control Valve and Earth Leakage Circuit Breaker (ELCB).
- * Temperature display with auto cut and remote control.
- * Special colon Treatment bed with Waste view tube.
- * Water flush point with hand shower.
- * Speculum Kit for easy insertion.
- * Optional-web cam system with led screen drainage view.
- * Back & leg rest in comfortable position
- * Specially designed lithony position in bed for colon hydrotherapy treatment
- * Speculum kit with small nozzle for easy insertion.
- * Two type of speculum we are used in this machine

Naturopathy & Hydrotherapy Equipments



Code No : 105
Name : Hip Bath Circular (Kati Snan) (Standard)
Size : 26" Dia x 28"H / 30" Dia x 35"H
Made of : Fibre Glass



Code No : 106
Name : Hip Bath Hospital Grade (Kati Snan)
Size : 36"x28"x24"
Made of : Fibre Glass



Code No : 107
Name : Hip Bath Hospital Grade (Kati Snan) (Big Size)
Size : 38"x30"x26"
Made of : Fibre Glass



Code No : 108
Name : Hip Bath (Kati Snan) (Deluxe)
Size : 40"x32"x24"
Made of : Fibre Glass



Code No : 109
Name : Hip Bath (Kati Snan) (4 in 1) Standard
Size : 40"x32"x24"
Made of : Fibre Glass



Code No : 110
Name : Hip Bath (Kati Snan) (4 in 1) Deluxe
Size : 40"x32"x24"
Made of : Fibre Glass

Naturopathy & Hydrotherapy Equipments



Code No : 111
 Name : Arm Bath (Standard)
 Size : 30"x17"x26"
 Made of : Fibre Glass

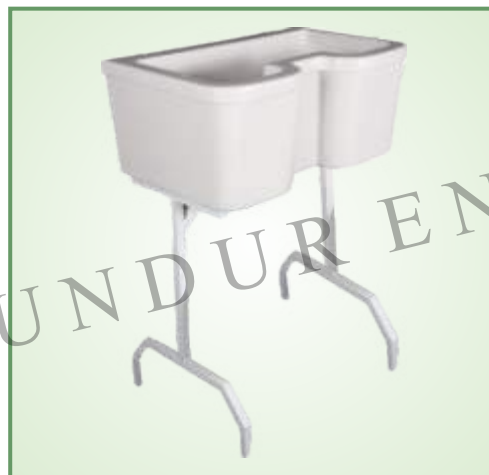

Code No : 112
 Name : Arm Bath (Deluxe)
 Size : 32"x19"x26"
 Made of : Fibre Glass



Code No : 113
 Name : Arm Bath (Super Deluxe)
 Size : 39"x38"x38"
 Made of : Fibre Glass



Code No : 114
 Name : Arm & Foot Joint (Standard)
 Size : 30"x20"x38"
 Made of : Fibre Glass



Code No : 115
 Name : Foot Bath (Standard)
 Size : 21"x20"x18"
 Made of : Fibre Glass



Code No : 116
 Name : Foot Bath (Deluxe)
 Size : 22"x20"x18"
 Made of : Fibre Glass



Code No : 117
 Name : Foot Bath (Super Deluxe)
 Size : 32"x32"x23"
 Made of : Fibre Glass



Code No : 118
 Name : Foot & Arm Joint (Deluxe)
 Size : 32"x32"x46"
 Made of : Fibre Glass

Naturopathy & Hydrotherapy Equipments



Code No : 119
 Name : Spinal Plane (Standard)
 Size : 42"x27"x10"
 Made of : Fibre Glass



Code No : 120
 Name : Spinal Plane (Deluxe)
 Size : 43"x28"x11"
 Made of : Fibre Glass



Code No : 121
 Name : Spinal Plane (Super Deluxe)
 Size : 52"x36"x17"
 Made of : Fibre Glass



Code No : 122
 Name : Spinal Spray (Plane Type) (Laydown)
 Size : 52"x36"x22"
 Made of : Fibre Glass



Code No : 123
 Name : Spinal Spray (Standard)(Laydown)
 Size : 44"x24"x30"
 Made of : Fibre Glass



Code No : 124
 Name : Spinal Spray (Deluxe)(Laydown)
 Size : 60"x24"x28"
 Made of : Fibre Glass



Code No : 125
 Name : Spinal Spray (Standard)(Sitting)
 Size : 44"x26"x40"
 Made of : Fibre Glass

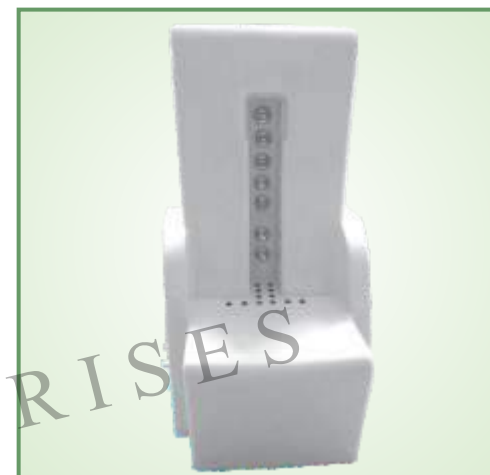

Code No : 126
 Name : Spinal Spray (Deluxe)(Sitting)
 Size : 42"x25"x39"
 Made of : Fibre Glass

Naturopathy & Hydrotherapy Equipments



Code No : 127
 Name : Local Jet Spray
 Size : 17"x17"x24"
 Made of : Fibre Glass



Code No : 128
 Name : Local Jet Spray (Deluxe)
 Size : 30"x20"x36"
 Made of : Fibre Glass



Code No : 129
 Name : Circular Jet
 Size : 48"Diax84"H
 Made of : Stainless Steel



Code No : 130
 Name : Local Jet (Deluxe)
 Size : 48"Diax84"H
 Made of : Fibre Glass/PVC



Code No : 131
 Name : Circular Jet (Super Deluxe)
 Size : 48"Diax72"H
 Made of : Fibre Glass/SS



Code No : 132
 Name : Vichy Shower (Standard)
 Size : 84"x36"x Adjustable
 Made of : Fibre Glass



Code No : 133
 Name : Vichy Shower Unit (Deluxe)
 Size : 84"x36"x72"(Top)
 Made of : Fibre Glass

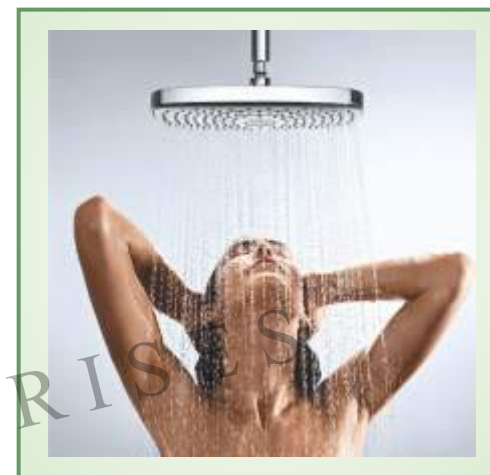

Code No : 134
 Name : Chill Shower
 Size : On Demand
 Made of : Stainless Steel

Naturopathy & Panchkarma Equipments



Code No : 135
Name : Mud Bath Tub
Size : 84"x36"x20"
Made of : Fibre



Code No : 136
Name : Enema Table (With Back Rest)
Size : 66"x24"x24"/18"
Made of : Fibre/Wood



Code No : 137
Name : Thermolium Sitting (Light Therapy)
Size : 42"x30"x50"
Made of : Fibre/Wood

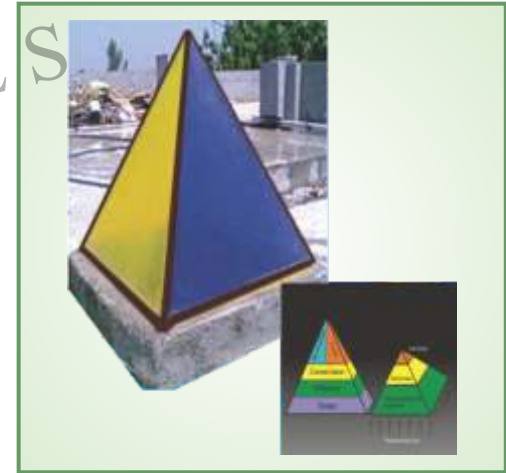

Code No. : 138
Name : Yoga Pyramid
Size : On Demand
Made of : Fibre/Acrylic/Glass



Code No : 139
Name : Local Steam (Nadi Swedan Yantra)
Size : 10 Ltr. to 20 Ltr.
Made of : SS/Aluminium



Code No : 140
Name : Mud Trey Set
Size : Standard
Made of : Fibre Glass

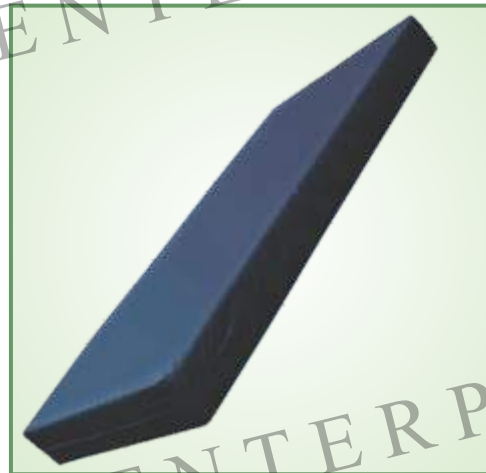

Code No : 141
Name : Metress
Size : On Demand
Made of : Synthetic Leather

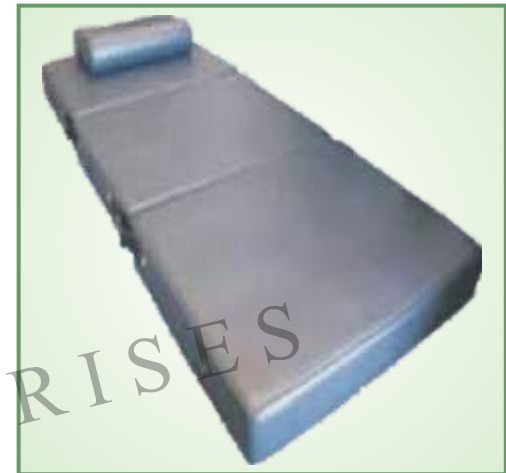

Code No : 142
Name : Megnatic Bed
Made of : Imported Leather

Naturopathy & Hydrotherapy Equipments



Immersion bath is meant for the whole body, which is having general relaxative effect.

This bath relaxes the whole body, invigorates the nerves, tonifies the muscles. In hot immersion bath the peripheral circulation increases considerably. This is indicated in Br. Asthma specially the asthma bath, Paralysis, Skin disorders, Poly-arthritis, Body Ache, Fatigue, Neurological disorders etc.

The water is made to swirl by the help of jets in this mode of treatment.



Code No : 143
Name : Full Immersion Tub (Standard)
Size : 72"x36"x26"
Made of : Fibre Glass



Code No : 144
Name : Full Immersion Tub (Deluxe)
Size : 72"x36"x26"
Made of : Fibre Glass



Code No : 145
Name : Zacuzzi (Deluxe)
Size : 72"x36"x28"
Made of : Fibre Glass (with accessories)



Code No : 146
Name : Under Water Massager (Deluxe)
Size : 72"x36"x28"
Made of : Fibre Glass (with accessories)

Naturopathy & Hydrotherapy Equipments

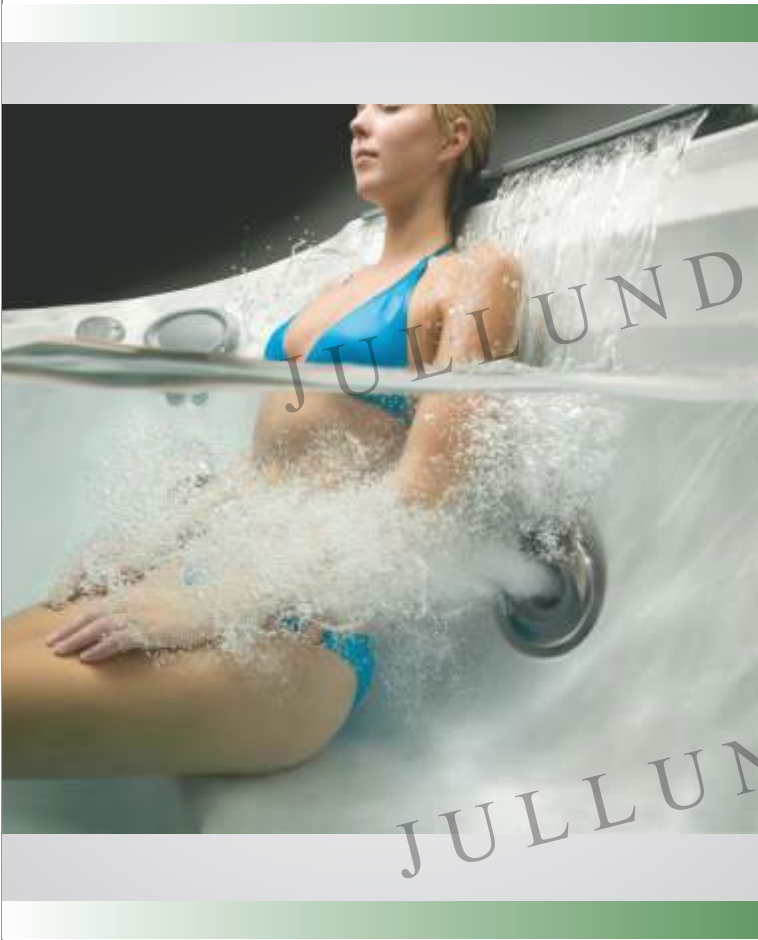

This is one of the special treatments, where the water is made to hit the body with definite force and pressure through the jets. This treatment invigorates the whole body, increases the blood circulation and stimulates the nerves and internal organs. Thus, it is helpful in general relaxation, paralytic conditions, nervous disorders, whole body pain etc.

The water is made to swirl by the help of jets in this mode of treatment. The whole body of a person is immersed in a standing position (except head). This also helps in inducing general relaxation, tones the nerves and muscles and increases the circulation.



Code No : 147
Name : Hydro Jet Massager (Deluxe)
Size : 96"x36"x30"
Made of : Fibre Glass (with accessories)



Code No : 148
Name : Hydro Jet Massager (Super Deluxe)
Size : 90"x36"x30"
Made of : Fibre Glass (with accessories)

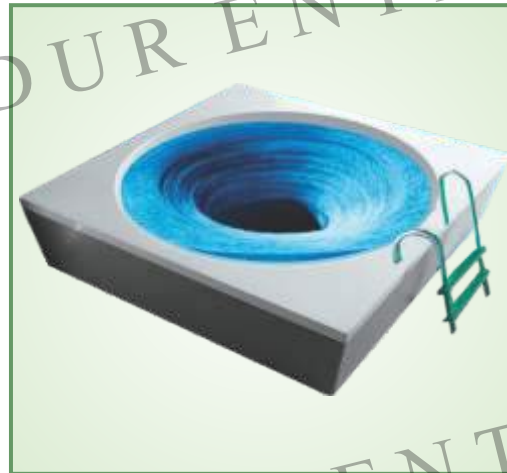

Code No : 149
Name : Whirlpool (Square)
Size : 60"x60"x60" (Inner Dia 48")
Made of : Fibre Glass



Code No : 150
Name : Whirlpool (Round)
Size : 60"x60"x60" (Inner Dia 48")
Made of : Fibre Glass

Naturopathy, Panchkarma & SPA Equipments



Code No : 151
Name : Sona Bath (Quick Heater)
Size : 60"x48"x84" (Two Sitting)
Made of : Pine Wood/Glass



Code No : 152
Name : Sona Bath (Quick Heater)
Size : 72"x72"x84" (Five to Six Sitting)
Made of : Pine Wood/Glass



Code No : 153
Name : Sona Bath (Stone Heater)
Size : 60"x48"x84" (Two Sitting)
Made of : Pine Wood/Glass



Code No : 154
Name : Sona Bath (Stone Heater)
Size : 72"x72"x84" (Five to Six Sitting)
Made of : Pine Wood/Glass



Code No : 155
Name : Steam & Shower (Single Sitting)
Size : 60" Half Round x 84"
Made of : Fibre/Acrylic/Glass



Code No : 156
Name : Steam Room (Two Sitting)
Size : 48"x48"x84"
Made of : Fibre/Acrylic/Glass



Code No : 157
Name : Steam Room (Five to Six Sitting)
Size : 72"x72"x84"
Made of : Fibre/Acrylic/Glass



Code No : 158 (Steam Generator)
Code No : 159 (Sauna Heater)
Code No : 160 (Control Panel)
Made of : Stainless Steel / PVC

Naturopathy & Panchkarma Equipments



Code No : 161
Name : Steam Cabin (Sitting)
(Vashpa Swedan Yantra)
Size : 36"x 26"x48"
Made of : Fibre Glass



Code No : 162
Name : Steam Cabin (Sitting)
(Vashpa Swedan Yantra)
Size : 38"x 30"x48"
Made of : Fibre Glass (Automatic)



Code No : 163
Name : Steam Cabin (Sitting)
(Vashpa Swedan Yantra)
Size : 37"x 28"x48"
Made of : Wooden



Code No : 164
Name : Steam Cabin (Laydown)
(Sarvang Vashpa Swedan Yantra)
Size : 90"x 32"x45"
Made of : Fibre Glass



Code No : 165
Name : Panchkarma Table
Size : 90"x 32"x44"
Made of : Fibre Glass



Code No : 166
Name : Steam Cabin (Laydown)
(Sarvang Vashpa Swedan Yantra)
Size : 84"x 32"x44"
Made of : Wood



Code No : 167
Name : Steam Cabin (Laydown)
(Sarvang Vashpa Swedan Yantra)
Size : 84"x 32"x44"
Made of : Wood



Code No : 168
Name : Panchkarma Table
Size : 90"x 32"x44"
Made of : Wood



Code No : 169
Name : Steamer
Size : 20 Ltr. to 25 Ltr
Made of : SS/Alumunium



Code No : 170
Name : Steamer
Size : 10 Ltr to 12 Ltr
Made of : SS/Alumunium

Naturopathy & Panchkarma Equipments



Code No : 171
Name : Shirodhara cum Massage Table
Size : 84"x 33"x30"
Made of : Fibre Glass



Code No : 172
Name : Shirodhara Table (Patti)
Size : 96"x 28"x30"
Made of : Fibre Glass



Code No : 173
Name : Shirodhara Table (Droni)
Size : 96"x 30"x30"
Made of : Fibre Glass



Code No : 174
Name : Shirodhara Table (Droni) (Adjustable)
Size : 96"x 30"x30"
Made of : Fibre Glass



Code No : 175
Name : Shirodhara Table
Size : 90"x 30"x30"
Made of : Wooden



Code No : 176
Name : Shirodhara Table (Deluxe) (With Drawer)
Size : 96"x 30"x30"
Made of : Wooden



Code No : 177
Name : Shirodhara Table (Adjustable) (Up-Down)
Size : 90"x 30"x30"
Made of : Wooden/M.S. Powder Coated



Code No : 178
Name : Shirodhara Table (With Shirodhara Machine) (Up-Down)
Size : 90"x 30"x30"
Made of : Wooden/M.S. Powder Coated



Code No : 179
Name : Sarwangdhara Table (With Shirodhara Machine)
Size : 90"x 30"x30"
Made of : Wooden/SS



Code No : 180
Name : Shirodhara Machine
Size : 30"x 20"x18"
Made of : M.S. Powder Coated

Naturopathy & Panchkarma Equipments



Code No : 181
 Name : Shirodhara Stand (Super)
 Size : 22"x20"x80"
 Made of : Fibre Glass



Code No : 182
 Name : Shirodhara Stand (Eco)
 Size : 22"x20"x80"
 Made of : Wooden



Code No : 183
 Name : Shirodhara Stand (Four Leg)
 Size : 20"x20"x80"
 Made of : Wooden



Code No : 184
 Name : Shirodhara Stand (Head Rest)
 Size : 22"x20"x80"
 Made of : Wooden



Code No : 185
 Name : Shirodhara Stand (With Drawer)
 Size : 24"x24"x80"
 Made of : Wooden



Code No : 186
 Name : Shirodhara Stand (Automatic)
 Size : B-30/T-36"x20"x80"
 Made of : Wooden



Code No : 187
 Name : Shirodhara Patra
 Capacity : 2 Ltr. or 2.5 Ltr.
 Made of : Stainless Steel & Brass Coated



Code No : 188
 Name : Shirodhara Patra
 Capacity : 4 Ltr. or 5 Ltr.
 Made of : Brass

Naturopathy, Panchkarma & SPA Equipments



Code No : 189
Name : Massage Table
Size : 77"x28"x32"
Made of : Fibre Glass/M.S. Powder Coated



Code No : 190
Name : Massage Table (Square)
Size : 78"x30"x32"
Made of : M.S. Powder Coated/Synthetic Leather



Code No : 191
Name : Massage Table (Round)
Size : 78"x30"x32"
Made of : M.S. Powder Coated/Synthetic Leather



Code No : 192
Name : Massage Table (Standard)
Size : 78"x30"x32"
Made of : Wooden/Synthetic Leather



Code No : 193
Name : Massage Table (Deluxe) (With Drawer)
Size : 78"x30"x32"
Made of : Wooden/Synthetic Leather

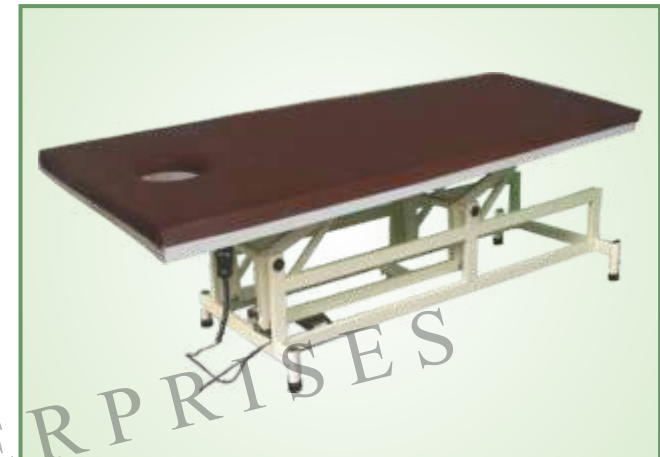

Code No : 194
Name : Massage Table (Up-Down Adjustable Base Frame)
Size : 78"x30"x32"
Made of : M.S. Powder Coated

Panchkarma Equipments



Code No : 195
Name : Virechan Chair
 (Virechan Peeth)
Size : 30"x 24"x37"
Made of : Wooden/Fibre/SS



Code No : 196
Name : Rectum Steam Chair
 (Arsh Bashpa Sweda
 Yanthram)
Size : 23"x 25"x37"
Made of : Wooden/Fibre/SS



Code No : 197
Name : Vaman Peeth
Size : 36"x 36"x32"
Made of : SS/M.S. Powder Coated



Code No : 198
Name : Nasya Chair
 (Nasya Peeth)
Size : 41"x 25"x26"
Made of : Wood/SS/
 M.S. Powder Coated



Code No : 199
Name : Awagaha Tub
 (Awagaha Bath)
Size : 72"x 30"x20"
Made of : Fibre Glass/SS/M.S.
 Powder Coated Sheet



Code No : 200
Name : Panchkarma Patra
 Panchkarma Accessories
Size : 40"x 32"x44"
Made of : Brass & Bronze



Code No : 201
Name : Siro Vasti Cap
Size : 32"x8"
Made of : Synthetic Leather



Code No : 202
Name : Vasti
Made of : SS/Synthetic Leather



Code No : 203
Name : Syringe (Mathra Vasti/
 Thaila Vasti Yantram)
Size : 32"x8"
Made of : Metal & PVC



Code No : 204
Name : Oil Heater
Made of : Imported Metal

Naturopathy, Panchkarma & SPA Equipments



Code No : 205
Name : Full Body Massage Chair
Made of :



Code No : 206
Name : Vibro Massager
Made of :



Code No : 207
Name : Stone Therapy
Made of :



Code No : 208
Name : Detox Machine (Foot SPA)
Made of :



Code No : 209
Name : Full Body Steamer (Hot & Cold)
Made of :



Code No : 210
Name : Facial Sauna (Face Steam)
Made of :



Code No : 211
Name : Facial Steamer (Standing)
Made of :



Code No : 212
Name : Head Steamer (Standing)
Made of :

Sporting Items



Code No : 214
Name : Stool (Adjustable)
Made of : Fibre Glass



Code No : 215
Name : Stool (Fancy)
Made of : Fibre Glass



Code No : 216
Name : Stool (With Leg Rest)
Made of : SS & Synthetic Leather



Code No : 217
Name : Stool (Round) (Adjustable)
Made of : SS/PVC/Synthetic Leather



Code No : 218
Name : Stool (With Back Rest)
Made of : SS/PVC/Synthetic Leather



Code No : 219
Name : Foot Rest
Made of : Fibre Glass



Code No : 220
Name : Stepper
Made of : Fibre Glass



Code No : 221
Name : Foot Rest Single
Made of : Fibre Glass



Code No : 222
Name : Stepper (Two)
Made of : SS & M.S.



Code No : 223
Name : Stepper (Three)
Made of : SS & M.S.

Trolley



Code No : 224
Name : Trolley (Single Bowl)
Size : 24"x18"x32"
Made of : SS/M.S. Powder Coated



Code No : 225
Name : Trolley (Double Bowl)
Size : 24"x18"x32"
Made of : SS/M.S. Powder Coated



Code No : 226
Name : Trolley (Two Self)
Size : 24"x18"x32"
Made of : SS/M.S. Powder Coated



Code No : 227
Name : Trolley (Three Self)
Size : 24"x18"x32"
Made of : SS/M.S. Powder Coated



Code No : 228
Name : Trolley (With Drawer)
Size : 24"x18"x32"
Made of : SS/M.S. Powder Coated



Code No : 229
Name : Trolley (With big drawer)
Size : 24"x18"x32"
Made of : SS/M.S. Powder Coated



Code No : 230
Name : Trolley (Zig Zag)
Size : 24"x18"x32"
Made of : Wood



Code No : 231
Name : Trolley (Simple)
Size : 24"x18"x32"
Made of : Wood



Code No : 232
Name : Trolley (Royal)
Size : 24"x18"x32"
Made of : Wood



Code No : 233
Name : Trolley (Multi)
Size : 18"x18"x32"
Made of : PVC



Foot bath is meant for the foot region, one of the important derivative treatments.

This is having a potent derivative effect in which the blood is derived from the upper portion of the body (including head) to the lower extremities and hence relieves congestion. This is indicated in Br. asthma, Sinusitis, Head ache, Hypertension, Cervical spondylosis, Diabetes, Arthritis of the ankle joint etc. The hot foot bath is also used as routine general relaxative treatment.



Code No : 234
Name : Pedi SPA Unit (Owel)
Size : 62"x29"x15"
Made of : Fibre Glass



Code No : 235
Name : Pedi SPA Unit (Square)
Size : 62"x29"x16"
Made of : Fibre Glass



Code No : 236
Name : Pedi SPA (Round)
Size : 18"x18"
Made of : Fibre Glass



Code No : 237
Name : Pedi SPA (Square)
Size : 18"x18"
Made of : Fibre Glass

SPA Equipments



Code No : 238
Name : Sampoo Station (Resty)
Size : 36"x22"x20"
Made of : Fibre Glass/Synthetic Leather



Code No : 239
Name : Sampoo Station (Royal)
Size : 36"x22"x20"
Made of : Fibre Glass/Synthetic Leather



Code No : 240
Name : Sampoo Station (Bird)
Size : 36"x22"x20"
Made of : Fibre Glass/Synthetic Leather



Code No : 241
Name : Sampoo Station (Spice)
Size : 36"x22"x20"
Made of : Fibre Glass/Synthetic Leather



Code No : 242
Name : Saloon Chair (Rainbow)
Size : Adjustable
Made of : Synthetic Leather



Code No : 243
Name : Saloon Chair (Cloud)
Size : Adjustable
Made of : Synthetic Leather



Code No : 244
Name : Saloon Chair (Jamboo)
Size : Adjustable
Made of : Synthetic Leather



Code No : 245
Name : Saloon Chair (Gold)
Size : Adjustable
Made of : Synthetic Leather

Sporting Items



Code No : 246
Name : Statue (Dhanwantri with Pot)
Size : On Demand
Made of : Fibre



Code No : 247
Name : Yoga Statue
Size : On Demand
Made of : Poly Stone



Code No : 248
Name : Yoga Statue (Hast Mudra)
Size : On Demand
Made of : Fibre Glass



Code No : 249
Name : Fountain (Buddha)
Size : On Demand
Made of : Fibre Glass



Code No : 250
Name : Fountain (Yogi)
Size : On Demand
Made of : Fibre Glass



Code No : 251
Name : Fountain (Step)
Size : On Demand
Made of : Fibre Glass



Code No : 252
Name : Changing Room
Size : On Demand
Made of : Fibre Glass



Code No : 253
Name : Toilet Room
Size : On Demand
Made of : Fibre Glass

INTRODUCTION : NATUROPATHY & PANCHKARMA



India is known for its age-old tradition and culture, which attracts the people from all corners of the globe. Besides, India is also known for its age-old time tested traditional health care system like Naturopathy and Yoga. These systems, once totally neglected, have drawn the attention of health seekers again. These systems not only have curative effect but more importantly health promotive & disease preventive effects. The entire world is looking for some alternative to the existing modern medical system, which failed to prove efficacious in several disease conditions. This has necessitated the modern system of medicine to integrate the traditional systems in health care delivery.

As increased affinity towards the natural way of living & the traditional methods of treatment is observed now-a-day, especially from the educated group. The reason is a new awareness about the wonderful role of Mother Nature in the fields of promotion of health & prolongation of healthy life is gradually developing.

Naturopathy is a system of healing science stimulating the body's inherent power to regain health with the help of five great elements of Nature-Earth, Water, Air Fire & Ether. Nature Cure principle believes that all the diseases arise due to accumulation of morbid matter in the body & if scope is given for removal of it provides a cure or relief. It also believes that the human body possesses inherent self-constructing & self-healing powers.

Though the basic Nature Cure deals only with Pancha Mahabhoota treatments, the recent developments advocate the practice of other drugless therapies like Massage, Electrotherapy, Physiotherapy, Acupuncture & Acupressure, Magneto therapy, Diet therapy, etc. the Yoga therapy also found places in nature Cure treatment modalities.

The Nature Cure movement gained momentum in India when Mahatma Gandhiji took interest. He not only preached the principles of Naturopathy to his fellow-beings but also adopted the same in his life.



Wooden Shade Card

Colour Shade Card

Note : ☞ On Demand facilities are also available like wooden look, Ceramic look & choice of different colours in fibre glass equipments.

Jullundur Enterprises is one of the leading manufacturer, supplier & exporter of

- **Surgical Instruments**
- **General Surgical Instruments**
- **Gynecology Surgical Instruments**
- **ENT Surgical Instruments**
- **Orthopedic Surgical Instruments**
- **Neuro Surgery Instruments**
- **Plastic Surgery Instruments**
- **Ophthalmic Surgical Instruments**
- **Cardio Vascular Surgical Instruments**
- **Veterinary Surgical Instruments)**
- **Medical Equipment**
- **Anesthesia Equipment (Anaesthesia Equipment)**
- **Surgical Holloware**
- **Medical Instrument Sterilizers**
- **Medical Autoclaves**
- **Suction Machines**
- **Surgical Rubber Products**
- **Medical Rubber Products**
- **Rehabilitation Aids / Ortho Aids**
- **Walking Aids**
- **Surgical Disposables**
- **Physiotherapy Equipment**
- **Slimming Equipment & Machines**
- **Hospital Linen**
- **Diagnostic Equipment / Instruments**
- **Weighing Machines**
- **Hospital Products**



JULLUNDUR ENTERPRISES



1568-A, G-22-23, Bhagirath Palace, Chandni Chowk Delhi-110006, India
Mob : +91- 9312281439/ +91- 9810660343/ +91- 9871432046
Email : info@jemediguard.com, Web : www.jemediguard.com